

N-Channel Enhancement Mode MOSFET

Features

- Fast switching speed
- Reliable and Rugged
- ROHS Compliant
- 100% UIS and Rg Tested

Applications

- Power Management in Desktop Computer
- DC/DC Converters

Pin Description

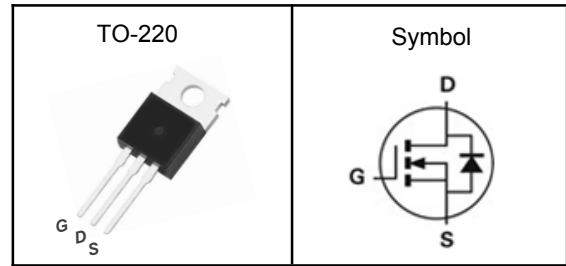

V_{DSS}	120	V
$R_{DS(ON)-Typ}$	10	m Ω
I_D	60	A

Absolute Maximum Ratings ($T_J=25^\circ\text{C}$, Unless Otherwise Noted)

Symbol	Parameter	N-Channel	Unit
V_{DSS}	Drain-Source Voltage	120	V
V_{GSS}	Gate-Source Voltage	± 20	V
T_J	Maximum Junction Temperature	-55 to 150	$^\circ\text{C}$
T_{STG}	Storage Temperature Range	-55 to 150	$^\circ\text{C}$
E_{AS}	Single Pulse Avalanche Energy ^③	290	mJ
$I_{DM}^{①}$	Pulse Drain Current Tested	240	A
I_D	Continuous Drain Current	$T_C=25^\circ\text{C}$	A
P_D	Maximum Power Dissipation	$T_C=25^\circ\text{C}$	W

Thermal Characteristics

Symbol	Parameter	Rating	Unit
$R_{\theta JC}$	Thermal Resistance Junction-Case ^①	1.4	$^\circ\text{C}/\text{W}$

Note ① : Max. current is limited by bonding wire.

Note ② : UIS tested and pulse width are limited by maximum junction temperature 150 $^\circ\text{C}$.

Note ③ : Surface Mounted on 1in² FR-4 board with 1oz.



N-Channel Enhancement Mode MOSFET

Electrical Characteristics ($T_J=25^{\circ}\text{C}$, Unless Otherwise Noted)

Symbol	Parameter	Test Conditions	Min	Typ	Max	Unit
Static Electrical Characteristics						
BV_{DSS}	Drain-Source Breakdown Voltage	$V_{GS}=0V, I_D=250\mu A$	120	---	---	V
I_{DSS}	Zero Gate Voltage Drain Current	$V_{DS}=120V, V_{GS}=0V$	---	---	1	μA
$V_{GS(th)}$	Gate Threshold Voltage	$V_{DS}=V_{GS}, I_D=250\mu A$	1	1.8	2.5	V
I_{GSS}	Gate Leakage Current	$V_{GS}=\pm 20V, V_{DS}=0V$	---	---	± 100	nA
$R_{DS(ON)}$	Drain-Source On-state Resistance	$V_{GS}=10V, I_D=30A$	---	10	11	$m\Omega$
Dynamic Characteristics ^⑤						
C_{iss}	Input Capacitance	$V_{GS}=0V,$ $V_{DS}=60V,$ Freq.=1MHz	---	2500	---	pF
C_{oss}	Output Capacitance		---	273	---	
C_{rss}	Reverse Transfer Capacitance		---	27	---	
$T_{d(on)}$	Turn-on Delay Time	$V_{DD}=50V, I_D=30A,$ $V_{GS}=10V, R_G=3\Omega$	---	11	---	nS
T_r	Turn-on Rise Time		---	7.5	---	
$T_{d(off)}$	Turn-off Delay Time		---	26	---	
T_f	Turn-off Fall Time		---	4	---	
g_{fs}	Forward Transconductance	$V_{DS}=5V, I_D=30A$	---	40	---	S
Q_g	Total Gate Charge	$V_{DS}=60V, V_{GS}=10V,$ $I_D=30A$	---	37	---	nC
Q_{gs}	Gate-Source Charge		---	14	---	
Q_{gd}	Gate-Drain Charge		---	8	---	
Source-Drain Characteristics ($T_J=25^{\circ}\text{C}$)						
V_{SD} ^④	Diode Forward Voltage	$I_F=60A, V_{GS}=0V$	---	---	1.2	V
t_{rr}	Reverse Recovery Time	$I_F=I_S, di/dt=100A\mu s,$ $T_J=25^{\circ}\text{C}$	---	58	---	nS
Q_{rr}	Reverse Recovery Charge		---	149	---	nC

Note ④ : Pulse test (pulse width $\leq 300\mu s$, duty cycle $\leq 2\%$).

Note ⑤ : Guaranteed by design, not subject to production testing.

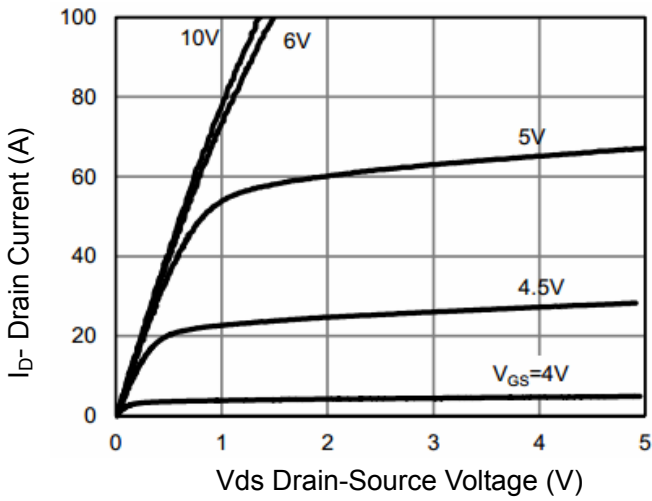
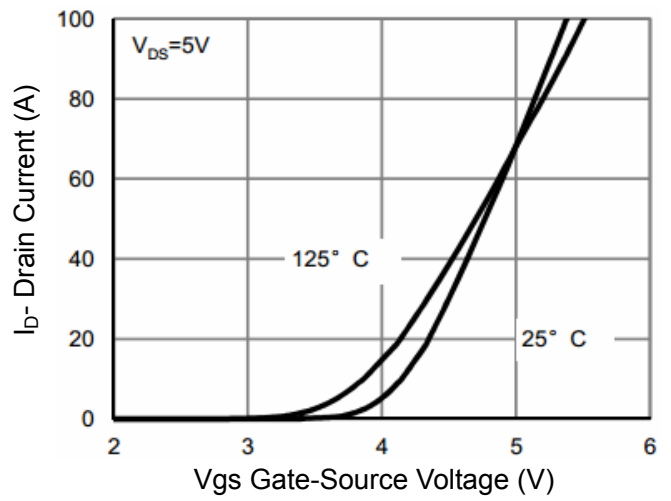
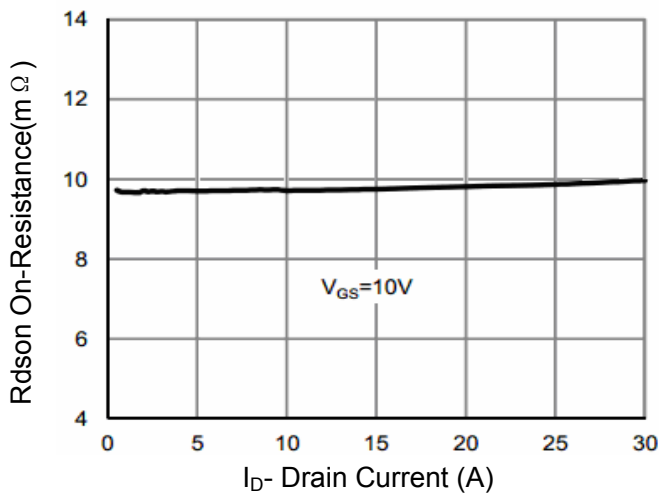
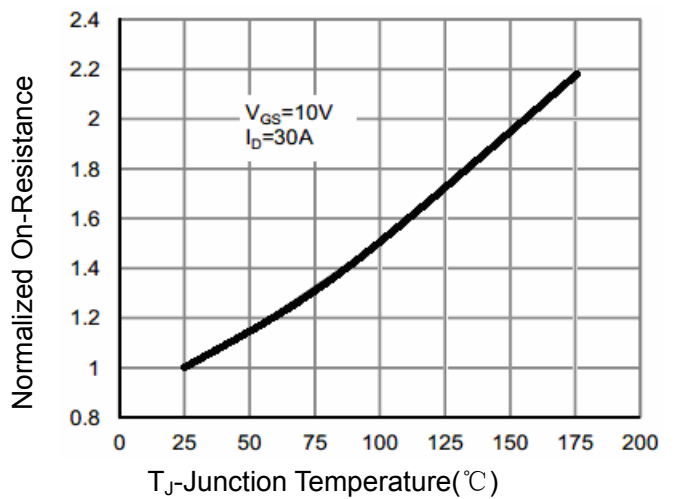
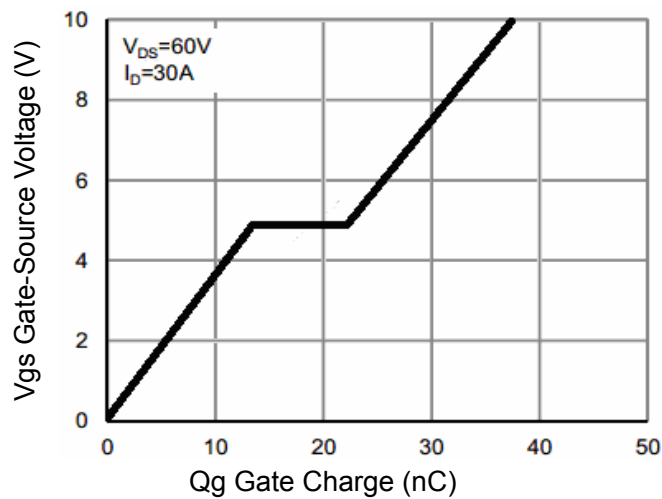
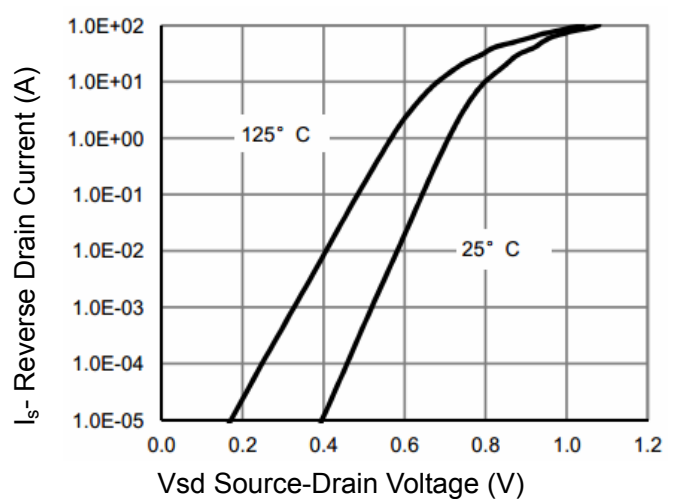
N-Channel Enhancement Mode MOSFET
Typical Characteristics

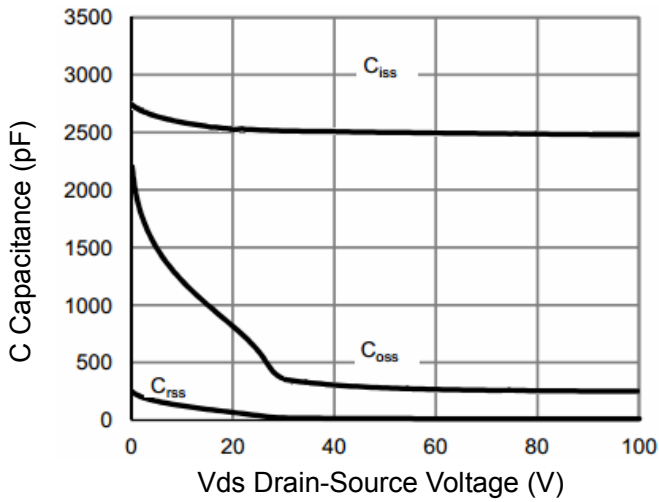
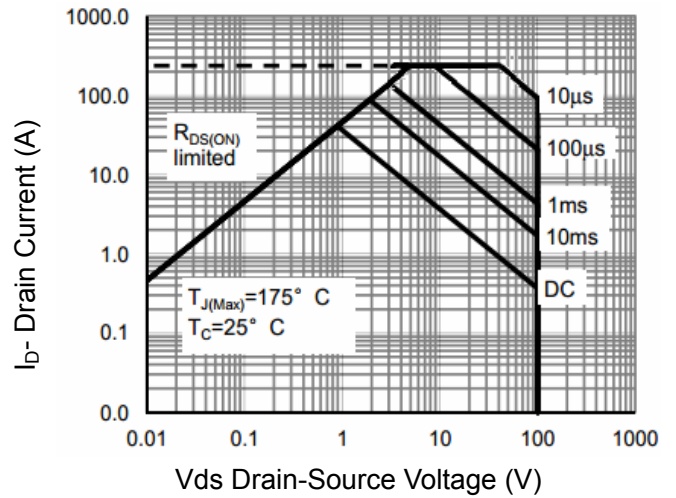
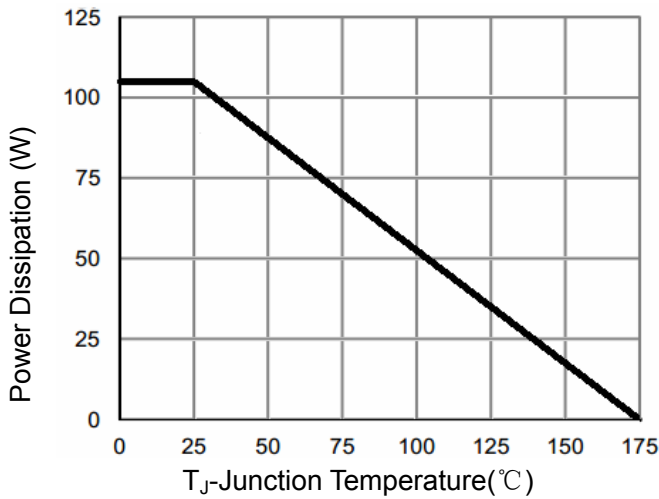
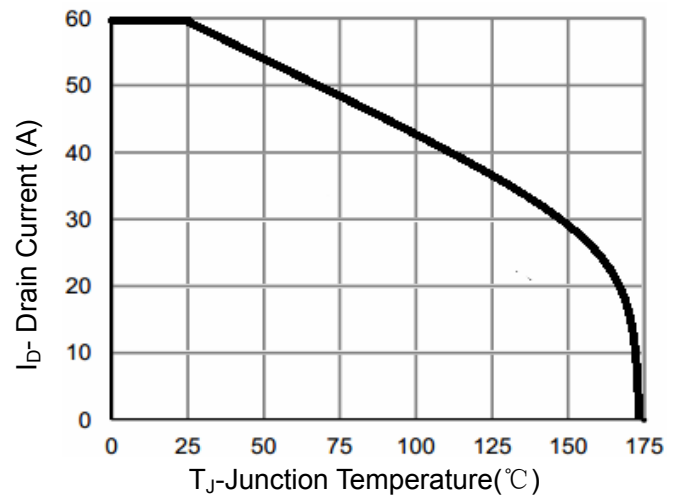
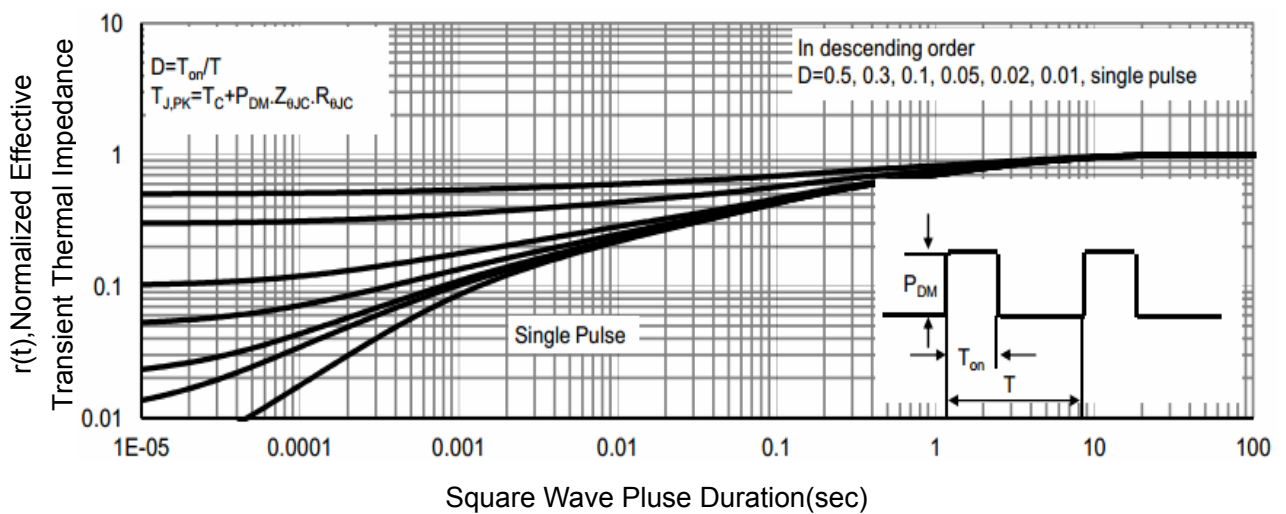
Figure 1 Output Characteristics

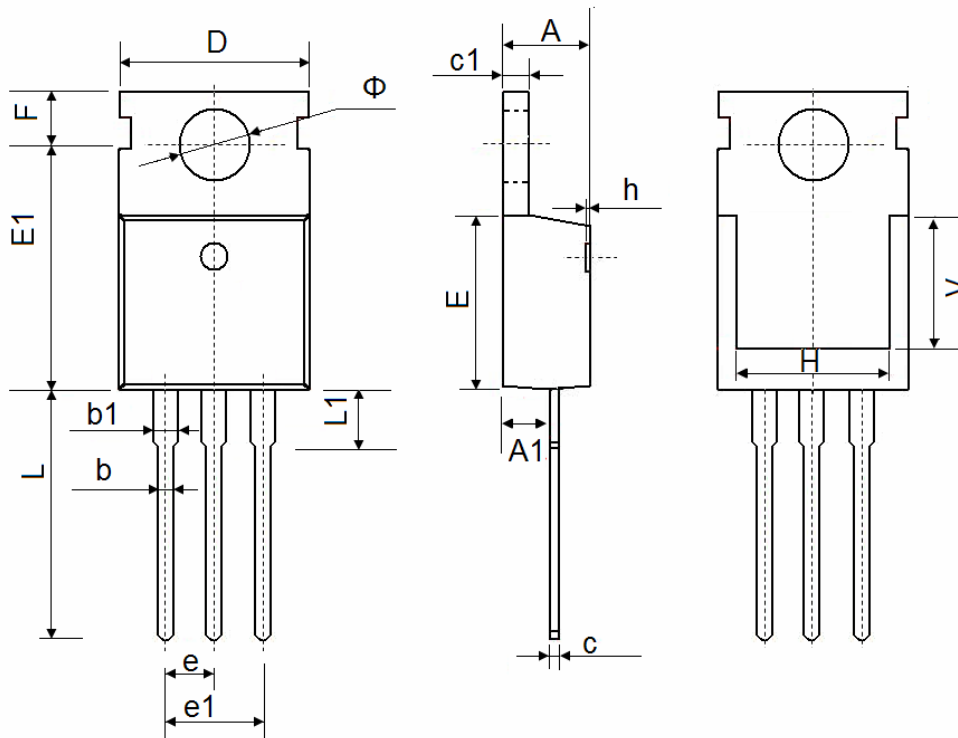
Figure 2 Transfer Characteristics

Figure 3 Rdson- Drain Current

Figure 4 Rdson-Junction Temperature

Figure 5 Gate Charge

Figure 6 Source- Drain Diode Forward

N-Channel Enhancement Mode MOSFET

Figure 7 Capacitance vs Vds

Figure 8 Safe Operation Area

Figure 9 Power De-rating

Figure 10 Current De-rating

Figure 11 Normalized Maximum Transient Thermal Impedance

N-Channel Enhancement Mode MOSFET
TO-220 Package Outline Data

Symbol	Dimensions In Millimeters	
	Min.	Max.
A	4.350	4.650
A1	2.250	2.550
b	0.710	0.910
b1	1.170	1.400
c	0.330	0.650
c1	1.200	1.400
D	9.910	10.250
E	8.9500	9.750
E1	12.650	12.950
e	2.540 TYP.	
e1	4.980	5.180
F	2.650	2.950
H	7.900	8.100
h	0.000	0.300
L	12.700	13.500
L1	2.850	3.250
V	7.500 REF.	
Φ	3.400	3.800