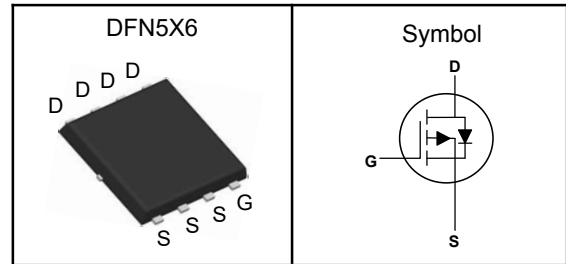

P-Channel Enhancement Mode MOSFET
Features

- Fast switching speed
- ROHS Compliant & Halogen-Free
- 100% UIS and Rg Tested

Applications

- Motor drivers
- DC - DC Converter

Pin Description

V_{DSS}	-100	V
$R_{DS(ON)-Typ}$	45	m Ω
I_D	-28	A

Absolute Maximum Ratings ($T_J=25^\circ\text{C}$, Unless Otherwise Noted)

Symbol	Parameter	N-Channel	Unit
V_{DSS}	Drain-Source Voltage	-100	V
V_{GSS}	Gate-Source Voltage	± 20	V
T_J	Maximum Junction Temperature	-55 to 150	$^\circ\text{C}$
T_{STG}	Storage Temperature Range	-55 to 150	$^\circ\text{C}$
$I_{DM}^{①}$	Pulse Drain Current Tested	-112	A
I_D	Continuous Drain Current	$T_C=25^\circ\text{C}$ -28	A
P_D	Maximum Power Dissipation	$T_C=25^\circ\text{C}$ 83	W
E_{AS}	Avalanche Energy, Single pulse	225	mJ

Thermal Characteristics

Symbol	Parameter	Rating	Unit
$R_{\theta JA}$	Thermal Resistance-Junction to Ambient	50	$^\circ\text{C}/\text{W}$
$R_{\theta JC}$	Thermal Resistance-Junction to Case	1.5	$^\circ\text{C}/\text{W}$

Note ① : Max. current is limited by bonding wire.

Note ② : UIS tested and pulse width are limited by maximum junction temperature 150°C .

Note ③ : Surface Mounted on 1in^2 FR-4 board with 1oz.



P-Channel Enhancement Mode MOSFET

Electrical Characteristics ($T_J=25^{\circ}\text{C}$, Unless Otherwise Noted)

Symbol	Parameter	Test Conditions	Min	Typ	Max	Unit
Static Electrical Characteristics						
BV_{DSS}	Drain-Source Breakdown Voltage	$V_{GS}=0V, I_D=-250\mu A$	-100	---	---	V
I_{DSS}	Zero Gate Voltage Drain Current	$V_{DS}=-100V, V_{GS}=0V$	---	---	-1	μA
$V_{GS(th)}$	Gate Threshold Voltage	$V_{DS}=V_{GS}, I_D=-250\mu A$	-1.2	---	-2.5	V
I_{GSS}	Gate Leakage Current	$V_{GS}=\pm 20V, V_{DS}=0V$	---	---	± 100	nA
$R_{DS(ON)}$	Drain-Source On-state Resistance	$V_{GS}=-10V, I_D=-20A$	---	45	55	m Ω
		$V_{GS}=-4.5V, I_D=-10A$	---	55	65	m Ω
Dynamic Characteristics ^⑤						
C_{iss}	Input Capacitance	$V_{GS}=0V, V_{DS}=-50V, \text{Freq.}=1\text{MHz}$	---	2100	---	pF
C_{oss}	Output Capacitance		---	169	---	
C_{rSS}	Reverse Transfer Capacitance		---	26	---	
$T_{d(on)}$	Turn-on Delay Time	$V_{GS}=-10V, V_{DS}=-50V, I_D=-20A, R_G=5\Omega$	---	10	---	nS
T_r	Turn-on Rise Time		---	19	---	
$T_{d(off)}$	Turn-off Delay Time		---	62	---	
T_f	Turn-off Fall Time		---	41	---	
Q_g	Total Gate Charge	$V_{GS}=-10V, V_{DS}=-50V, I_D=-20A$	---	38	---	nC
Q_{gs}	Gate-Source Charge		---	6	---	
Q_{gd}	Gate-Drain Charge		---	5	---	
Source-Drain Characteristics						
V_{SD} ^④	Diode Forward Voltage	$I_S=-20A, V_{GS}=0V$	---	---	-1.2	V
t_{rr}	Reverse Recovery Time	$I_F=-20A, V_{DD}=-50V, di_F/dt=100A/\mu s$	---	68	---	nS
Q_{rr}	Reverse Recovery Charge		---	200	---	nC

Note ④: Pulse test (pulse width $\leq 300\mu s$, duty cycle $\leq 2\%$).

Note ⑤: Guaranteed by design, not subject to production testing.

P-Channel Enhancement Mode MOSFET
Typical Characteristics
Typ. output characteristics

$$-I_D = f(-V_{DS})$$

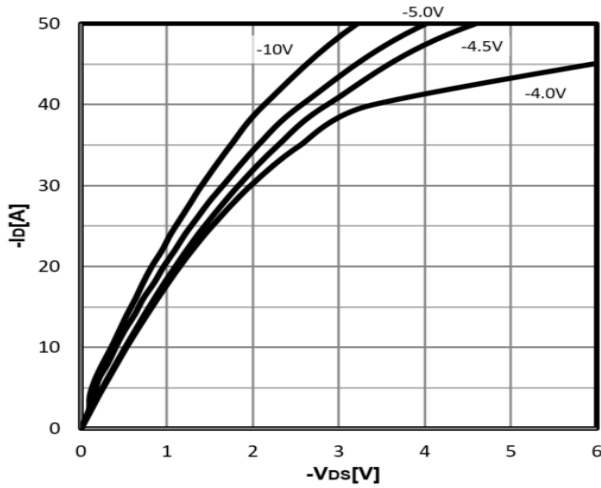
Typ. drain-source on resistance

$$R_{DS(on)} = f(-I_D)$$

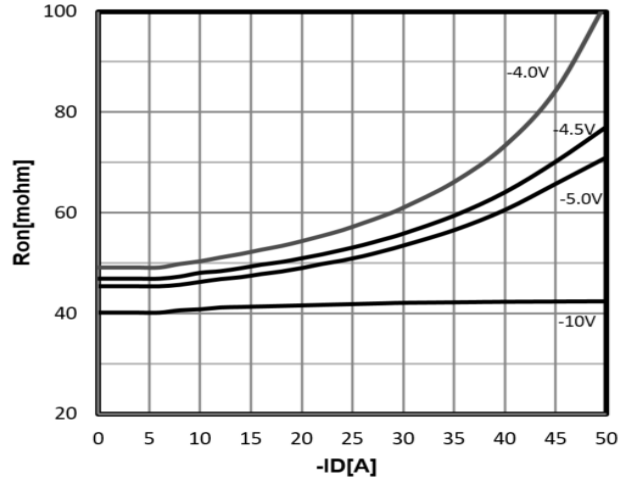
Typ. transfer characteristics

$$-I_D = f(-V_{GS})$$

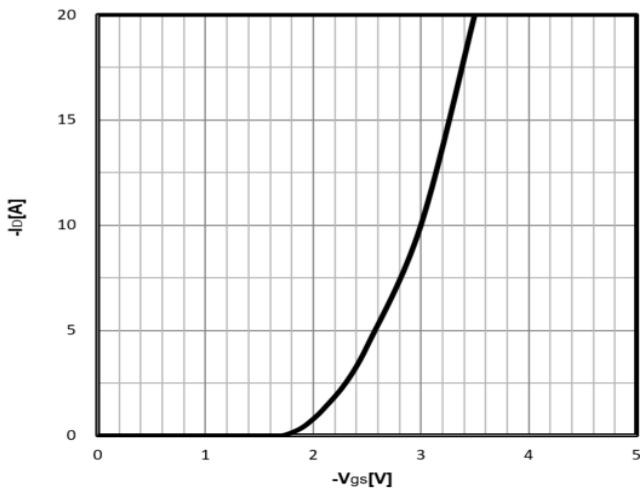
Drain-source on-state resistance

$$R_{DS(on)} = f(T_j); I_D = -20A; V_{GS} = -10V$$

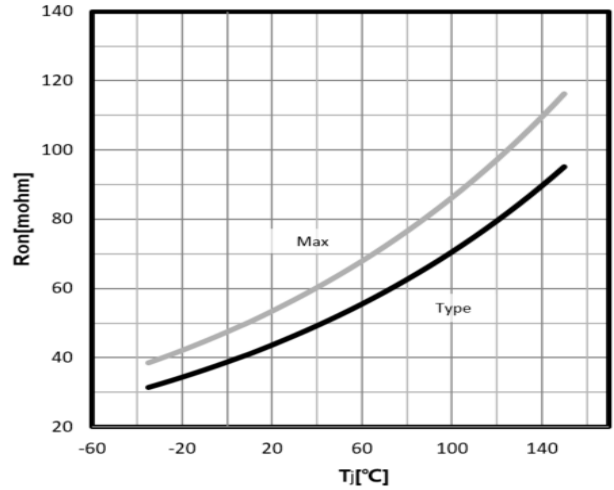

Gate Threshold Voltage

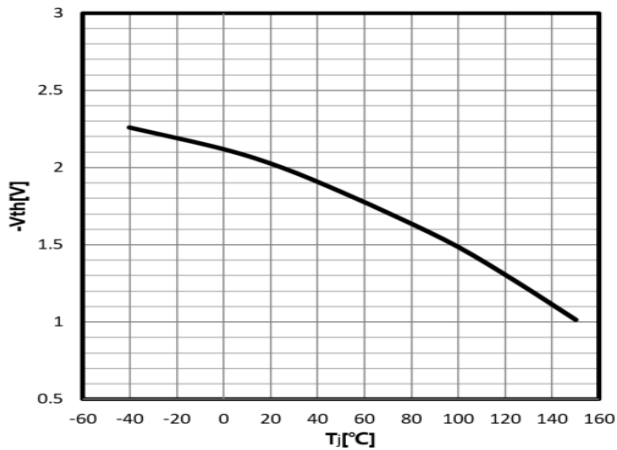
$$-V_{TH} = f(T_j); I_D = -250\mu A$$

Drain-source breakdown voltage

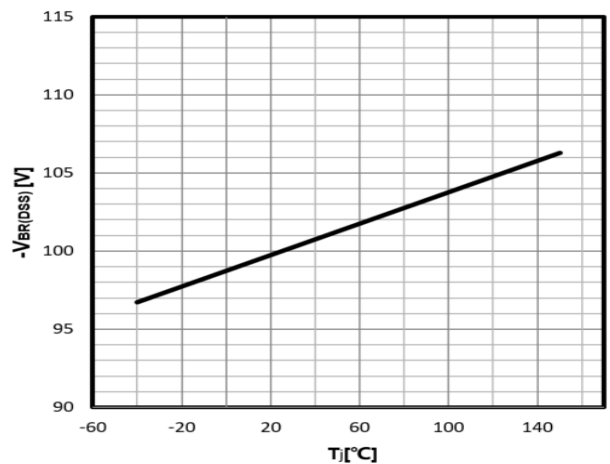
$$-V_{BR(DSS)} = f(T_j); I_D = -250\mu A$$

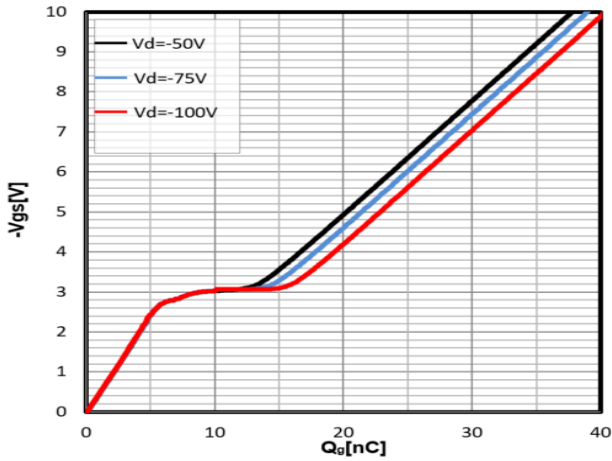
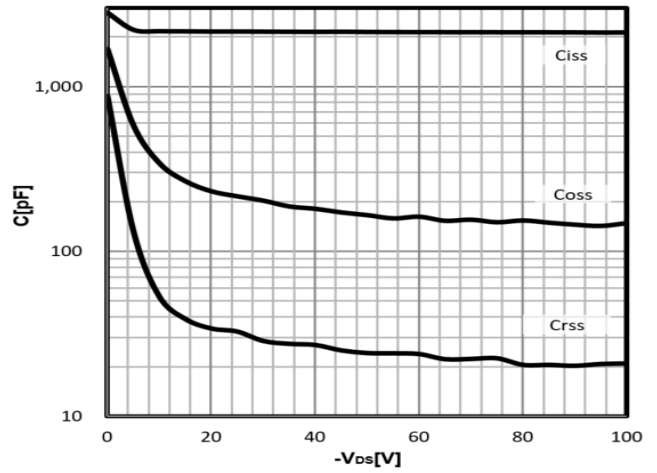
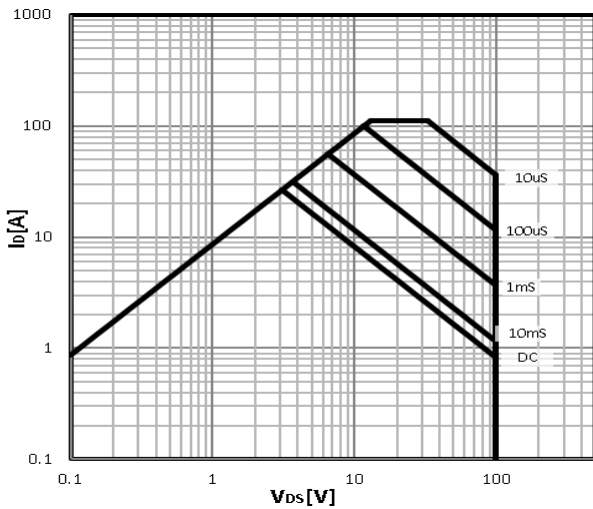
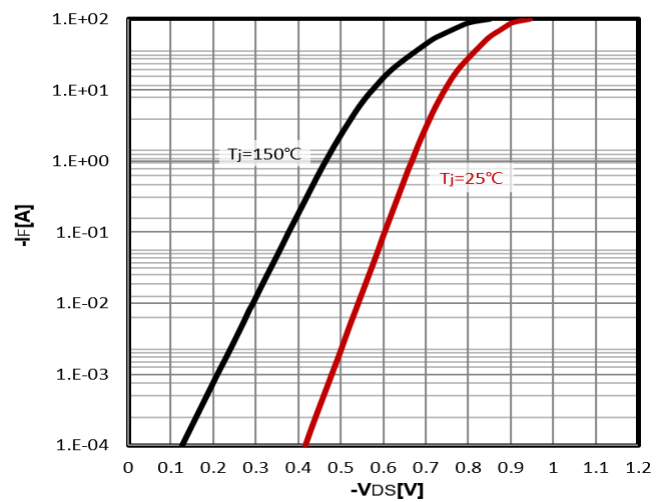
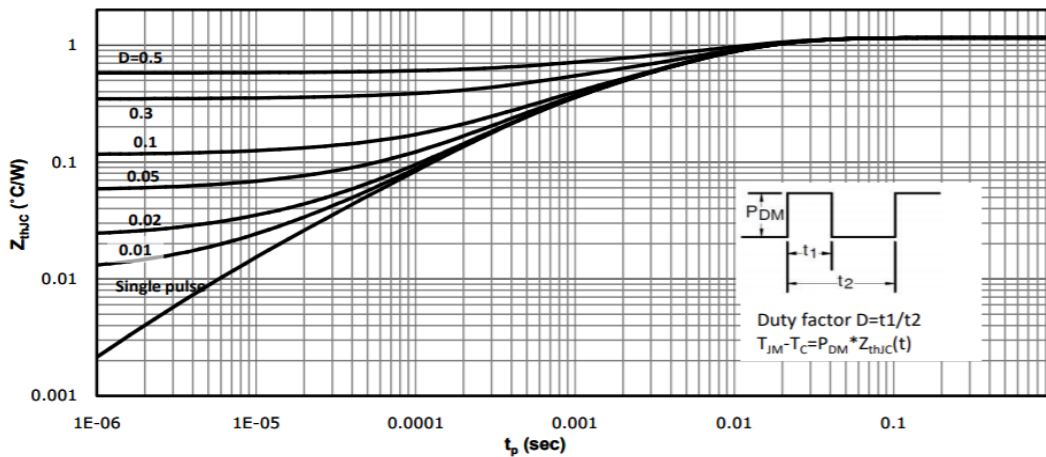

P-Channel Enhancement Mode MOSFET
Typ. gate charge
 $-V_{GS}=f(Q_g)$; $I_D=-20A$

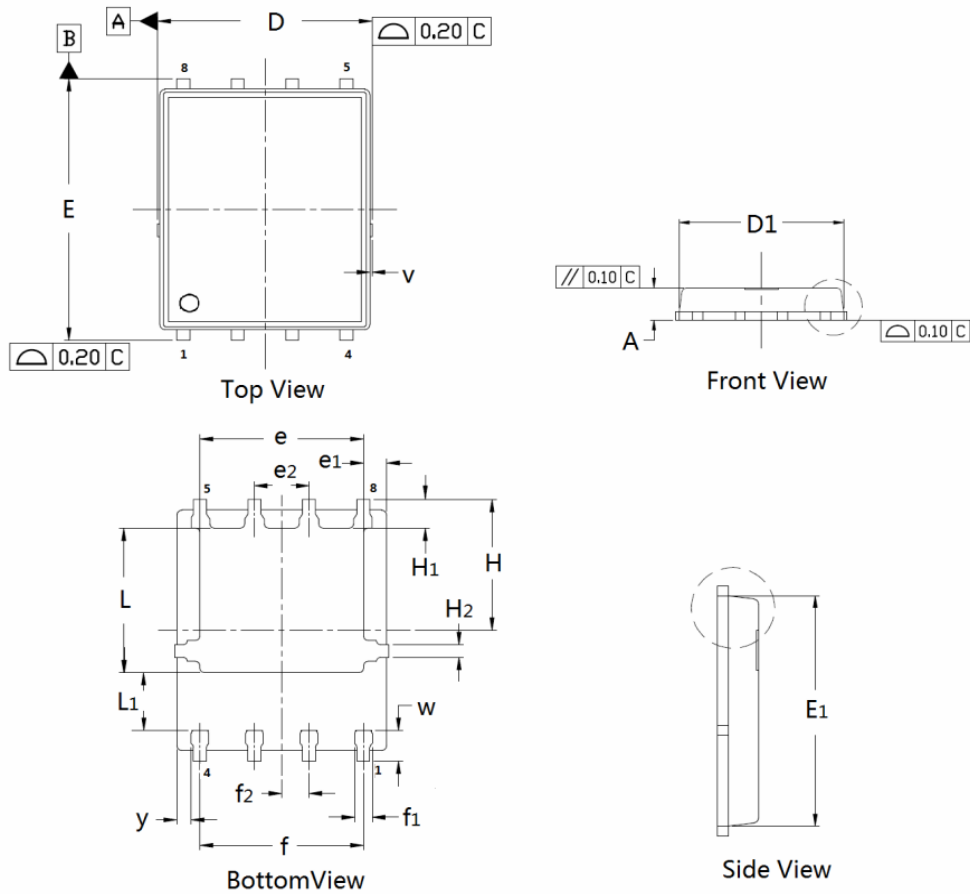
Typ. capacitances
 $C=f(-V_{DS})$; $V_{GS}=0V$; $f=1MHz$

Safe operating area
 $-I_D=f(-V_{DS})$

Body Diode Forward Voltage Variation
 $-I_F=f(-V_{DS})$

Max. transient thermal impedance
 $Z_{thJC}=f(t_p)$

P-Channel Enhancement Mode MOSFET
DFN5×6 Package Outline Data

DIMENSIONS (unit : mm)

Symbol	Min	Typ	Max	Symbol	Min	Typ	Max
A	0.90	1.02	1.10	D	4.90	4.98	5.10
D ₁	4.80	4.89	5.10	E	5.90	6.11	6.25
E ₁	5.65	5.74	5.95	e	3.72	3.80	3.92
e ₁	--	0.5	--	e ₂	--	1.	--
f	--	3.8	--	f ₁	0.31	0.37	0.51
f ₂	--	0.6	--	H	--	3.	--
H ₁	0.59	0.63	0.79	H ₂	0.26	0.28	0.32
L	3.35	3.45	3.65	L ₁	--	1.	--
v	--	0.1	--	w	0.64	0.68	0.84
y	--	0.3	--				