

## N-Channel Enhancement Mode MOSFET

### Features

- Fast switching speed
- Reliable and Rugged
- ROHS Compliant
- 100% UIS and Rg Tested

### Applications

- Power Management in Desktop Computer
- DC/DC Converters

### Pin Description

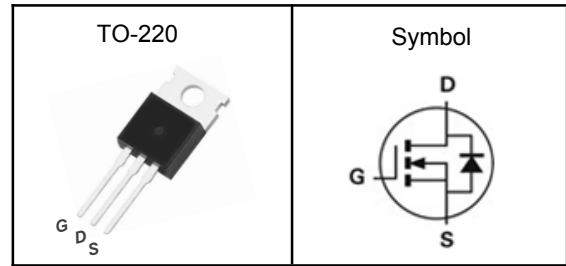

$V_{DSS}$	100	V
$R_{DS(ON)-Typ}$	8.2	m $\Omega$
$I_D$	70	A

### Absolute Maximum Ratings ( $T_C=25^\circ\text{C}$ , Unless Otherwise Noted)

Symbol	Parameter	N-Channel	Unit
$V_{DSS}$	Drain-Source Voltage	100	V
$V_{GSS}$	Gate-Source Voltage	$\pm 20$	V
$T_J$	Maximum Junction Temperature	-55 to 150	$^\circ\text{C}$
$T_{STG}$	Storage Temperature Range	-55 to 150	$^\circ\text{C}$
$E_{AS}$	Single Pulse Avalanche Energy <sup>③</sup>	48	mJ
$I_{DM}^{①}$	Pulse Drain Current Tested	204	A
$I_D$	Continuous Drain Current	$T_C=25^\circ\text{C}$	A
$P_D$	Maximum Power Dissipation	$T_C=25^\circ\text{C}$	W

### Thermal Characteristics

Symbol	Parameter	Rating	Unit
$R_{\theta JA}$	Thermal Resistance-Junction to Ambient	42	$^\circ\text{C}/\text{W}$
$R_{\theta JC}$	Thermal Resistance Junction-Case <sup>①</sup>	0.8	$^\circ\text{C}/\text{W}$

Note ① : Max. current is limited by bonding wire.

Note ② : UIS tested and pulse width are limited by maximum junction temperature  $150^\circ\text{C}$ .

Note ③ : Surface Mounted on  $1\text{in}^2$  FR-4 board with 1oz.

**N-Channel Enhancement Mode MOSFET****Electrical Characteristics** ( $T_J=25^{\circ}\text{C}$ , Unless Otherwise Noted)

Symbol	Parameter	Test Conditions	Min	Typ	Max	Unit
<b>Static Electrical Characteristics</b>						
$BV_{DSS}$	Drain-Source Breakdown Voltage	$V_{GS}=0V, I_D=250\mu A$	100	---	---	V
$I_{DSS}$	Zero Gate Voltage Drain Current	$V_{DS}=80V, V_{GS}=0V$	---	---	1	$\mu A$
$V_{GS(th)}$	Gate Threshold Voltage	$V_{DS}=V_{GS}, I_D=250\mu A$	1.2	---	2.5	V
$I_{GSS}$	Gate Leakage Current	$V_{GS}=\pm 20V, V_{DS}=0V$	---	---	$\pm 100$	nA
$R_{DS(on)}$	Drain-Source On-state Resistance	$V_{GS}=10V, I_D=20A$	---	8.2	10	$m\Omega$
		$V_{GS}=4.5V, I_D=15A$	---	10.8	13	$m\Omega$
<b>Dynamic Characteristics</b> <sup>⑤</sup>						
$C_{iss}$	Input Capacitance	$V_{GS}=0V, V_{DS}=50V, \text{Freq.}=1\text{MHz}$	---	1535	---	pF
$C_{oss}$	Output Capacitance		---	335	---	
$C_{riss}$	Reverse Transfer Capacitance		---	8.2	---	
$T_{d(on)}$	Turn-on Delay Time	$V_{DS}=50V, V_{GS}=10V, R_G=6\Omega, R_L=2.5\Omega,$	---	7.5	---	nS
$T_r$	Turn-on Rise Time		---	15.8	---	
$T_{d(off)}$	Turn-off Delay Time		---	31	---	
$T_f$	Turn-off Fall Time		---	28	---	
$Q_g$	Total Gate Charge	$V_{DS}=50V, V_{GS}=10V, I_D=20A$	---	26	---	nC
$Q_{gs}$	Gate-Source Charge		---	4.3	---	
$Q_{gd}$	Gate-Drain Charge		---	6.8	---	
<b>Source-Drain Characteristics</b> ( $T_J=25^{\circ}\text{C}$ )						
$V_{SD}$ <sup>④</sup>	Diode Forward Voltage	$I_S=1A, V_{GS}=0V$	---	0.7	1.0	V
$t_{rr}$	Reverse Recovery Time	$I_F=20A$	---	50	---	nS
$Q_{rr}$	Reverse Recovery Charge	$di/dt=100A/\mu s, T_J=25^{\circ}\text{C}$	---	79	---	nC

Note ④ : Pulse test (pulse width $\leq 300\mu s$ , duty cycle $\leq 2\%$ ).

Note ⑤ : Guaranteed by design, not subject to production testing.

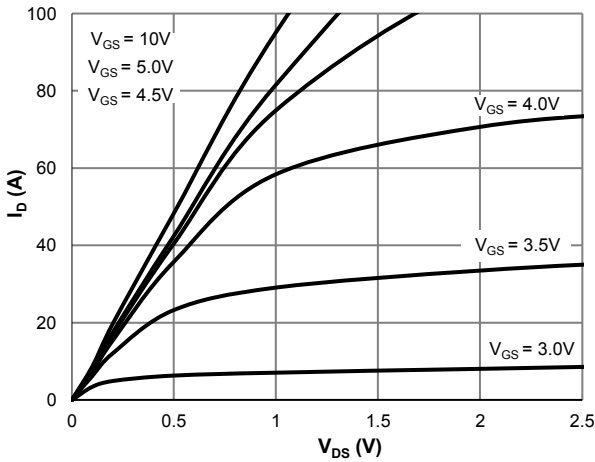
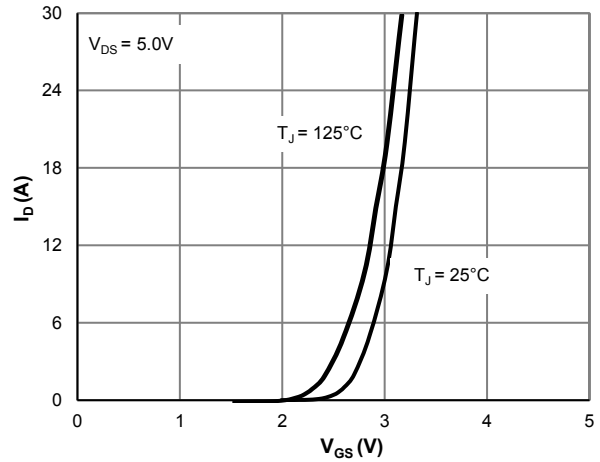
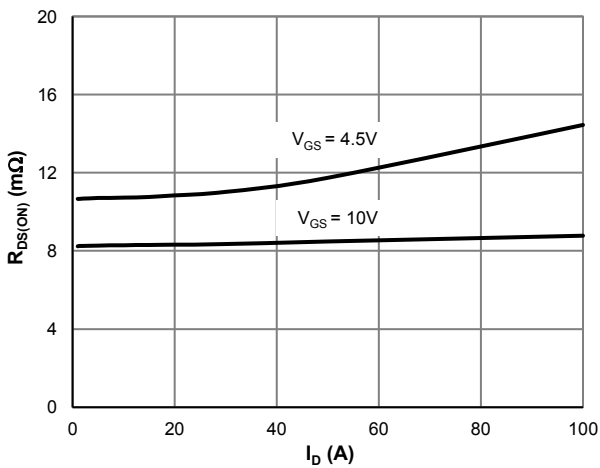
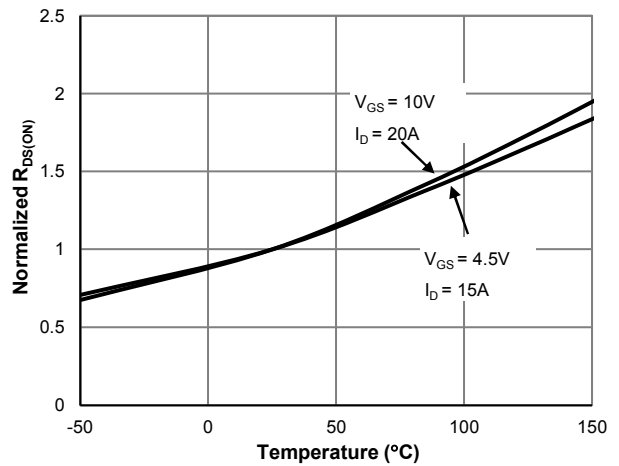
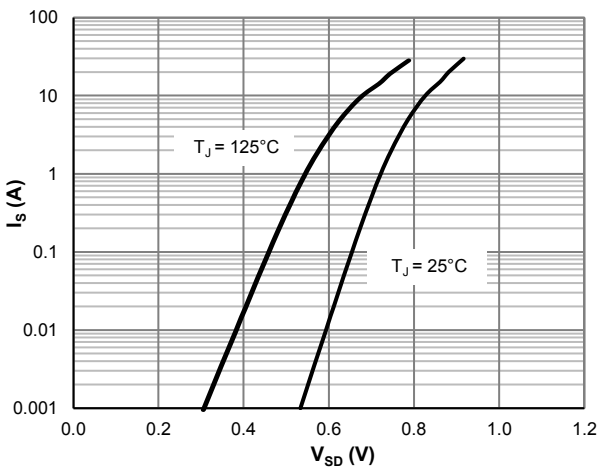
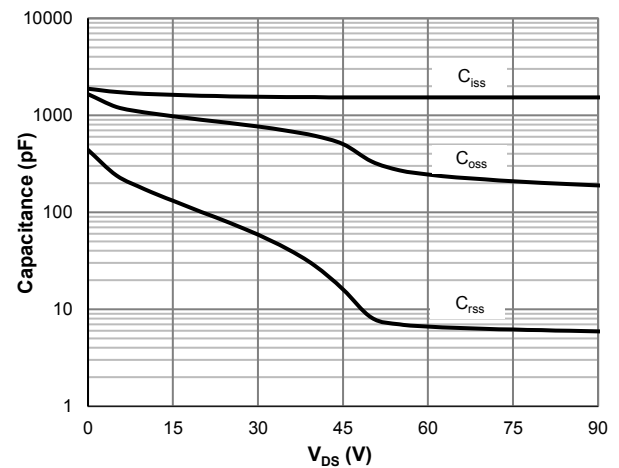
**N-Channel Enhancement Mode MOSFET**
**Typical Characteristics**

**Figure 1: Saturation Characteristics**

**Figure 2: Transfer Characteristics**

**Figure 3:  $R_{DS(ON)}$  vs. Drain Current**

**Figure 4:  $R_{DS(ON)}$  vs. Junction Temperature**

**Figure 5: Body-Diode Characteristics**

**Figure 6: Capacitance Characteristics**

**N-Channel Enhancement Mode MOSFET**

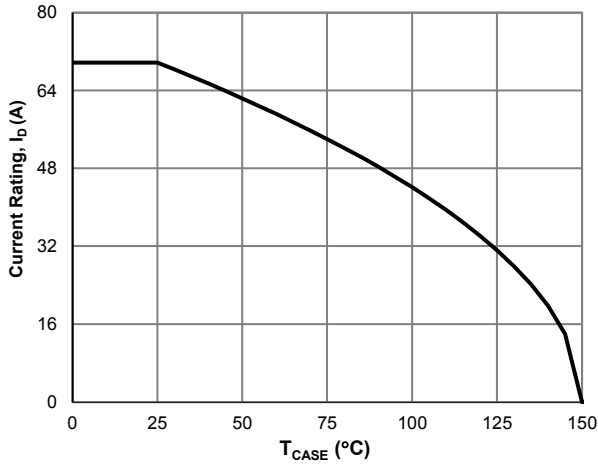

Figure 7: Current De-rating

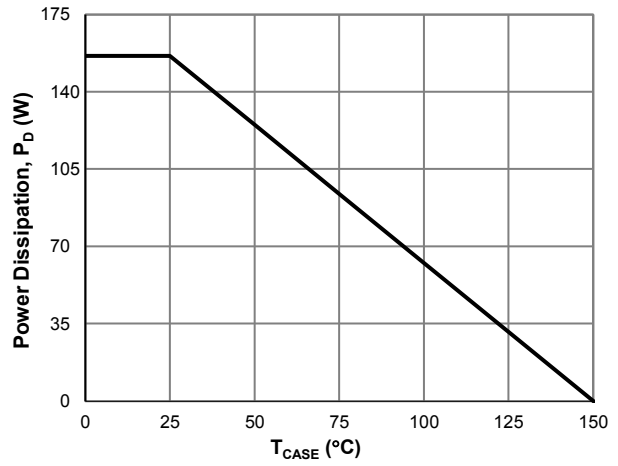

Figure 8: Power De-rating

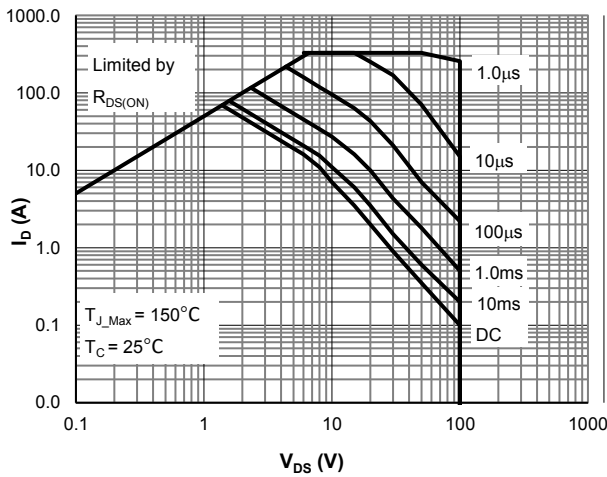

Figure 9: Maximum Safe Operating

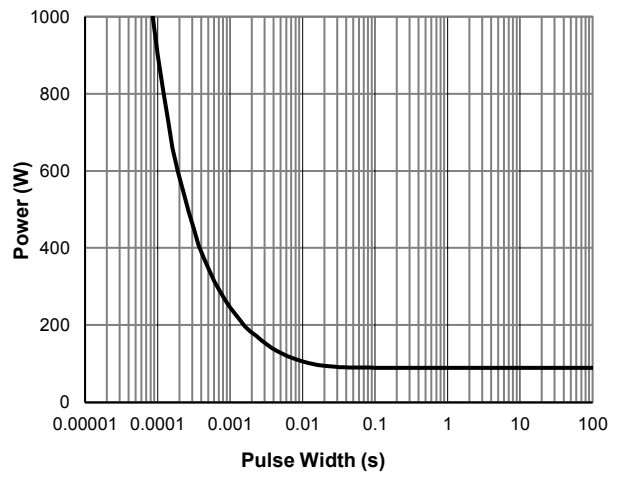

Figure 10: Single Pulse Power Rating, Junction-to-Case

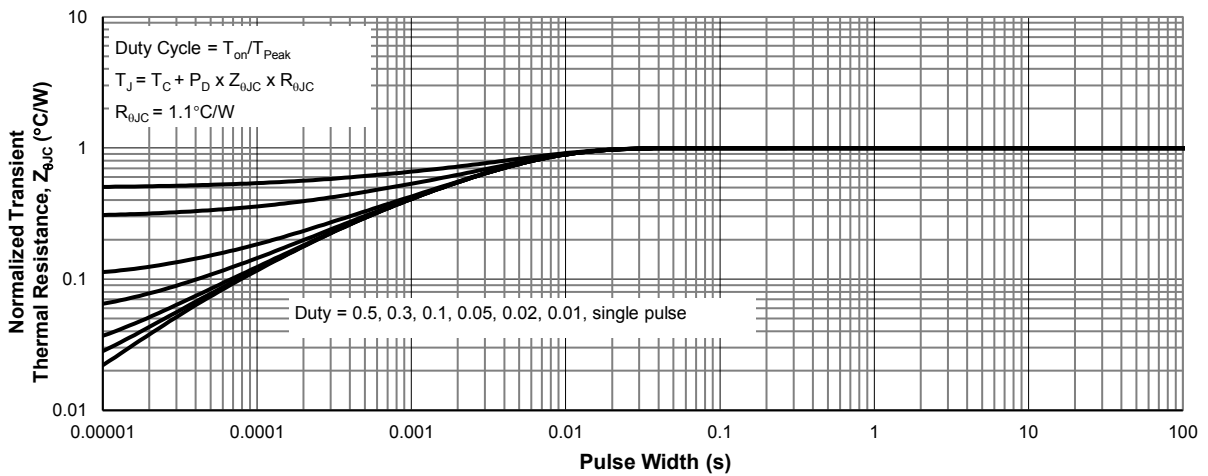
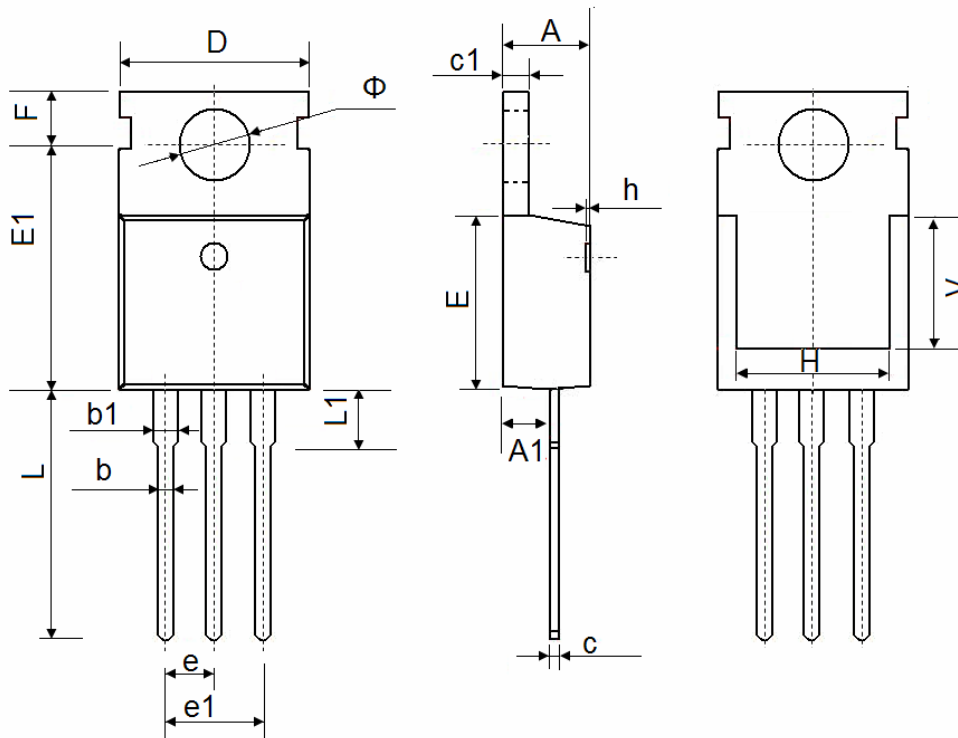

Figure 11: Normalized Maximum Transient Thermal Impedance

**N-Channel Enhancement Mode MOSFET**
**TO-220 Package Outline Data**

Symbol	Dimensions In Millimeters	
	Min.	Max.
A	4.350	4.650
A1	2.250	2.550
b	0.710	0.910
b1	1.170	1.400
c	0.330	0.650
c1	1.200	1.400
D	9.910	10.250
E	8.9500	9.750
E1	12.650	12.950
e	2.540 TYP.	
e1	4.980	5.180
F	2.650	2.950
H	7.900	8.100
h	0.000	0.300
L	12.700	13.500
L1	2.850	3.250
V	7.500 REF.	
Φ	3.400	3.800