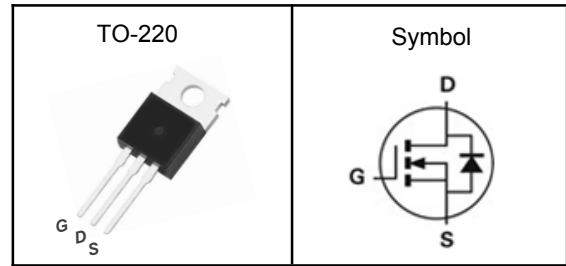

N-Channel Enhancement Mode MOSFET
Features

- Fast switching speed
- Reliable and Rugged
- ROHS Compliant
- 100% UIS and Rg Tested

Applications

- Power Management in Desktop Computer
- DC/DC Converters

Pin Description

V_{DSS}	100	V
$R_{DS(ON)-Typ}$	5.0	m Ω
I_D	102	A

Absolute Maximum Ratings($T_J=25^{\circ}C$, Unless Otherwise Noted)

Symbol	Parameter	N-Channel	Unit
V_{DSS}	Drain-Source Voltage	100	V
V_{GSS}	Gate-Source Voltage	± 20	V
T_J	Maximum Junction Temperature	-55 to 150	$^{\circ}C$
T_{STG}	Storage Temperature Range	-55 to 150	$^{\circ}C$
E_{AS}	Single Pulse Avalanche Energy ³	16	mJ
$I_{DM}^{①}$	Pulse Drain Current Tested	122	A
I_D	Continuous Drain Current	$T_C=25^{\circ}C$	A
P_D	Maximum Power Dissipation	$T_C=25^{\circ}C$	W

Thermal Characteristics

Symbol	Parameter	Rating	Unit
$R_{\theta JA}$	Thermal Resistance-Junction to Ambient	62.5	$^{\circ}C/W$
$R_{\theta JC}$	Thermal Resistance Junction-Case ¹	1	$^{\circ}C/W$

Note ① : Max. current is limited by bonding wire.

Note ② : UIS tested and pulse width are limited by maximum junction temperature 150 $^{\circ}C$.

Note ③ : Surface Mounted on 1in² FR-4 board with 1oz.



N-Channel Enhancement Mode MOSFET

Electrical Characteristics ($T_J=25^\circ\text{C}$, Unless Otherwise Noted)

Symbol	Parameter	Test Conditions	Min	Typ	Max	Unit
Static Electrical Characteristics						
BV_{DSS}	Drain-Source Breakdown Voltage	$V_{GS}=0V, I_D=250\mu A$	100	---	---	V
I_{DSS}	Zero Gate Voltage Drain Current	$V_{DS}=80V, V_{GS}=0V$	---	---	1	μA
$V_{GS(th)}$	Gate Threshold Voltage	$V_{DS}=V_{GS}, I_D=250\mu A$	1	2	3	V
I_{GSS}	Gate Leakage Current	$V_{GS}=\pm 20V, V_{DS}=0V$	---	---	± 100	nA
$R_{DS(on)}$	Drain-Source On-state Resistance	$V_{GS}=10V, I_D=20A$	---	5	6.2	$m\Omega$
		$V_{GS}=4.5V, I_D=20A$	---	7	8	$m\Omega$
Dynamic Characteristics ^⑤						
C_{iss}	Input Capacitance	$V_{GS}=0V, V_{DS}=50V, \text{Freq.}=1\text{MHz}$	---	3010	---	pF
C_{oss}	Output Capacitance		---	540	---	
C_{rss}	Reverse Transfer Capacitance		---	21	---	
$T_{d(on)}$	Turn-on Delay Time	$V_{DD}=50V, V_{GS}=10V, R_G=3\Omega, I_D=1A$	---	11	---	nS
T_r	Turn-on Rise Time		---	21	---	
$T_{d(off)}$	Turn-off Delay Time		---	43	---	
T_f	Turn-off Fall Time		---	26	---	
R_g	Gate Resistance	$V_{DS}=0V, V_{GS}=0V, f=1\text{MHz}$	---	1.8	---	Ω
Q_g	Total Gate Charge	$V_{DS}=50V, V_{GS}=10V, I_D=20A$	---	60	---	nC
Q_{gs}	Gate-Source Charge		---	8.2	---	
Q_{gd}	Gate-Drain Charge		---	16.5	---	
Source-Drain Characteristics ($T_J=25^\circ\text{C}$)						
V_{SD} ^④	Diode Forward Voltage	$I_S=20A, V_{GS}=0V$	---	0.85	1.1	V
t_{rr}	Reverse Recovery Time	$I_F=20A, V_R=50V$	---	55	---	nS
Q_{rr}	Reverse Recovery Charge	$di/dt=100A/\mu s, T_J=25^\circ\text{C}$	---	109	---	nC

Note ④ : Pulse test (pulse width $\leq 300\mu s$, duty cycle $\leq 2\%$).

Note ⑤ : Guaranteed by design, not subject to production testing.

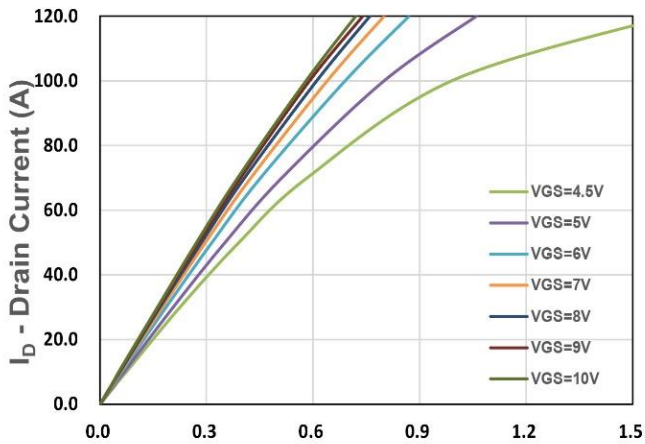
N-Channel Enhancement Mode MOSFET
Typical Characteristics

V_{DS} - Drain - Source Voltage (V)
Figure 1. Output Characteristics

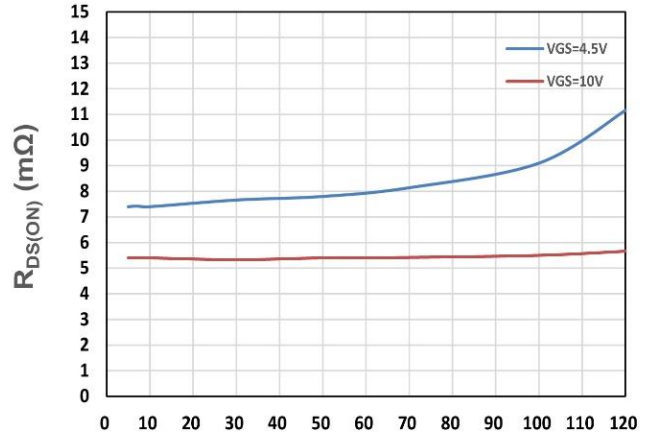

I_D - Drain Current (A)
Figure 2. On-Resistance vs. I_D

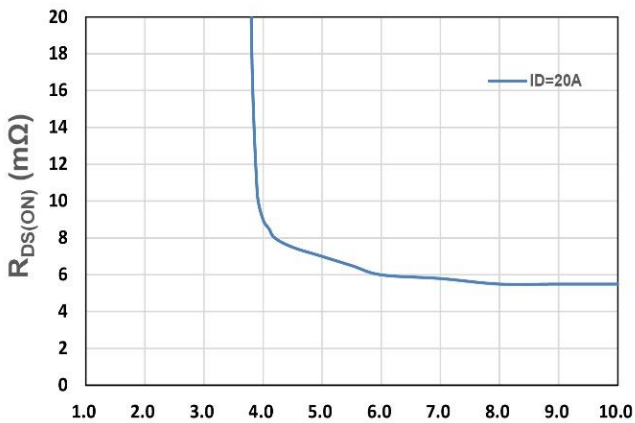

V_{GS} - Gate - Source Voltage (V)
Figure 3. On-Resistance vs. V_{GS}

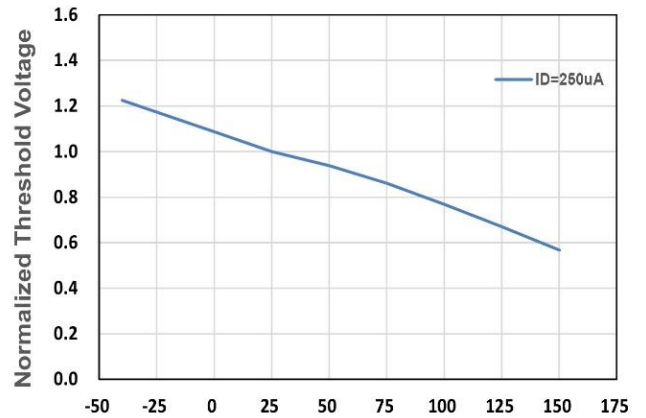

T_j , Junction Temperature($^{\circ}C$)
Figure 4. Gate Threshold Voltage

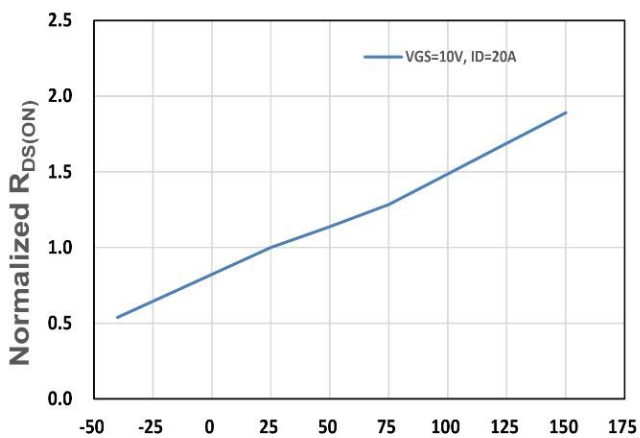

T_j , Junction Temperature($^{\circ}C$)
Figure 5. Drain-Source On Resistance

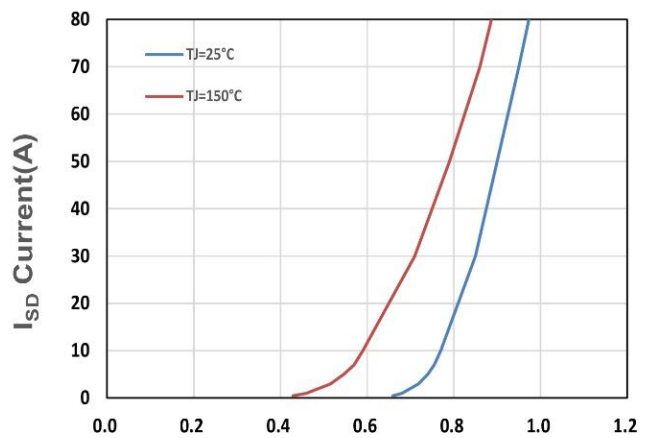

V_{SD} , Source-Drain Voltage(V)
Figure 6. Source-Drain Diode Forward

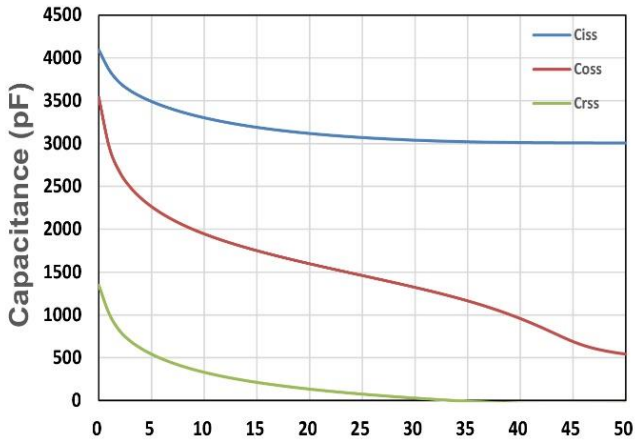
N-Channel Enhancement Mode MOSFET

V_{DS} - Drain - Source Voltage (V)
Figure 7. Capacitance

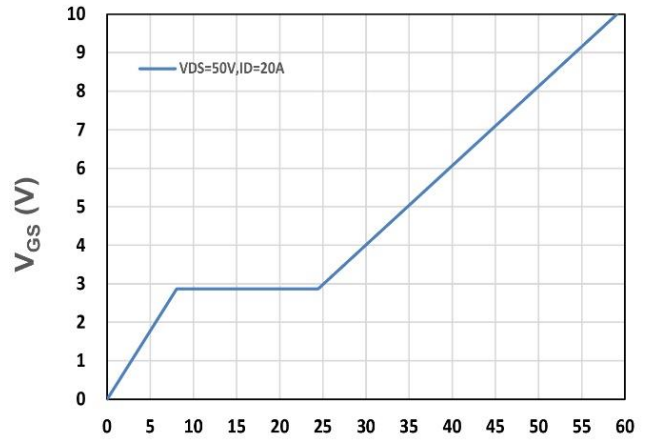

Q_g , Total Gate Charge (nC)
Figure 8. Gate Charge Characteristics

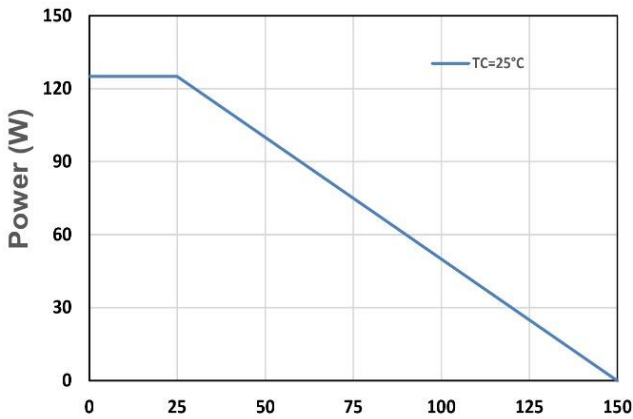

T_j - Junction Temperature (°C)
Figure 9. Power Dissipation

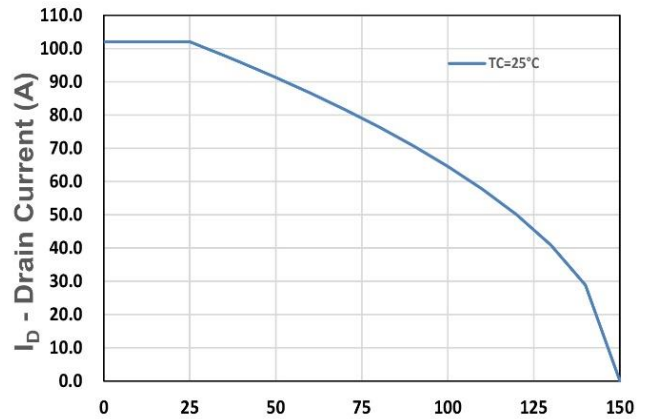

T_j - Junction Temperature (°C)
Figure 10. Drain Current

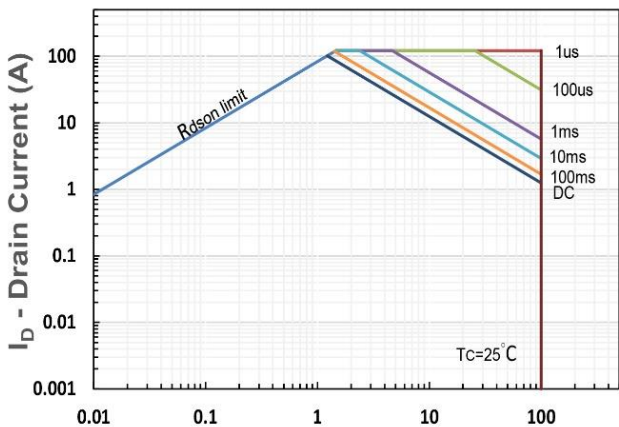

V_{DS} - Drain-Source Voltage (V)
Figure 11. Safe Operating Area

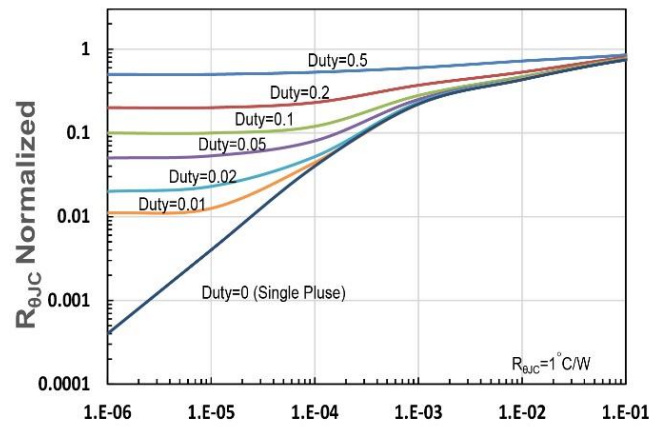

t_1 , Square Wave Pulse Duration (s)
Figure 12. $R_{\theta JC}$ Transient Thermal Impedance

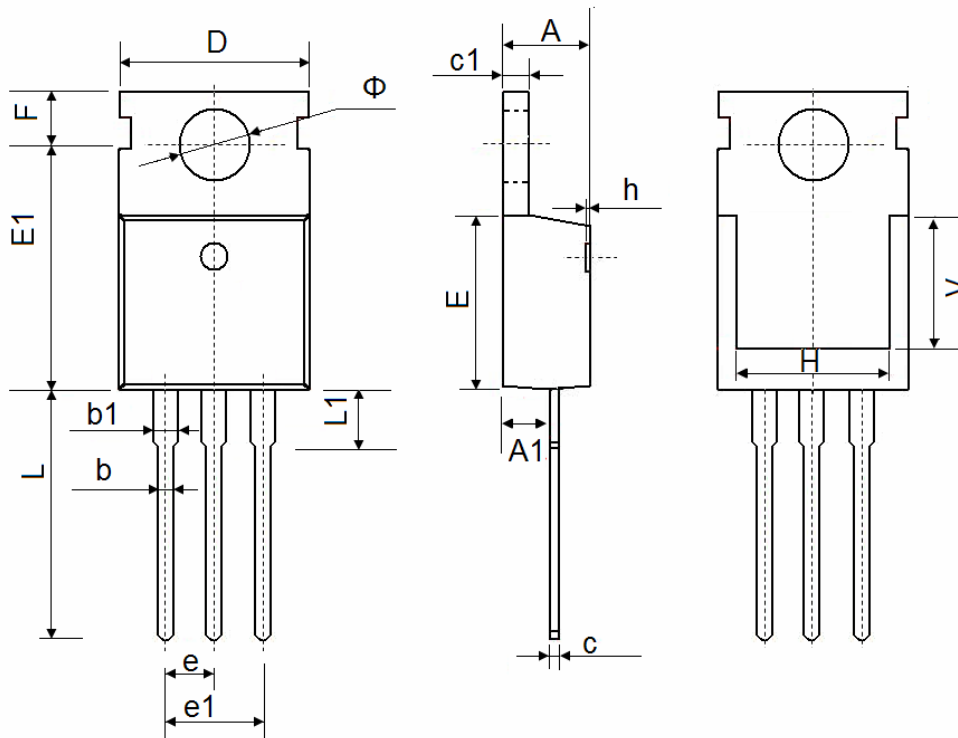
N-Channel Enhancement Mode MOSFET
TO-220 Package Outline Data

Symbol	Dimensions In Millimeters	
	Min.	Max.
A	4.350	4.650
A1	2.250	2.550
b	0.710	0.910
b1	1.170	1.400
c	0.330	0.650
c1	1.200	1.400
D	9.910	10.250
E	8.9500	9.750
E1	12.650	12.950
e	2.540 TYP.	
e1	4.980	5.180
F	2.650	2.950
H	7.900	8.100
h	0.000	0.300
L	12.700	13.500
L1	2.850	3.250
V	7.500 REF.	
Φ	3.400	3.800