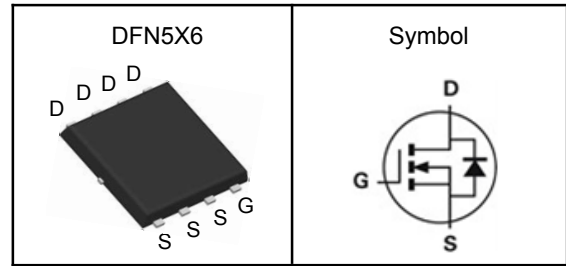

N-Channel Enhancement Mode MOSFET
Features

- Low $R_{ds(on)}$ for low conduction loss
- Reliable and Rugged
- ROHS Compliant & Halogen-Free

Pin Description

Applications

- Power Management in Desktop Computer
- DC/DC Converters

V_{DSS}	100	V
$R_{DS(ON)-Typ}$	4.5	m Ω
I_D	86	A

Absolute Maximum Ratings ($T_A=25^\circ\text{C}$, Unless Otherwise Noted)

Symbol	Parameter	N-Channel	Unit
V_{DSS}	Drain-Source Voltage	100	V
V_{GSS}	Gate-Source Voltage	± 20	V
T_J	Maximum Junction Temperature	-55 to 150	$^\circ\text{C}$
T_{STG}	Storage Temperature Range	-55 to 150	$^\circ\text{C}$
$I_{DM}^{(1)}$	Pulse Drain Current Tested	240	A
I_D	Continuous Drain Current	$T_c=25^\circ\text{C}$	86
		$T_c=100^\circ\text{C}$	55
P_D	Maximum Power Dissipation	$T_c=25^\circ\text{C}$	89
		$T_c=100^\circ\text{C}$	36
$E_{AS}^{(2)}$	Avalanche Energy, Single pulse	76	mJ

Thermal Characteristics

Symbol	Parameter	Rating	Unit
$R_{\theta JA}^{(3)}$	Thermal Resistance-Junction to Ambient	50	$^\circ\text{C}/\text{W}$
$R_{\theta JC}$	Thermal Resistance-Junction to Case	1.4	$^\circ\text{C}/\text{W}$

Note ① : Max. current is limited by bonding wire.

Note ② : UIS tested and pulse width are limited by maximum junction temperature 150°C .

Note ③ : Surface Mounted on 1in^2 FR-4 board with 1oz.



N-Channel Enhancement Mode MOSFET

Electrical Characteristics ($T_J=25^{\circ}\text{C}$, Unless Otherwise Noted)

Symbol	Parameter	Test Conditions	Min	Typ	Max	Unit
Static Electrical Characteristics						
BV_{DSS}	Drain-Source Breakdown Voltage	$V_{GS}=0V, I_D=250\mu A$	100	---	---	V
I_{DSS}	Zero Gate Voltage Drain Current	$V_{DS}=80V, V_{GS}=0V$	---	---	1	μA
$V_{GS(th)}$	Gate Threshold Voltage	$V_{DS}=V_{GS}, I_D=250\mu A$	1	---	3	V
I_{GSS}	Gate Leakage Current	$V_{GS}=\pm 20V, V_{DS}=0V$	---	---	± 100	nA
$R_{DS(on)}$	Drain-Source On-state Resistance	$V_{GS}=10V, I_D=20A$	---	4.5	6	m Ω
		$V_{GS}=4.5V, I_D=20A$	---	6.6	8.6	
Dynamic Characteristics^⑤						
C_{iss}	Input Capacitance	$V_{GS}=0V, V_{DS}=50V, \text{Freq.}=1\text{MHz}$	---	3005	---	pF
C_{oss}	Output Capacitance		---	540	---	
C_{rss}	Reverse Transfer Capacitance		---	20	---	
$T_{d(on)}$	Turn-on Delay Time	$V_{DD}=50V, V_{GS}=10V, R_G=3\Omega, I_D=1A$	---	11	---	nS
T_r	Turn-on Rise Time		---	20	---	
$T_{d(off)}$	Turn-off Delay Time		---	42	---	
T_f	Turn-off Fall Time		---	25	---	
Q_g	Total Gate Charge	$V_{DS}=50V, V_{GS}=10V, I_D=20A$	---	59	---	nC
Q_{gs}	Gate-Source Charge		---	8.1	---	
Q_{gd}	Gate-Drain Charge		---	16.4	---	
Source-Drain Characteristics						
$V_{SD}^{④}$	Diode Forward Voltage	$I_S=20A, V_{GS}=0V$	---	0.8	1.1	V
T_{rr}	Reverse Recovery Time	$I_S=20A, di_F/dt=100A/\mu s$	---	53	---	nS
Q_{rr}	Reverse Recovery Charge		---	102	---	nC

Note ④ : Pulse test (pulse width $\leq 300\mu s$, duty cycle $\leq 2\%$).

Note ⑤ : Guaranteed by design, not subject to production testing.

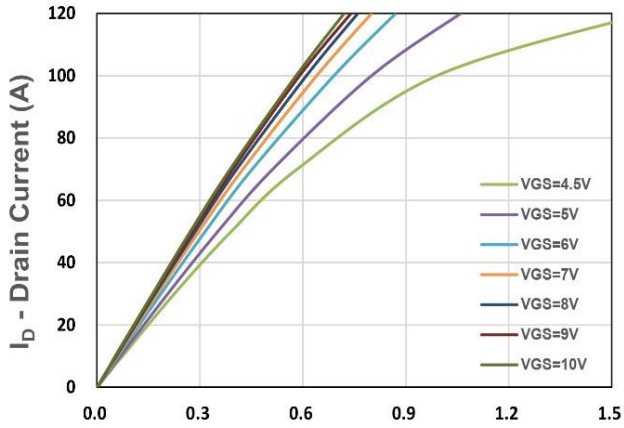
N-Channel Enhancement Mode MOSFET
Typical Characteristics

V_{DS} - Drain - Source Voltage (V)
Figure 1. Output Characteristics

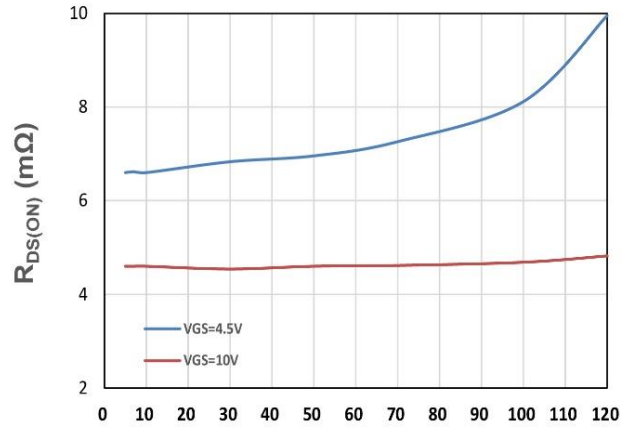

I_D - Drain Current (A)
Figure 2. On-Resistance vs. I_D

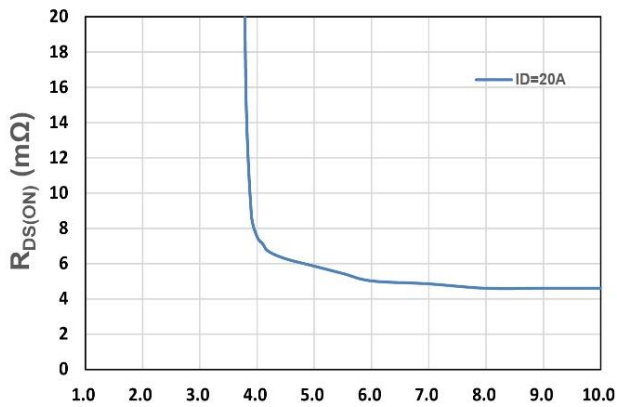

V_{GS} - Gate - Source Voltage (V)
Figure 3. On-Resistance vs. V_{GS}

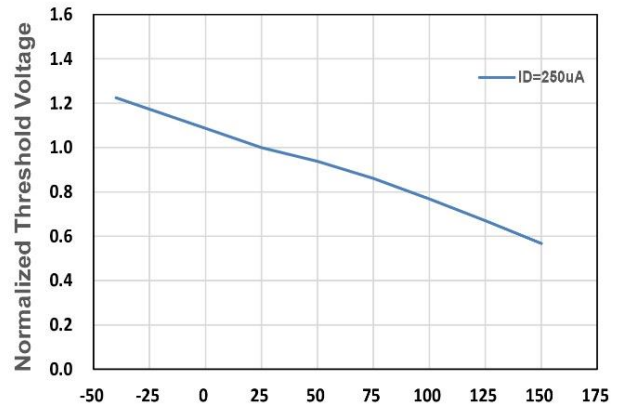

T_j , Junction Temperature ($^{\circ}C$)
Figure 4. Gate Threshold Voltage

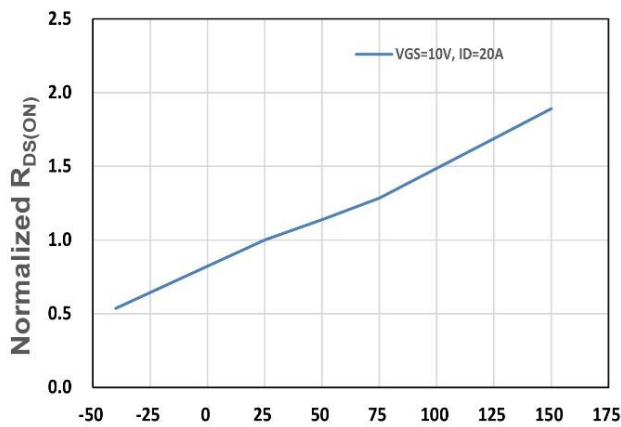

T_j , Junction Temperature ($^{\circ}C$)
Figure 5. Drain-Source On Resistance

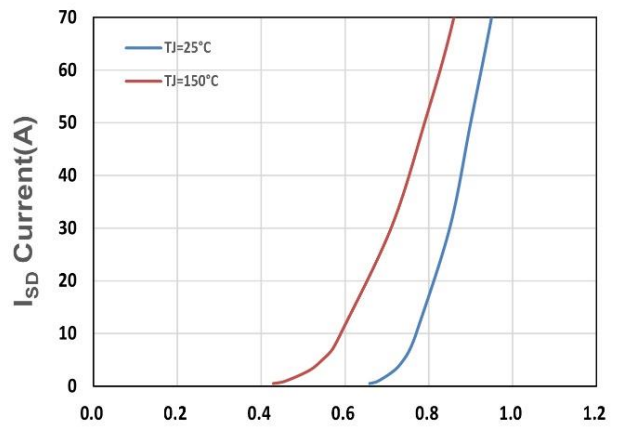

V_{SD} , Source-Drain Voltage (V)
Figure 6. Source-Drain Diode Forward

N-Channel Enhancement Mode MOSFET

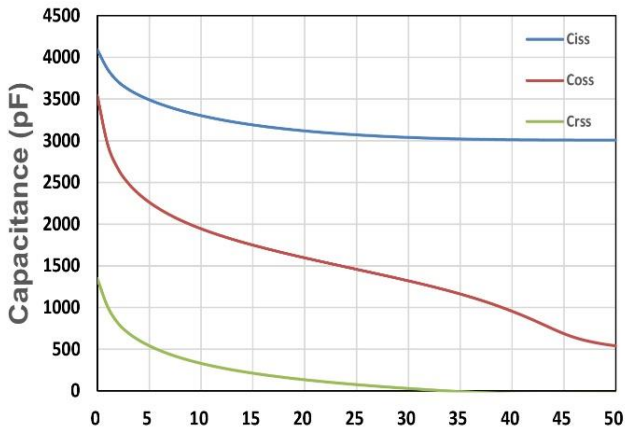

V_{DS} - Drain - Source Voltage (V)
Figure 7. Capacitance

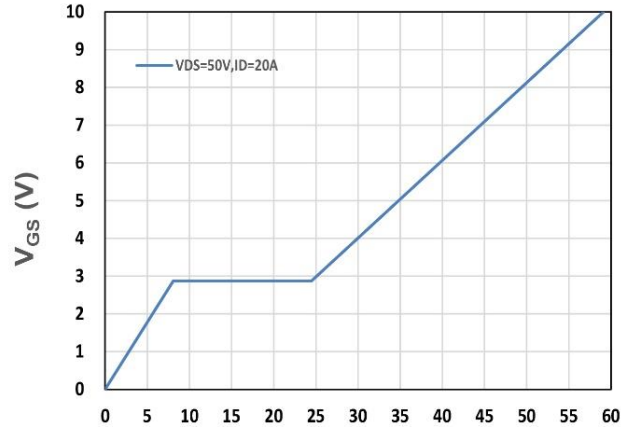

Q_g , Total Gate Charge (nC)
Figure 8. Gate Charge Characteristics

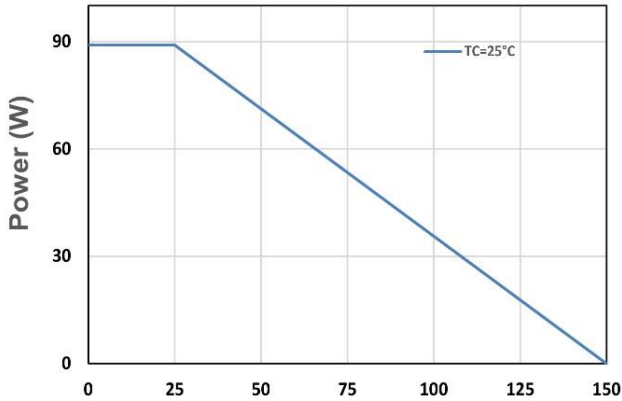

T_j - Junction Temperature (°C)
Figure 9. Power Dissipation

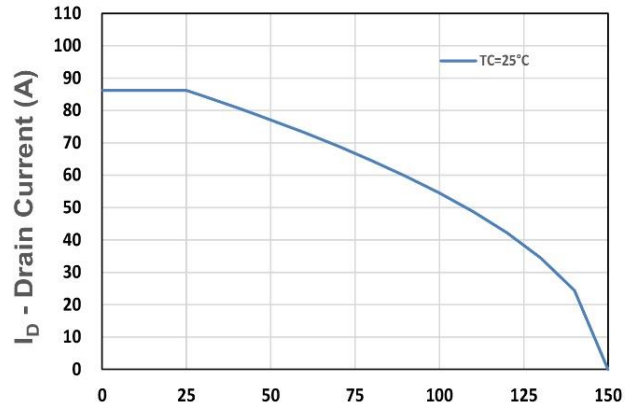

T_j - Junction Temperature (°C)
Figure 10. Drain Current

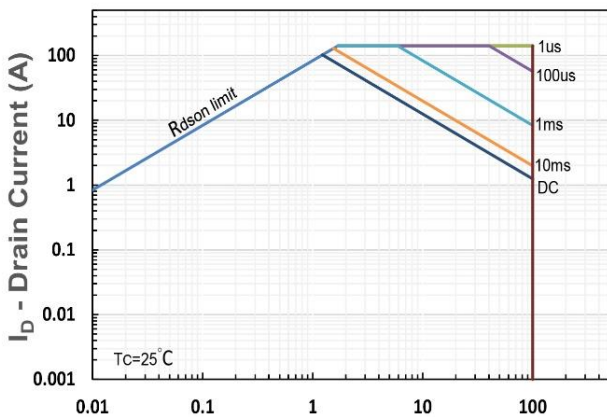

V_{DS} - Drain-Source Voltage (V)
Figure 11. Safe Operating Area

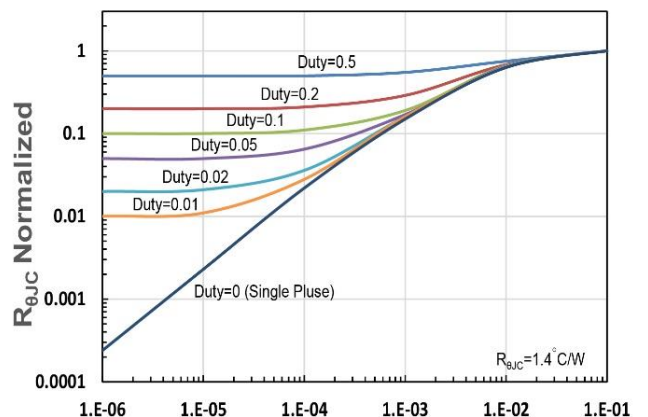

t_1 , Square Wave Pulse Duration(s)
Figure 12. $R_{\theta JC}$ Transient Thermal Impedance

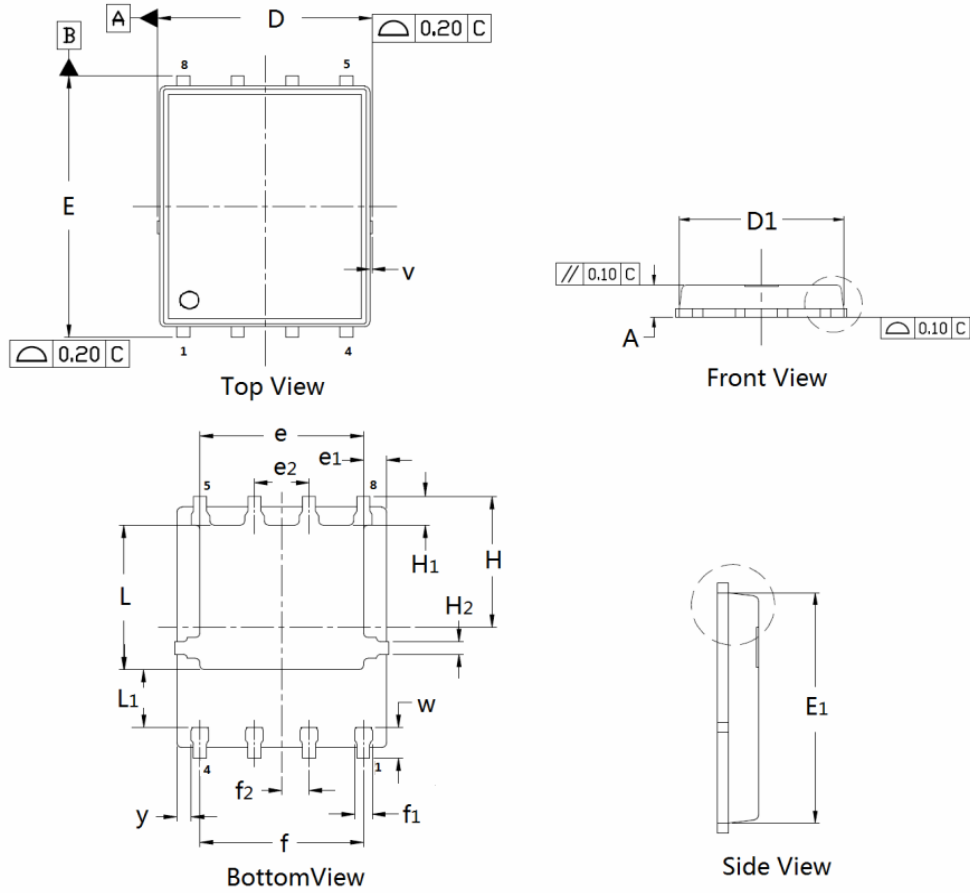
N-Channel Enhancement Mode MOSFET
DFN5×6 Package Outline Data

DIMENSIONS (unit : mm)

Symbol	Min	Typ	Max	Symbol	Min	Typ	Max
A	0.90	1.02	1.10	D	4.90	4.98	5.10
D ₁	4.80	4.89	5.10	E	5.90	6.11	6.25
E ₁	5.65	5.74	5.95	e	3.72	3.80	3.92
e ₁	--	0.5	--	e ₂	--	1.	--
f	--	3.8	--	f ₁	0.31	0.37	0.51
f ₂	--	0.6	--	H	--	3.	--
H ₁	0.59	0.63	0.79	H ₂	0.26	0.28	0.32
L	3.35	3.45	3.65	L ₁	--	1.	--
v	--	0.1	--	w	0.64	0.68	0.84
y	--	0.3	--				