

P-Channel Enhancement Mode MOSFET

Features

- Low $R_{ds(on)}$ for low conduction loss
- Reliable and Rugged
- ROHS Compliant & Halogen-Free

Applications

- Power Management in Desktop Computer
- DC/DC Converters

Pin Description

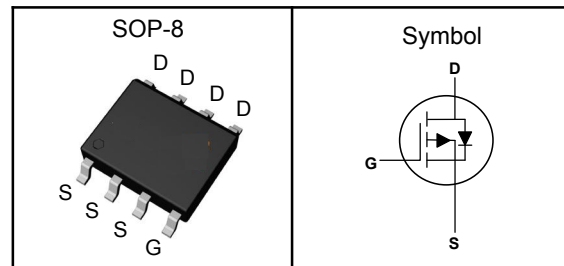

V_{DSS}	-60	V
$R_{DS(ON)-Typ}$	70	m Ω
I_D	-4.1	A

Absolute Maximum Ratings ($T_A=25^{\circ}C$, Unless Otherwise Noted)

Symbol	Parameter	P-Channel	Unit
V_{DSS}	Drain-Source Voltage	-60	V
V_{GSS}	Gate-Source Voltage	± 20	V
T_J	Maximum Junction Temperature	-55 to 150	$^{\circ}C$
T_{STG}	Storage Temperature Range	-55 to 150	$^{\circ}C$
$I_{DM}^{①}$	Pulse Drain Current Tested	-8.2	A
I_D	Continuous Drain Current	-4.1	A
P_D	Maximum Power Dissipation	3.1	W
E_{AS}	Single Pulse Avalanche Energy ³	29.7	mJ
I_{AS}	Avalanche Current	-24.4	A

Thermal Characteristics

Symbol	Parameter	Rating	Unit
$R_{\theta JA}^{②}$	Thermal Resistance-Junction to Ambient	85	$^{\circ}C/W$
$R_{\theta JC}$	Thermal Resistance Junction-Case	36	$^{\circ}C/W$

Note ① : Max. current is limited by bonding wire.

Note ② : UIS tested and pulse width are limited by maximum junction temperature 150 $^{\circ}C$.

Note ③ : Surface Mounted on 1in² FR-4 board with 1oz.



P-Channel Enhancement Mode MOSFET

Electrical Characteristics ($T_J=25^{\circ}\text{C}$, Unless Otherwise Noted)

Symbol	Parameter	Test Conditions	Min	Typ	Max	Unit
Static Electrical Characteristics						
BV_{DSS}	Drain-Source Breakdown Voltage	$V_{GS}=0V, I_D=-250\mu A$	-60	---	---	V
I_{DSS}	Zero Gate Voltage Drain Current	$V_{DS}=-48V, V_{GS}=0V$	---	---	-1	μA
$V_{GS(th)}$	Gate Threshold Voltage	$V_{DS}=V_{GS}, I_D=-250\mu A$	-1.0	---	-2.5	V
I_{GSS}	Gate Leakage Current	$V_{GS}=\pm 20V, V_{DS}=0V$	---	---	± 100	nA
$R_{DS(on)}$	Drain-Source On-state Resistance	$V_{GS}=-10V, I_D=-3A$	---	70	90	$m\Omega$
		$V_{GS}=-4.5V, I_D=-2A$	---	90	115	$m\Omega$
R_g	Gate Resistance	$V_{DS}=0V, V_{GS}=0V, f=1MHz$	---	15	---	Ω
Dynamic Characteristics ^⑤						
C_{iss}	Input Capacitance	$V_{GS}=0V, V_{DS}=-15V, \text{Freq.}=1MHz$	---	1080	---	pF
C_{oss}	Output Capacitance		---	73	---	
C_{rss}	Reverse Transfer Capacitance		---	50	---	
$T_{d(on)}$	Turn-on Delay Time	$V_{DD}=-15V, V_{GS}=-10V, R_G=3.3\Omega, I_D=-1A$	---	8.8	---	nS
T_r	Turn-on Rise Time		---	19.6	---	
$T_{d(off)}$	Turn-off Delay Time		---	47.8	---	
T_f	Turn-off Fall Time		---	6.9	---	
Q_g	Total Gate Charge	$V_{DS}=-48V, V_{GS}=-4.5V, I_D=-3A$	---	11.8	---	nC
Q_{gs}	Gate-Source Charge		---	1.9	---	
Q_{gd}	Gate-Drain Charge		---	6.5	---	
Source-Drain Characteristics ($T_J=25^{\circ}\text{C}$)						
V_{SD} ^④	Diode Forward Voltage	$V_{GS}=0V, I_S=-1A, T_J=25^{\circ}\text{C}$	---	---	-1.2	V

Note ④ : Pulse test (pulse width $\leq 300\mu s$, duty cycle $\leq 2\%$).

Note ⑤ : Guaranteed by design, not subject to production testing.

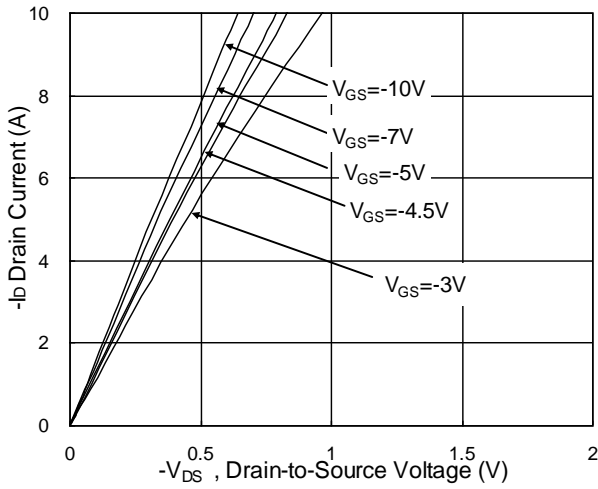
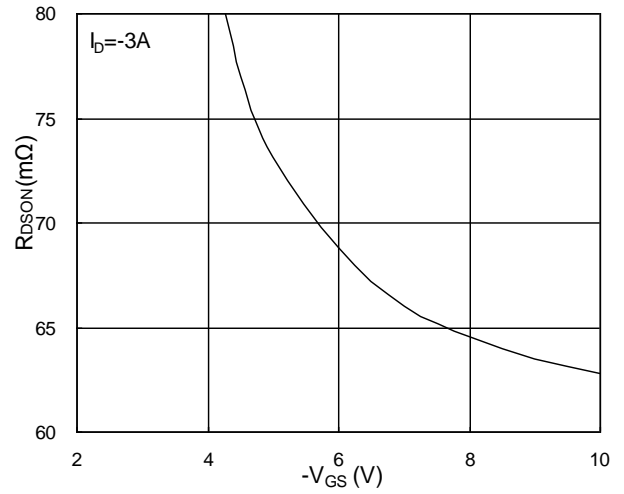
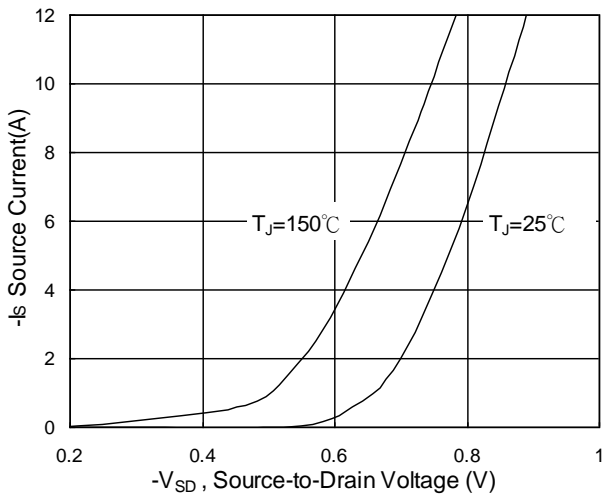
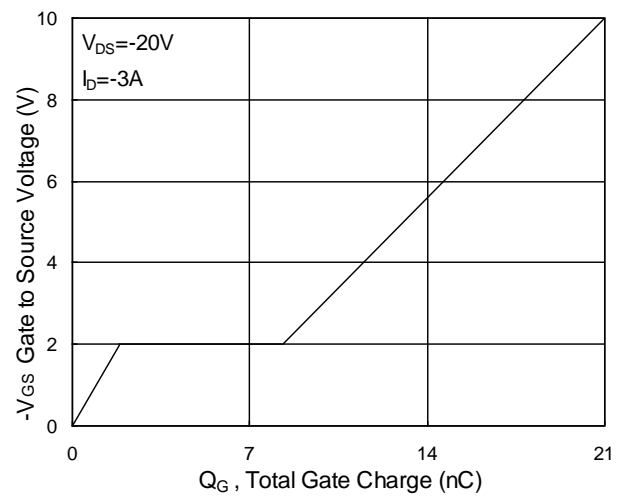
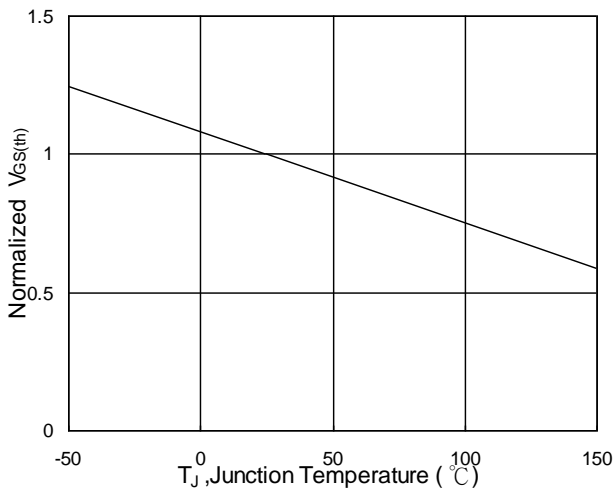
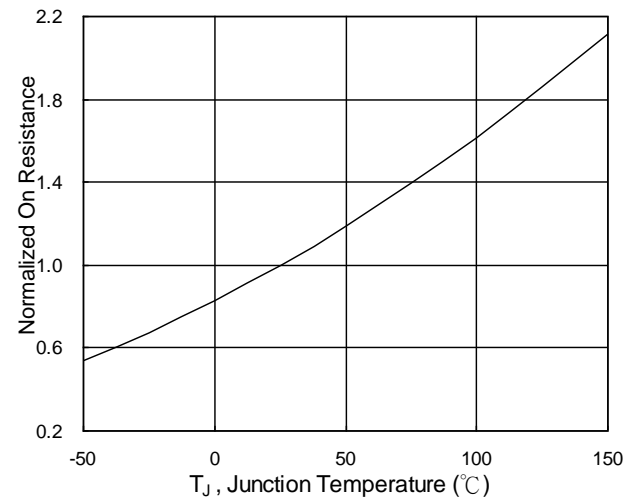
P-Channel Enhancement Mode MOSFET
Typical Characteristics

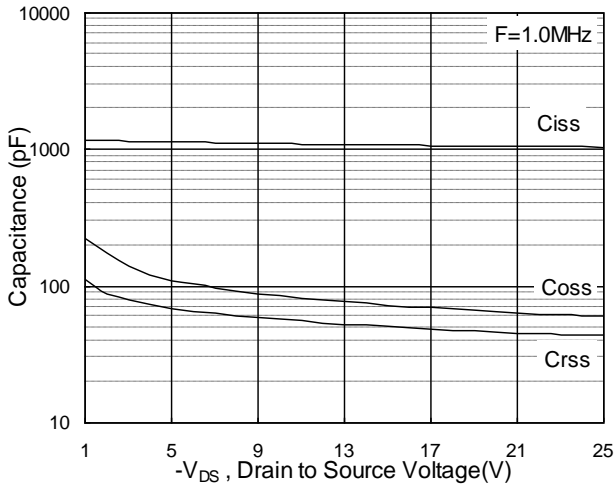
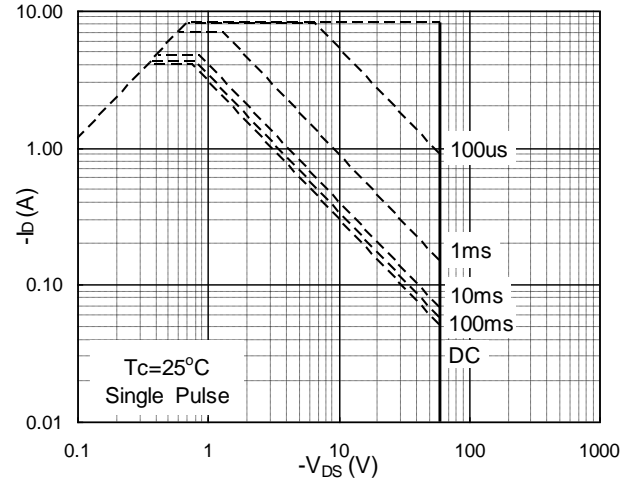
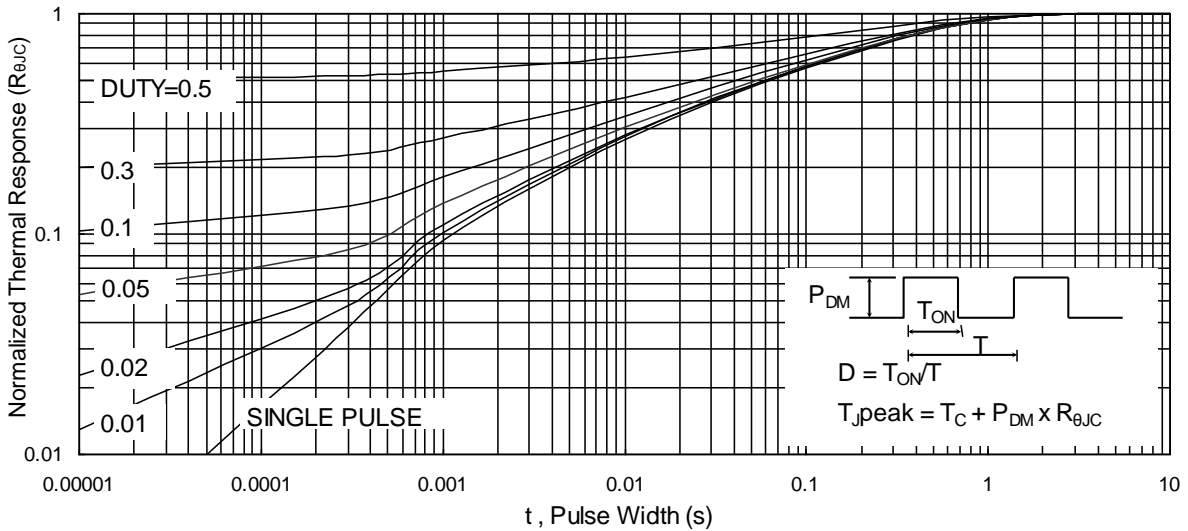
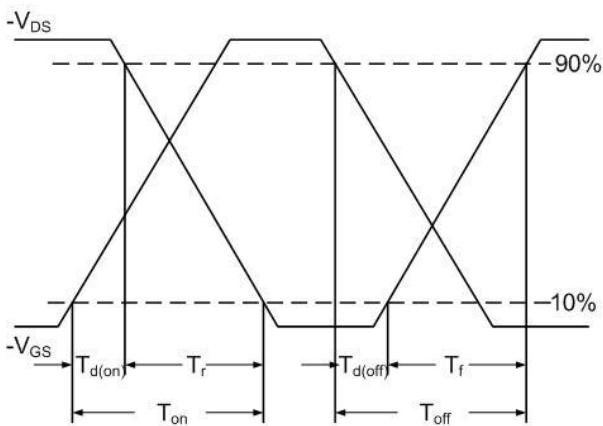
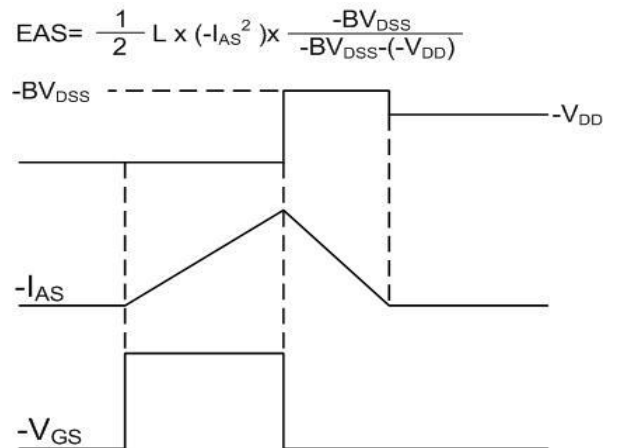
Fig.1 Typical Output Characteristics

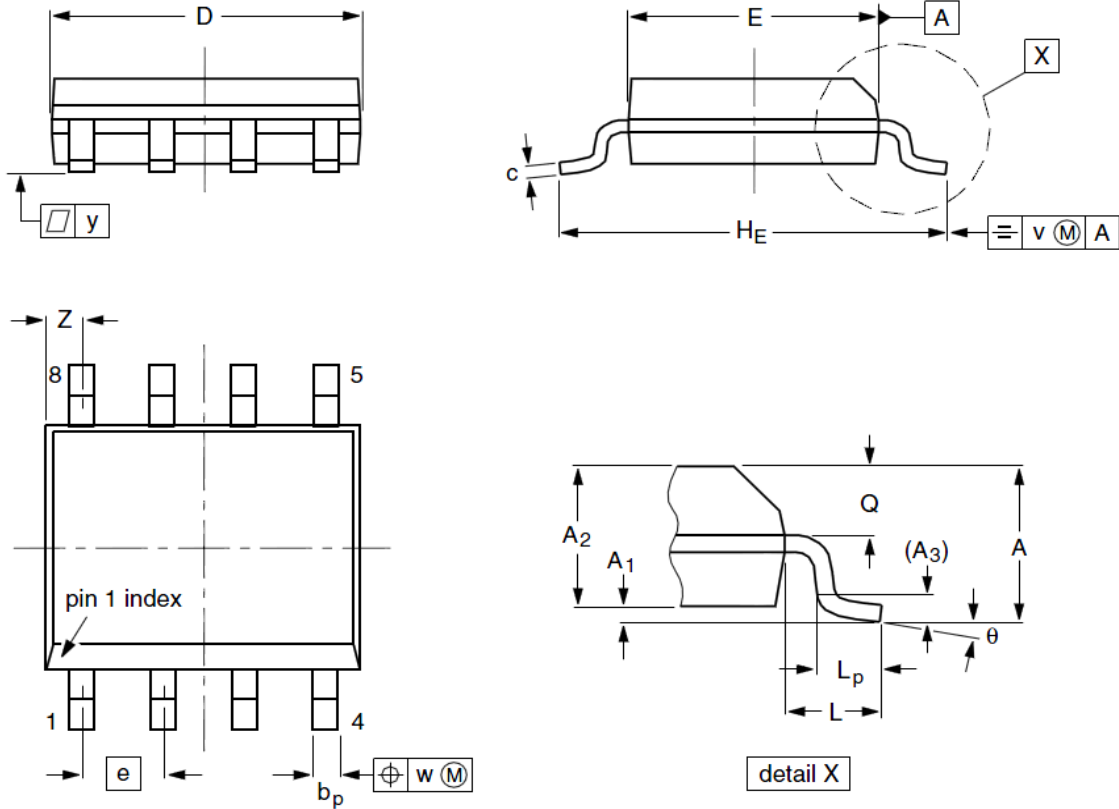
Fig.2 On-Resistance v.s Gate-Source

Fig.3 Forward Characteristics of Reverse

Fig.4 Gate-Charge Characteristics

Fig.5 Normalized $V_{GS(th)}$ vs. T_J

Fig.6 Normalized $R_{DS(on)}$ vs. T_J

P-Channel Enhancement Mode MOSFET

Fig.7 Capacitance

Fig.8 Safe Operating Area

Fig.9 Normalized Maximum Transient Thermal Impedance

Fig.10 Switching Time Waveform

Fig.11 Unclamped Inductive Waveform

P-Channel Enhancement Mode MOSFET
SOP-8 Package Outline Dimensions

Symbol	Dimensions (unit:mm)			Symbol	Dimensions (unit:mm)		
	Min	Typ	Max		Min	Typ	Max
A	1.35	1.55	1.75	A₁	0.10	0.18	0.25
A₂	1.25	1.45	1.65	A₃	--	0.25	--
b_p	0.36	0.42	0.51	c	0.19	0.22	0.25
D	4.70	4.92	5.10	E	3.80	3.90	4.00
e	--	1.27	--	H_E	5.80	6.00	6.20
L	--	1.05	--	L_p	0.40	0.68	1.00
Q	0.60	0.65	0.73	v	--	0.25	--
w	--	0.25	--	y	--	0.10	--
Z	0.30	0.50	0.70	θ	0°		8°