

N-Channel Enhancement Mode MOSFET

Features

- Fast switching speed
- Reliable and Rugged
- ROHS Compliant
- 100% UIS and Rg Tested

Applications

- Power Management in Desktop Computer
- DC/DC Converters

Pin Description

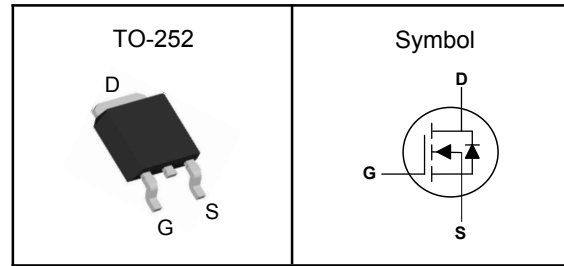

V_{DSS}	60	V
$R_{DS(ON)-Typ}$	33	m Ω
I_D	20	A

Absolute Maximum Ratings ($T_J=25^\circ\text{C}$, Unless Otherwise Noted)

Symbol	Parameter	N-Channel	Unit
V_{DSS}	Drain-Source Voltage	100	V
V_{GSS}	Gate-Source Voltage	± 20	V
T_J	Maximum Junction Temperature	-55 to 150	$^\circ\text{C}$
T_{STG}	Storage Temperature Range	-55 to 150	$^\circ\text{C}$
E_{AS}	Single Pulse Avalanche Energy ³	22	mJ
$I_{DM}^{①}$	300 μs Pulse Drain Current Tested	40	A
I_D	Continuous Drain Current	$T_c=25^\circ\text{C}$	A
P_D	Maximum Power Dissipation	$T_c=25^\circ\text{C}$	W

Thermal Characteristics

Symbol	Parameter	Rating	Unit
$R_{\theta JA}$	Thermal Resistance Junction-Ambient ¹ (Max)	62	$^\circ\text{C}/\text{W}$
$R_{\theta JC}$	Thermal Resistance Junction-Case ¹	4	$^\circ\text{C}/\text{W}$

Note ① : Max. current is limited by bonding wire.

Note ② : UIS tested and pulse width are limited by maximum junction temperature 150 $^\circ\text{C}$.

Note ③ : Surface Mounted on 1in² FR-4 board with 1oz.



N-Channel Enhancement Mode MOSFET

Electrical Characteristics ($T_J=25^{\circ}\text{C}$, Unless Otherwise Noted)

Symbol	Parameter	Test Conditions	Min	Typ	Max	Unit
Static Electrical Characteristics						
BV_{DSS}	Drain-Source Breakdown Voltage	$V_{GS}=0V, I_D=250mA$	60	---	---	V
I_{DSS}	Zero Gate Voltage Drain Current	$V_{DS}=48V, V_{GS}=0V$	---	---	1	μA
$V_{GS(th)}$	Gate Threshold Voltage	$V_{DS}=V_{GS}, I_D=250\mu A$	1.0	---	2.5	V
I_{GSS}	Gate Leakage Current	$V_{GS}=\pm 20V, V_{DS}=0V$	---	---	± 100	nA
$R_{DS(on)}$	Drain-Source On-state Resistance	$V_{GS}=10V, I_D=15A$	---	33	40	$m\Omega$
		$V_{GS}=4.5V, I_D=7A$	---	40	50	$m\Omega$
Dynamic Characteristics ^⑤						
C_{iss}	Input Capacitance	$V_{GS}=0V, V_{DS}=15V, \text{Freq.}=1MHz$	---	1027	---	pF
C_{oss}	Output Capacitance		---	65	---	
C_{rss}	Reverse Transfer Capacitance		---	46	---	
$T_{d(on)}$	Turn-on Delay Time	$V_{DD}=30V, V_{GS}=10V, R_G=3.3\Omega, I_D=15A$	---	2.8	---	nS
T_r	Turn-on Rise Time		---	16.6	---	
$T_{d(off)}$	Turn-off Delay Time		---	21.2	---	
T_f	Turn-off Fall Time		---	5.6	---	
Q_g	Total Gate Charge	$V_{DS}=48V, V_{GS}=10V, I_D=15A$	---	19	---	nC
Q_{gs}	Gate-Source Charge		---	2.5	---	
Q_{gd}	Gate-Drain Charge		---	5	---	
Source-Drain Characteristics ($T_J=25^{\circ}\text{C}$)						
V_{SD}	Diode Forward Voltage _z	$V_{GS}=0V, I_S=1A, T_J=25^{\circ}\text{C}$	---	---	1.2	V
t_{rr}	Reverse Recovery Time	$I_{DS}=15A, di/dt=100A/\mu s, T_J=25^{\circ}\text{C}$	---	12.2	---	nS
Q_{rr}	Reverse Recovery Charge		---	7.3	---	nC

Note ④ : Pulse test (pulse width $\leq 300\mu s$, duty cycle $\leq 2\%$).

Note ⑤ : Guaranteed by design, not subject to production testing.

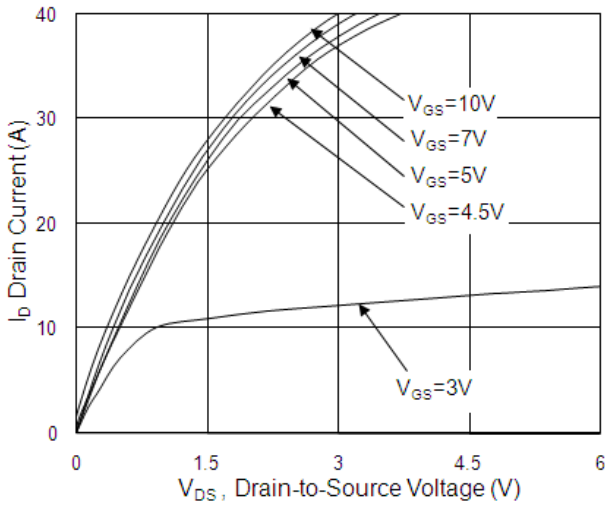
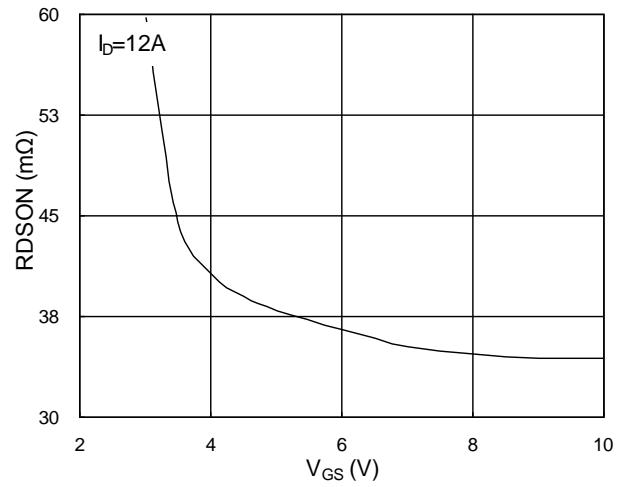
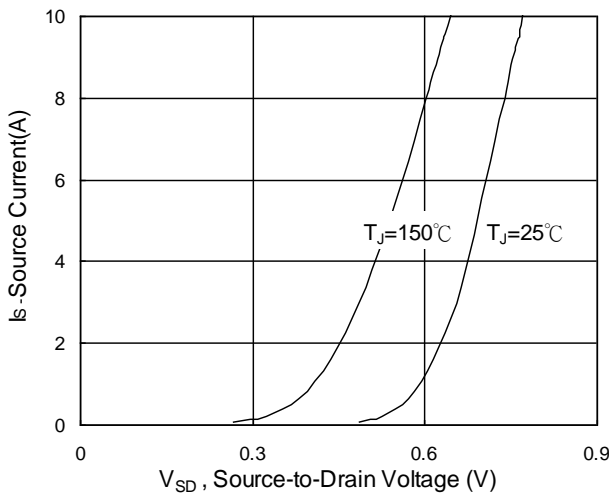
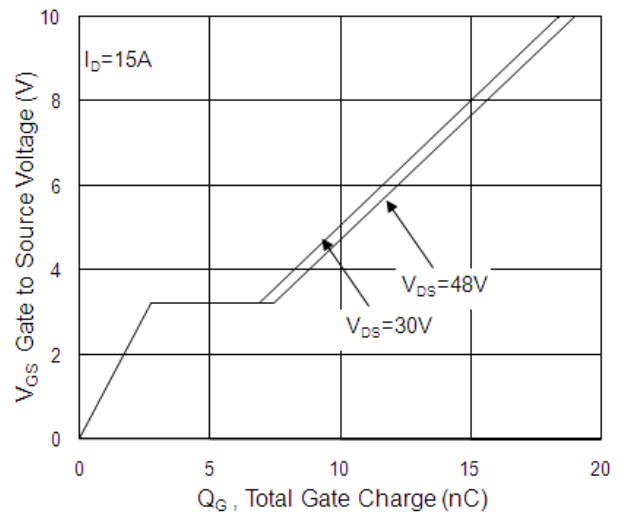
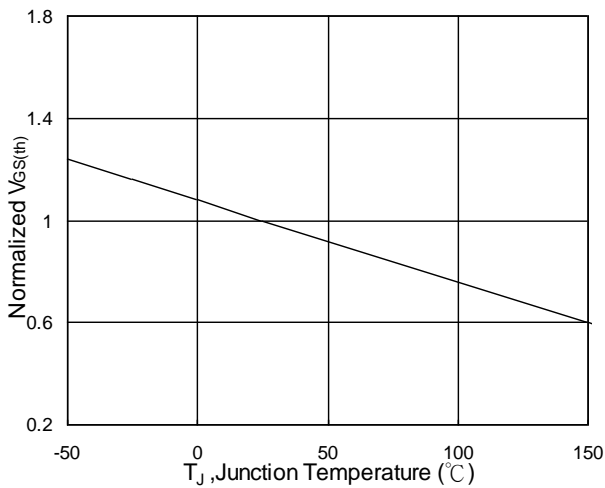
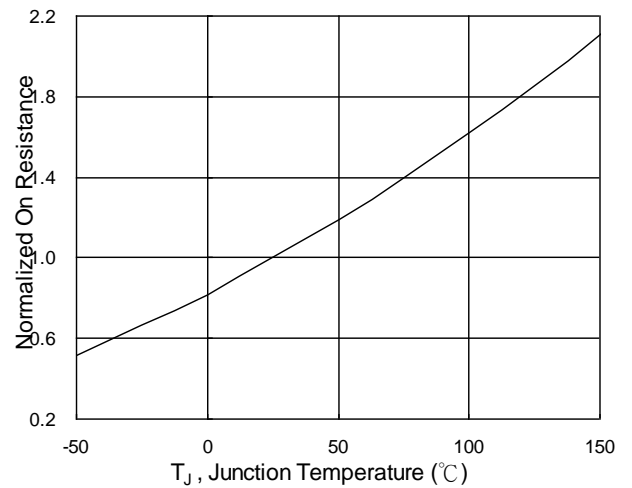
N-Channel Enhancement Mode MOSFET
Typical Characteristics

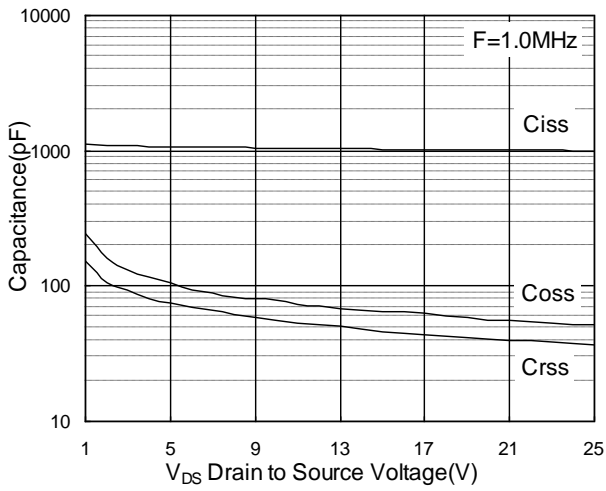
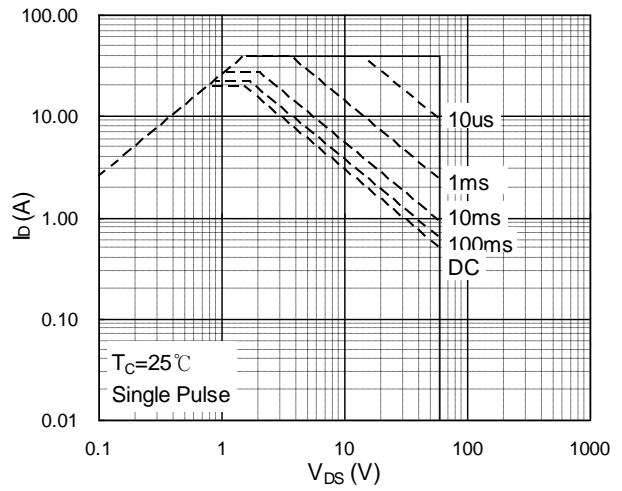
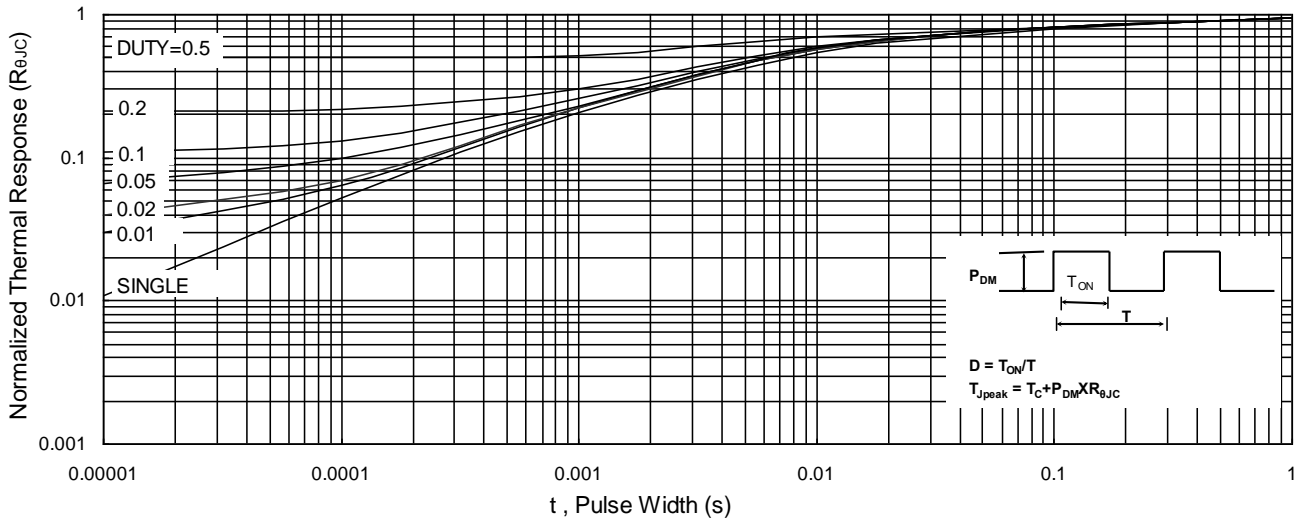
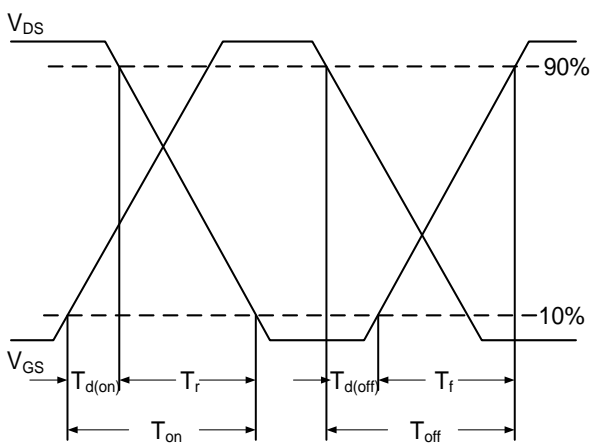
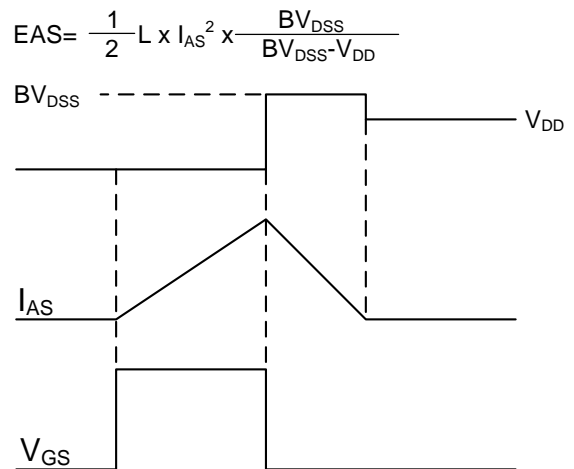
Fig.1 Typical Output Characteristics

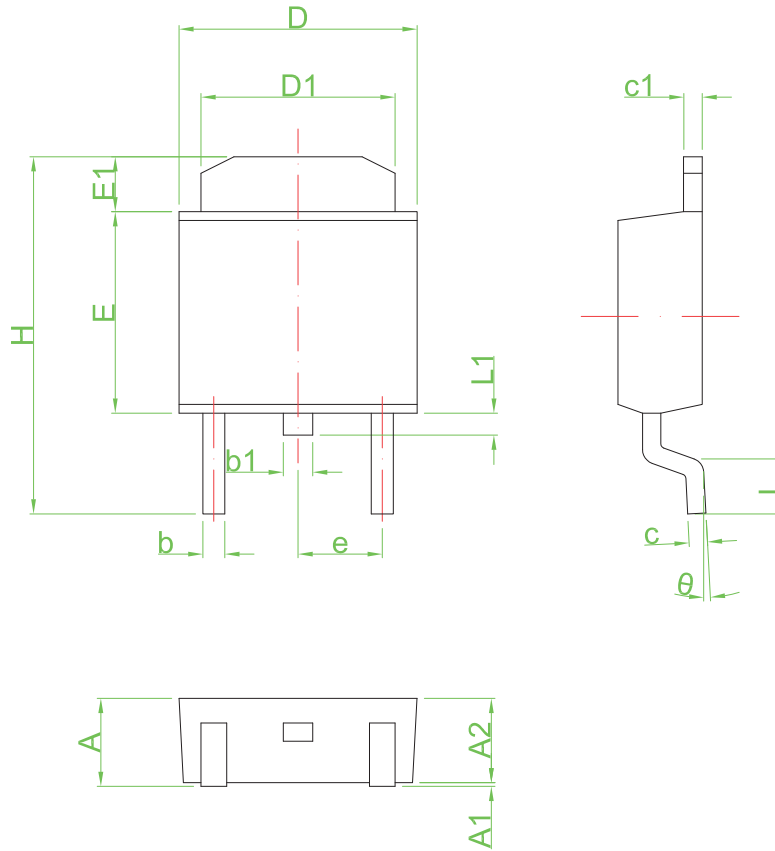
Fig.2 On-Resistance vs. Gate-Source

Fig.3 Forward Characteristics Of Reverse

Fig.4 Gate-Charge Characteristics

Fig.5 Normalized $V_{GS(th)}$ vs. T_J

Fig.6 Normalized R_{DSON} vs. T_J

N-Channel Enhancement Mode MOSFET

Fig.7 Capacitance

Fig.8 Safe Operating Area

Fig.9 Normalized Maximum Transient Thermal Impedance

Fig.10 Switching Time Waveform

Fig.11 Unclamped Inductive Switching Waveform

N-Channel Enhancement Mode MOSFET
TO-252 Package Outline Dimensions

Symbol	Dimensions in Millimeters		Dimensions in Inches	
	Min	Max	Min	Max
A	2.25	2.65	0.089	0.104
A1	0.00	0.15	0.000	0.006
A2	2.20	2.40	0.087	0.094
b	0.50	0.70	0.020	0.028
b1	0.70	0.90	0.028	0.035
c	0.46	0.66	0.018	0.026
c1	0.46	0.66	0.018	0.026
D	6.30	6.70	0.248	0.264
D1	5.20	5.40	0.205	0.213
E	5.30	5.70	0.209	0.224
E1	1.40	1.60	0.055	0.063
H	9.40	9.90	0.370	0.390
e	2.30 TYP		0.09 TYP	
L	1.40	1.77	0.055	0.070
L1	0.50	0.70	0.020	0.028
θ	0°	8°	0°	8°