

N-Channel Enhancement Mode MOSFET

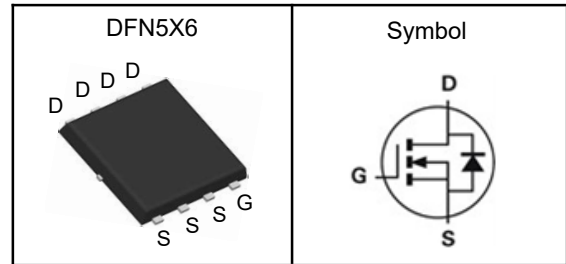
Features

- High Speed Power Switching
- Reliable and Rugged
- ROHS Compliant
- 100% Avalanche Tested

Applications

- Power Management in Desktop Computer
- DC/DC Converters

Pin Description



V_{DSS}	60	V
$R_{DS(ON)-Typ}$	4.5	m Ω
I_D	71	A

Absolute Maximum Ratings ($T_C=25^{\circ}C$, Unless Otherwise Noted)

Symbol	Parameter	N-Channel	Unit
V_{DSS}	Drain-Source Voltage	60	V
V_{GSS}	Gate-Source Voltage	± 20	V
T_J	Maximum Junction Temperature	-55 to 150	$^{\circ}C$
T_{STG}	Storage Temperature Range	-55 to 150	$^{\circ}C$
$I_{DM}^{①}$	Pulse Drain Current Tested	245	A
I_D	Continuous Drain Current	71	A
P_D	Maximum Power Dissipation	50	W
E_{AS}	Avalanche Energy, Single pulse	22	mJ

Thermal Characteristics

Symbol	Parameter	Rating	Unit
$R_{\theta JA}$	Thermal Resistance-Junction to Ambient	50	$^{\circ}C/W$
$R_{\theta JC}$	Thermal Resistance-Junction to Case	2.5	$^{\circ}C/W$

Note ① : Max. current is limited by bonding wire.

Note ② : UIS tested and pulse width are limited by maximum junction temperature 150 $^{\circ}C$.

Note ③ : Surface Mounted on 1in² FR-4 board with 1oz.



N-Channel Enhancement Mode MOSFET

Electrical Characteristics ($T_J=25^{\circ}\text{C}$, Unless Otherwise Noted)

Symbol	Parameter	Test Conditions	Min	Typ	Max	Unit
Static Electrical Characteristics						
BV_{DSS}	Drain-Source Breakdown Voltage	$V_{GS}=0V, I_D=250\mu A$	60	---	---	V
I_{DSS}	Zero Gate Voltage Drain Current	$V_{DS}=48V, V_{GS}=0V$	---	---	1	μA
$V_{GS(th)}$	Gate Threshold Voltage	$V_{DS}=V_{GS}, I_D=250\mu A$	1	1.8	2.5	V
I_{GSS}	Gate Leakage Current	$V_{GS}=\pm 20V, V_{DS}=0V$	---	---	± 100	nA
$R_{DS(on)}$	Drain-Source On-state Resistance	$V_{GS}=10V, I_D=20A$	---	4.5	6.0	$m\Omega$
		$V_{GS}=4.5V, I_D=10A$	---	7.2	9.5	$m\Omega$
Dynamic Characteristics ^⑤						
gfs	Forward Transconductance	$V_{DS}=5V, I_D=20A$	---	30	---	S
C_{iss}	Input Capacitance	$V_{DS}=30V, V_{GS}=0V, \text{Freq.}=1\text{MHz}$	---	2030	---	pF
C_{oss}	Output Capacitance		---	75	---	
C_{rss}	Reverse Transfer Capacitance		---	16	---	
$T_{d(on)}$	Turn-on Delay Time	$V_{DS}=30V, V_{GS}=10V, I_D=1A, R_G=3\Omega$	---	10	---	nS
T_r	Turn-on Rise Time		---	26	---	
$T_{d(off)}$	Turn-off Delay Time		---	29	---	
T_f	Turn-off Fall Time		---	20	---	
Q_g	Total Gate Charge	$V_{DS}=30V, V_{GS}=10V, I_D=20A$	---	38	---	nC
Q_{gs}	Gate-Source Charge		---	7	---	
Q_{gd}	Gate-Drain Charge		---	11	---	
Source-Drain Characteristics						
V_{SD}	Diode Forward Voltage	$I_S=1A, V_{GS}=0V$	---	---	1.2	V
t_{rr}	Reverse Recovery Time	$I_F=20A, V_R=75V, di_F/dt=100A/\mu s$	---	38	---	nS
Q_{rr}	Reverse Recovery Charge		---	46	---	nC

Note ④: Pulse test (pulse width $\leq 300\mu s$, duty cycle $\leq 2\%$).

Note ⑤: Guaranteed by design, not subject to production testing.

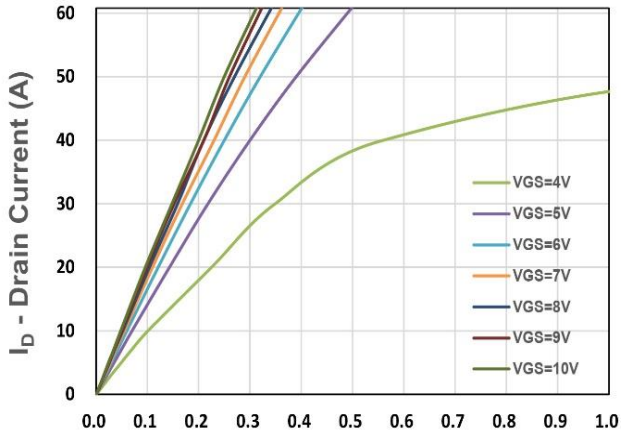
N-Channel Enhancement Mode MOSFET
Typical Characteristics


Figure 1. Output Characteristics

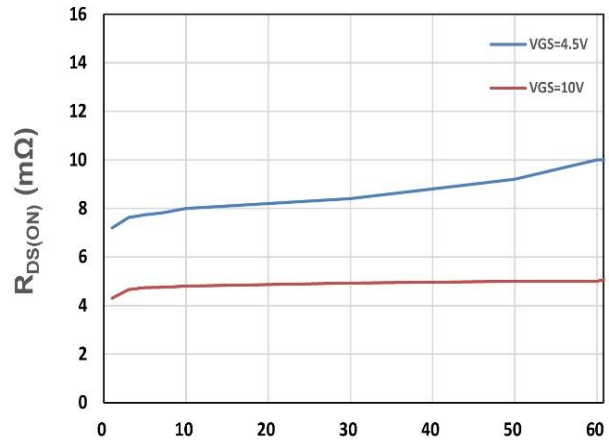


Figure 2. On-Resistance vs. I_D

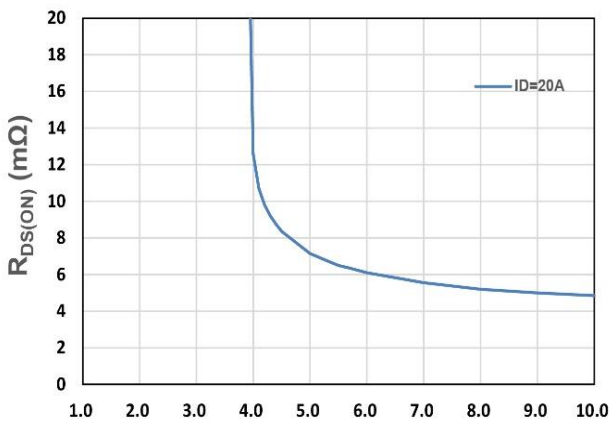


Figure 3. On-Resistance vs. V_{GS}

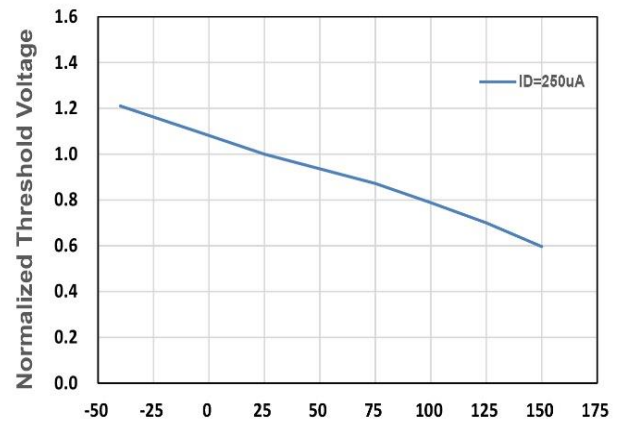


Figure 4. Gate Threshold Voltage

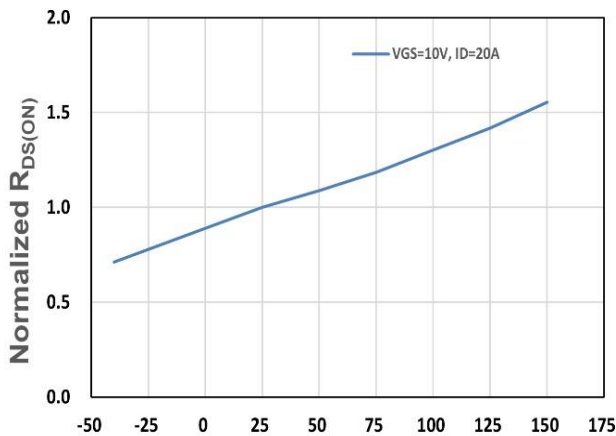


Figure 5. Drain-Source On Resistance

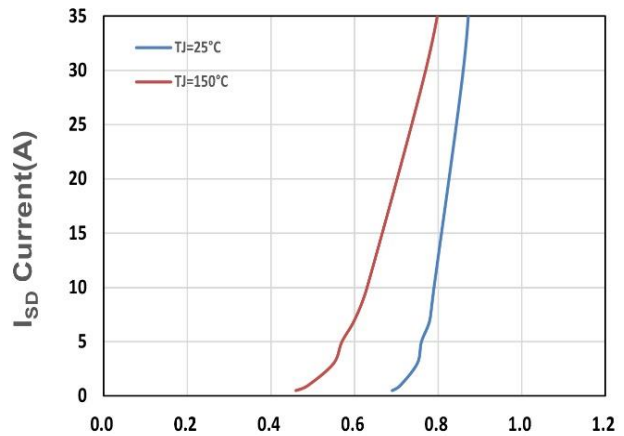
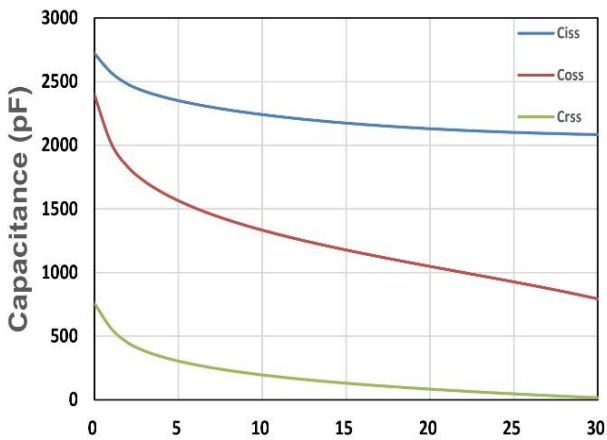


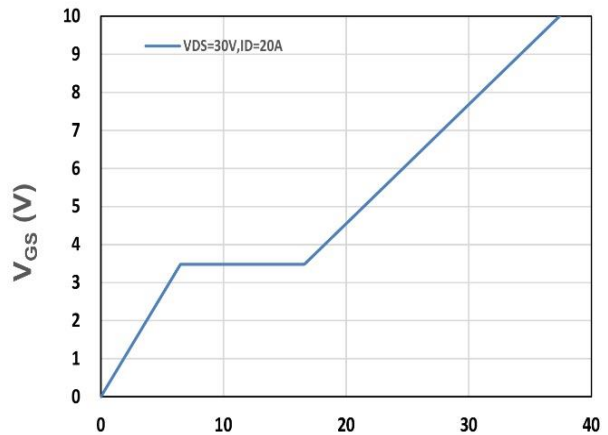
Figure 6. Source-Drain Diode Forward



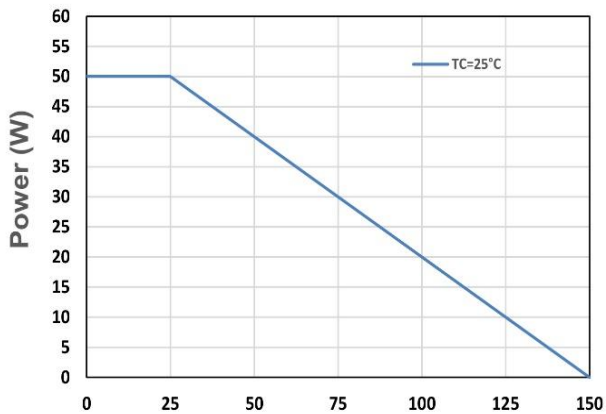
N-Channel Enhancement Mode MOSFET



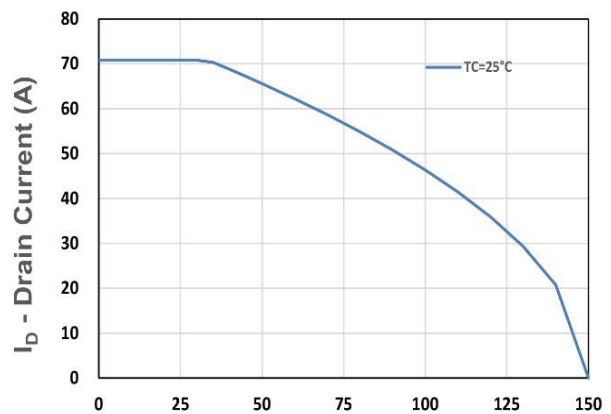
V_{DS} - Drain - Source Voltage (V)
Figure 7. Capacitance



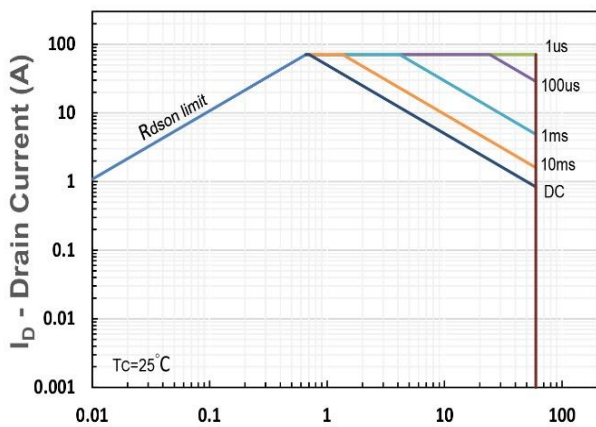
Q_g , Total Gate Charge (nC)
Figure 8. Gate Charge Characteristics



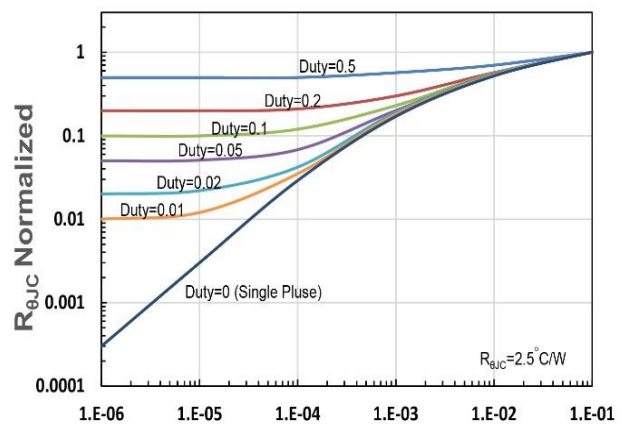
T_j - Junction Temperature (°C)
Figure 9. Power Dissipation



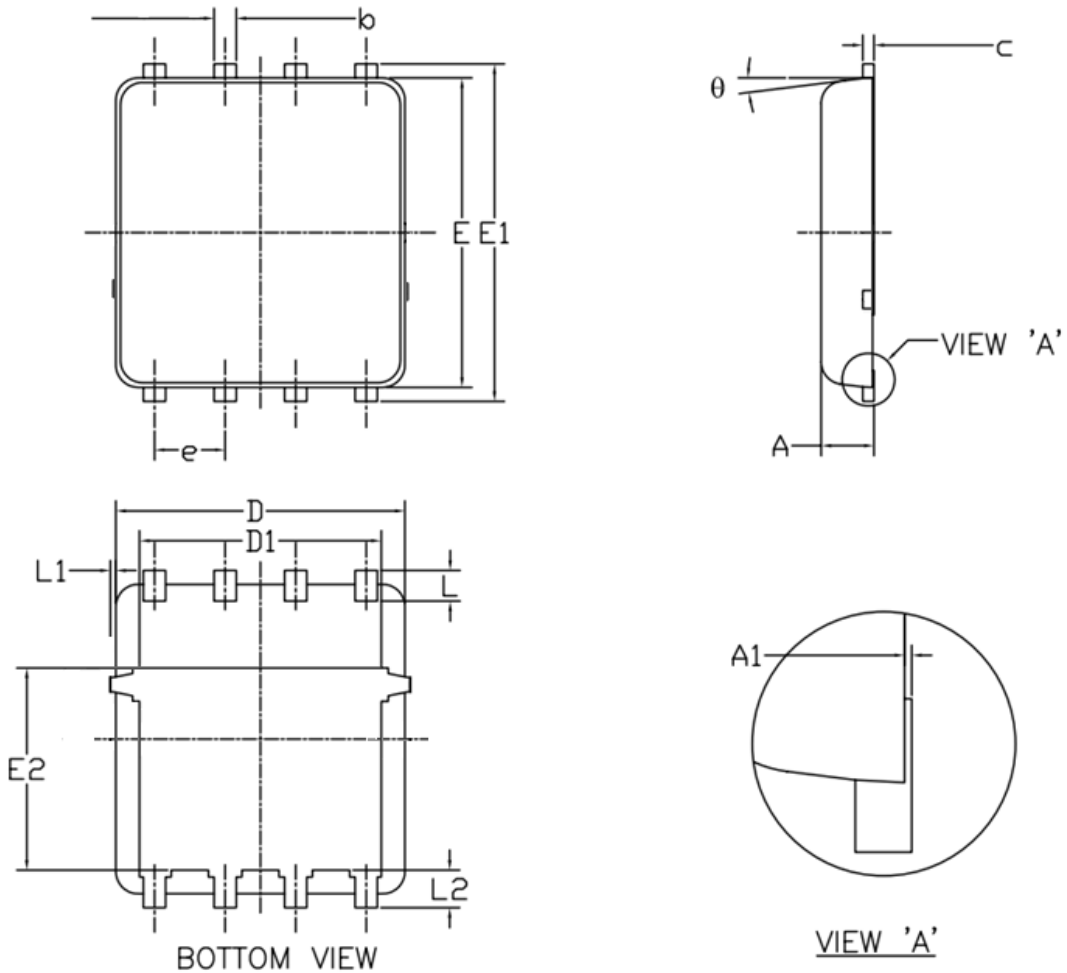
T_j - Junction Temperature (°C)
Figure 10. Drain Current



V_{DS} - Drain-Source Voltage (V)
Figure 11. Safe Operating Area



t_1 , Square Wave Pulse Duration(s)
Figure 12. $R_{\theta JC}$ Transient Thermal Impedance

N-Channel Enhancement Mode MOSFET
DFN5X6-8L Package Outline Dimensions


Symbol	Dimensions (unit:mm)			Symbol	Dimensions (unit:mm)		
	Min	Typ	Max		Min	Typ	Max
A	0.90	1.00	1.20	E1	5.90	6.10	6.35
A1	0.00	--	0.05	E2	3.38	3.58	3.92
b	0.30	0.40	0.51	e	1.27 BSC		
c	0.20	0.25	0.33	L	0.51	0.61	0.71
D	4.80	4.90	5.40	L1	--	--	0.15
D1	3.61	4.00	4.25	L2	0.41	0.51	0.61
E	5.65	5.80	6.06	θ	0°	--	12°