

N-Channel Enhancement Mode MOSFET

Features

- High Speed Power Switching
- Reliable and Rugged
- ROHS Compliant
- 100% Avalanche Tested

Applications

- Power Management in Desktop Computer
- DC/DC Converters

Pin Description

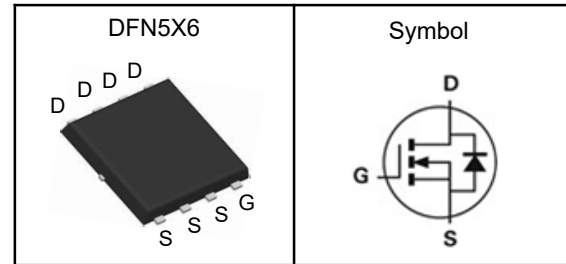

V_{DSS}	60	V
$R_{DS(ON)-Typ}$	2.0	m Ω
I_D	150	A

Absolute Maximum Ratings ($T_C=25^\circ\text{C}$, Unless Otherwise Noted)

Symbol	Parameter	Rating	Unit
V_{DSS}	Drain-Source Voltage	60	V
V_{GSS}	Gate-Source Voltage	± 20	V
T_J	Maximum Junction Temperature	-55 to 150	$^\circ\text{C}$
T_{STG}	Storage Temperature Range	-55 to 150	$^\circ\text{C}$
$I_{DM}^{①}$	Pulse Drain Current Tested	450	A
I_D	Continuous Drain Current	150	A
P_D	Maximum Power Dissipation	85	W
E_{AS}	Avalanche Energy, Single pulse	250	mJ

Thermal Characteristics

Symbol	Parameter	Rating	Unit
$R_{\theta JA}$	Thermal Resistance-Junction to Ambient	62.5	$^\circ\text{C/W}$
$R_{\theta JC}$	Thermal Resistance-Junction to Case	1.47	$^\circ\text{C/W}$

Note ① : Max. current is limited by bonding wire.

Note ② : UIS tested and pulse width are limited by maximum junction temperature 150°C .

Note ③ : Surface Mounted on 1in^2 FR-4 board with 1oz.



N-Channel Enhancement Mode MOSFET

Electrical Characteristics ($T_J=25^{\circ}\text{C}$, Unless Otherwise Noted)

Symbol	Parameter	Test Conditions	Min	Typ	Max	Unit
Static Electrical Characteristics						
BV_{DSS}	Drain-Source Breakdown Voltage	$V_{GS}=0V, I_D=250\mu A$	60	---	---	V
I_{DSS}	Zero Gate Voltage Drain Current	$V_{DS}=60V, V_{GS}=0V$	---	---	1	μA
$V_{GS(th)}$	Gate Threshold Voltage	$V_{DS}=V_{GS}, I_D=250\mu A$	1	---	2.1	V
I_{GSS}	Gate Leakage Current	$V_{GS}=\pm 20V, V_{DS}=0V$	---	---	± 100	nA
$R_{DS(on)}$	Drain-Source On-state Resistance	$V_{GS}=10V, I_D=20A$	---	2.0	2.5	$m\Omega$
		$V_{GS}=4.5V, I_D=20A$	---	2.6	3.4	$m\Omega$
Dynamic Characteristics ^⑤						
C_{iss}	Input Capacitance	$V_{DS}=25V, V_{GS}=0V, \text{Freq.}=500\text{KHz}$	---	5460	---	pF
C_{oss}	Output Capacitance		---	1290	---	
C_{rSS}	Reverse Transfer Capacitance		---	13	---	
$T_{d(on)}$	Turn-on Delay Time	$V_{DS}=30V, V_{GS}=10V, I_D=60A, R_G=4.7\Omega$	---	20	---	nS
T_r	Turn-on Rise Time		---	127	---	
$T_{d(off)}$	Turn-off Delay Time		---	95	---	
T_f	Turn-off Fall Time		---	25	---	
Q_g	Total Gate Charge	$V_{DS}=30V, V_{GS}=10V, I_D=30A$	---	86	---	nC
Q_{gs}	Gate-Source Charge		---	14	---	
Q_{gd}	Gate-Drain Charge		---	14	---	
Source-Drain Characteristics						
V_{SD}	Diode Forward Voltage	$I_S=30A, V_{GS}=0V$	---	---	1.4	V
t_{rr}	Reverse Recovery Time	$I_S=30A, di_F/dt=80A/\mu s$	---	63	---	nS
Q_{rr}	Reverse Recovery Charge		---	59	---	nC

Note ④: Pulse test (pulse width $\leq 300\mu s$, duty cycle $\leq 2\%$).

Note ⑤: Guaranteed by design, not subject to production testing.

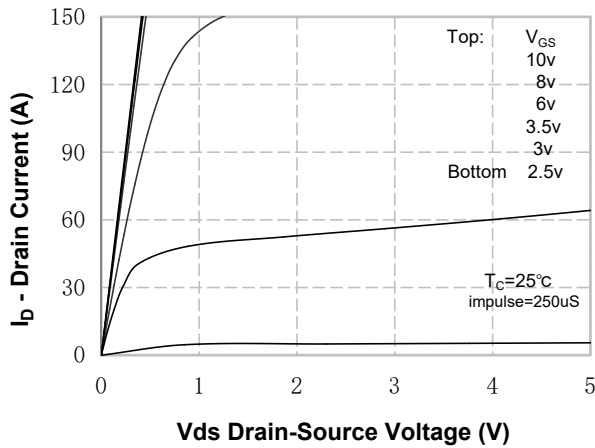
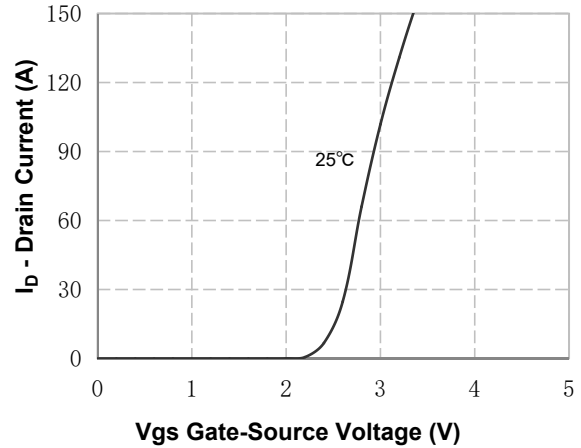
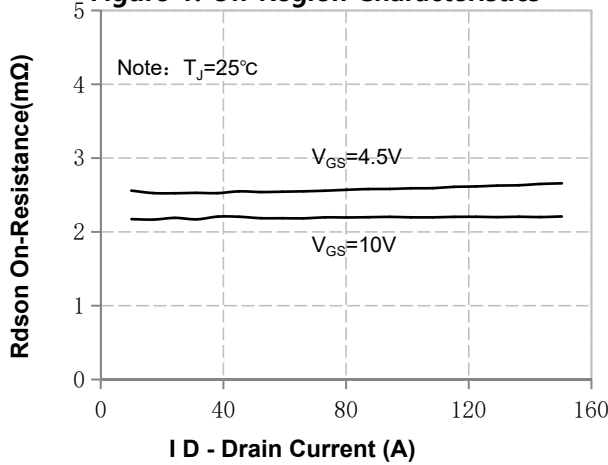
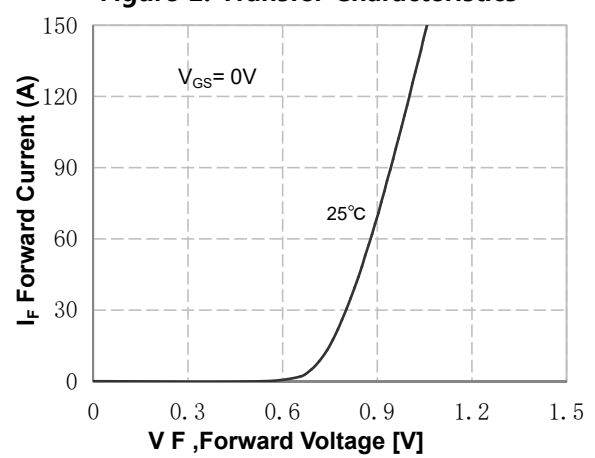
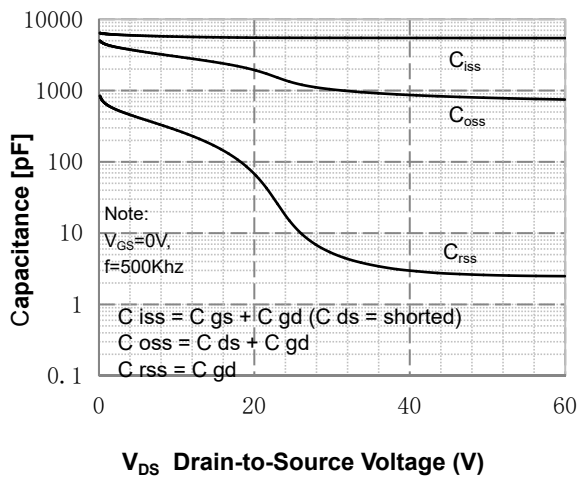
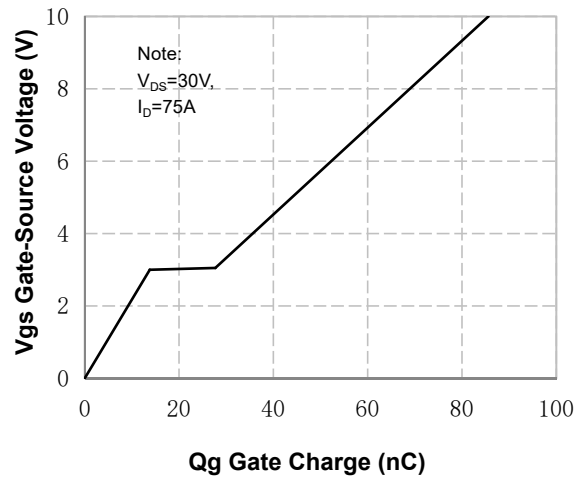
N-Channel Enhancement Mode MOSFET
Typical Characteristics

Figure 1. On-Region Characteristics

Figure 2. Transfer Characteristics

Figure 3. On-Resistance Variation vs Drain Current and Gate Voltage

Figure 4. Body Diode Forward Voltage Variation with Source Current

Figure 5. Capacitance Characteristics

Figure 6. Gate Charge Characteristics

N-Channel Enhancement Mode MOSFET

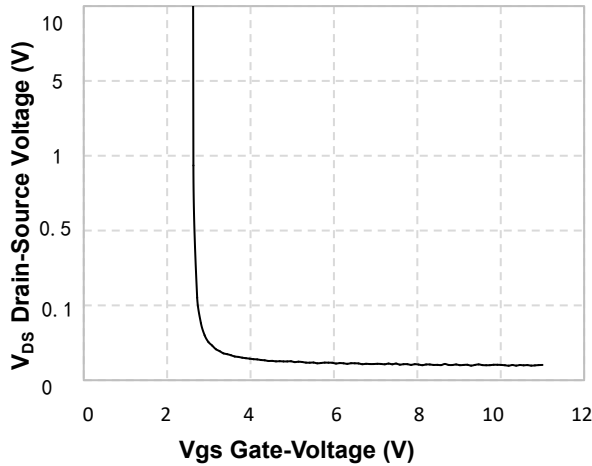

Figure 7. V_{DS} Drain-Source Voltage vs Gate Voltage

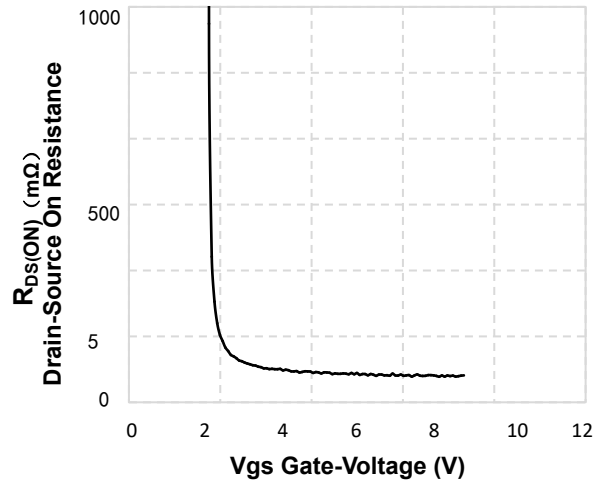

Figure 8. On-Resistance vs Gate Voltage

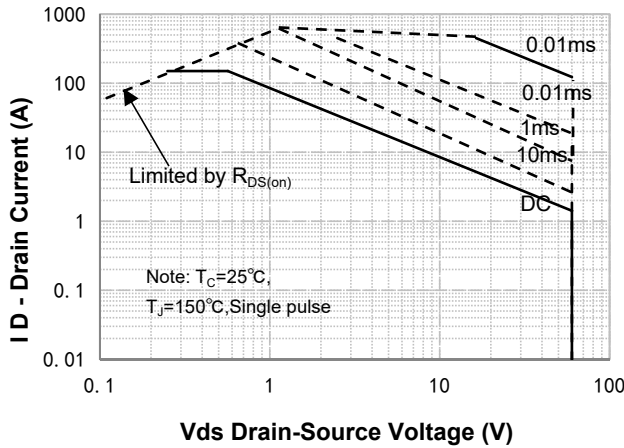

Figure 9. Maximum Safe Operating Area

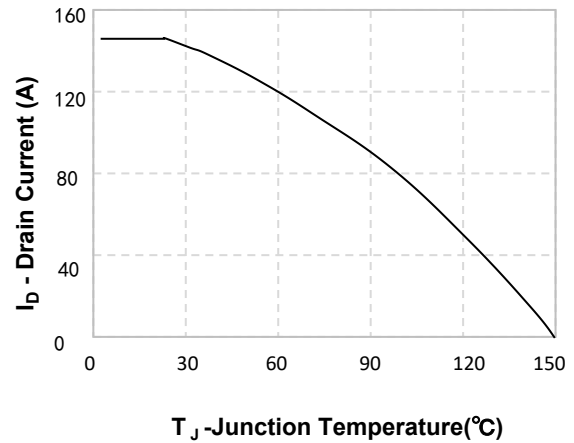

Figure 10. Maximum Continuous Drain Current vs Temperature

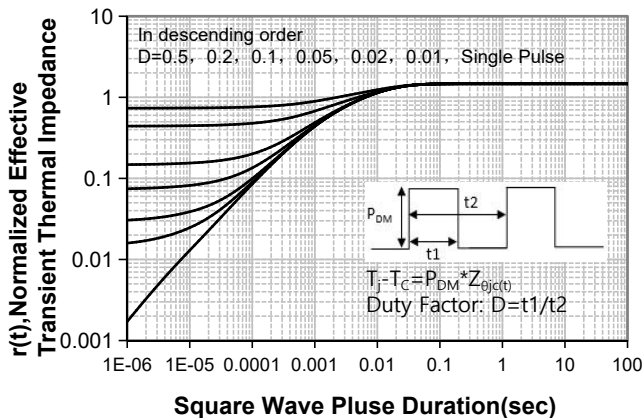
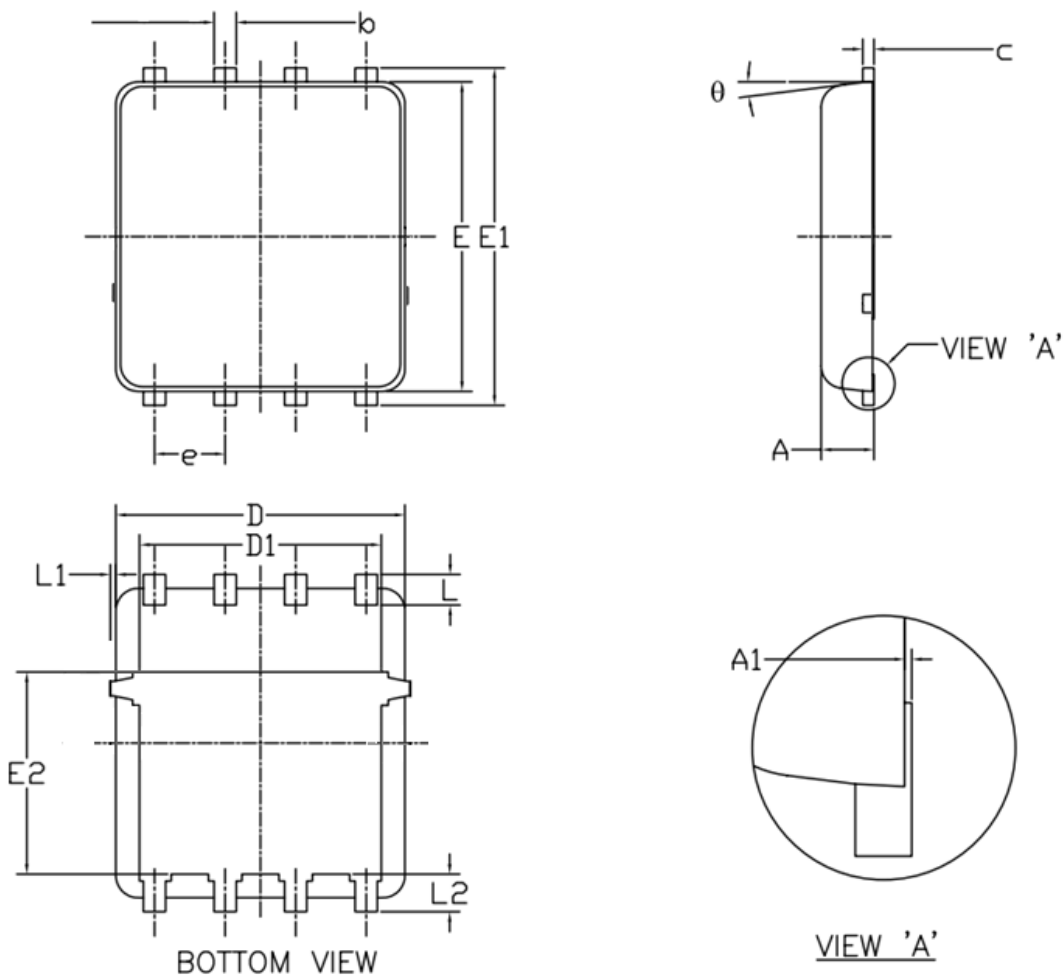

Figure 11. Transient Thermal Response Curve

N-Channel Enhancement Mode MOSFET
DFN5X6-8L Package Outline Dimensions

Symbol	Dimensions (unit:mm)			Symbol	Dimensions (unit:mm)		
	Min	Typ	Max		Min	Typ	Max
A	0.90	1.00	1.20	E1	5.90	6.10	6.35
A1	0.00	--	0.05	E2	3.38	3.58	3.92
b	0.30	0.40	0.51	e	1.27 BSC		
c	0.20	0.25	0.33	L	0.51	0.61	0.71
D	4.80	4.90	5.40	L1	--	--	0.15
D1	3.61	4.00	4.25	L2	0.41	0.51	0.61
E	5.65	5.80	6.06	theta	0°	--	12°