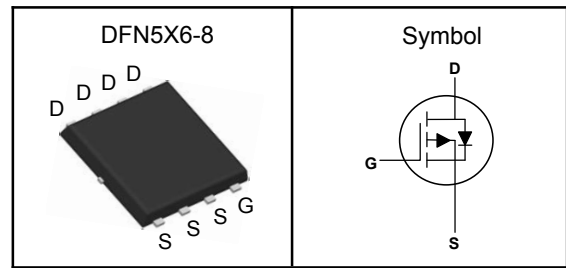

P-Channel Enhancement Mode MOSFET
Features

- Low $R_{ds(on)}$ for low conduction loss
- Reliable and Rugged
- ROHS Compliant & Halogen-Free

Applications

- Power Management in Desktop Computer
- DC/DC Converters

Pin Description

V_{bss}	-30	V
$R_{ds(ON)-Typ}$	12	m Ω
I_D	-42	A

Absolute Maximum Ratings ($T_C=25^\circ\text{C}$, Unless Otherwise Noted)

Symbol	Parameter	P-Channel	Unit
V_{bss}	Drain-Source Voltage	-30	V
V_{GSS}	Gate-Source Voltage	± 20	V
T_J	Maximum Junction Temperature	-55 to 150	$^\circ\text{C}$
T_{STG}	Storage Temperature Range	-55 to 150	$^\circ\text{C}$
$I_{DM}^{①}$	Pulse Drain Current Tested	-60	A
I_D	Continuous Drain Current	$T_C=25^\circ\text{C}$ -42	A
P_D	Maximum Power Dissipation	$T_C=25^\circ\text{C}$ 31	W
EAS	Single Pulse Avalanche Energy	$L=0.3\text{mH}$ 101	mJ

Thermal Characteristics

Symbol	Parameter	Rating	Unit
$R_{\theta JA}^{③}$	Thermal Resistance-Junction to Ambient Steady State	55	$^\circ\text{C/W}$
$R_{\theta JC}$	Thermal Resistance Junction-Case Steady State	11	$^\circ\text{C/W}$

Note ① : Max. current is limited by bonding wire.

Note ② : UIS tested and pulse width are limited by maximum junction temperature 150°C .

Note ③ : Surface Mounted on 1in^2 FR-4 board with 1oz.



P-Channel Enhancement Mode MOSFET

Electrical Characteristics ($T_J=25^{\circ}\text{C}$, Unless Otherwise Noted)

Symbol	Parameter	Test Conditions	Min	Typ	Max	Unit
Static Electrical Characteristics						
BV_{DSS}	Drain-Source Breakdown Voltage	$V_{GS}=0V, I_D=-250\mu A$	-30	---	---	V
I_{DSS}	Zero Gate Voltage Drain Current	$V_{DS}=-24V, V_{GS}=0V$	---	---	-1	μA
$V_{GS(th)}$	Gate Threshold Voltage	$V_{DS}=V_{GS}, I_D=-250\mu A$	-1.5	---	-2.5	V
I_{GSS}	Gate Leakage Current	$V_{GS}=\pm 20V, V_{DS}=0V$	---	---	± 100	nA
$R_{DS(on)}$	Drain-Source On-state Resistance	$V_{GS}=-10V, I_D=-15A$	---	9.6	12	$m\Omega$
		$V_{GS}=-4.5V, I_D=-5A$	---	15	21	$m\Omega$
Dynamic Characteristics^⑤						
C_{iss}	Input Capacitance	$V_{GS}=0V, V_{DS}=-15V, \text{Freq.}=1\text{MHz}$	---	1550	---	pF
C_{oss}	Output Capacitance		---	315	---	
C_{rss}	Reverse Transfer Capacitance		---	245	---	
$T_{d(on)}$	Turn-on Delay Time	$V_{DD}=-15V, V_{GS}=-10V, R_G=6\Omega, I_D=-1A, R_L=15\Omega$	---	13	---	nS
T_r	Turn-on Rise Time		---	15	---	
$T_{d(off)}$	Turn-off Delay Time		---	50	---	
T_f	Turn-off Fall Time		---	29	---	
Q_g	Total Gate Charge	$V_{DS}=-15V, V_{GS}=-10V, I_D=-15A$	---	31	---	nC
Q_{gs}	Gate-Source Charge		---	4.3	---	
Q_{gd}	Gate-Drain Charge		---	10	---	
Source-Drain Characteristics ($T_J=25^{\circ}\text{C}$)						
$V_{SD}^{④}$	Diode Forward Voltage	$V_{GS}=0V, I_S=-1A, T_J=25^{\circ}\text{C}$	---	-0.7	-1.0	V
t_{rr}	Reverse Recovery Time	$I_F=-15A, di/dt=100A/\mu s, T_J=25^{\circ}\text{C}$	---	22	---	nS
Q_{rr}	Reverse Recovery Charge		---	15	---	nC

Note ④: Pulse test (pulse width 300us, duty cycle 2%).

Note ⑤: Guaranteed by design, not subject to production testing.

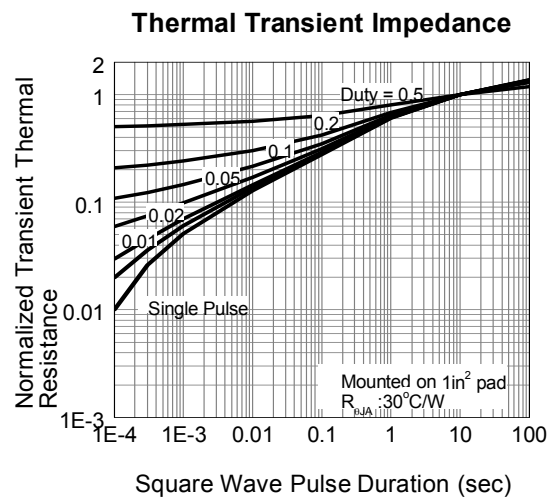
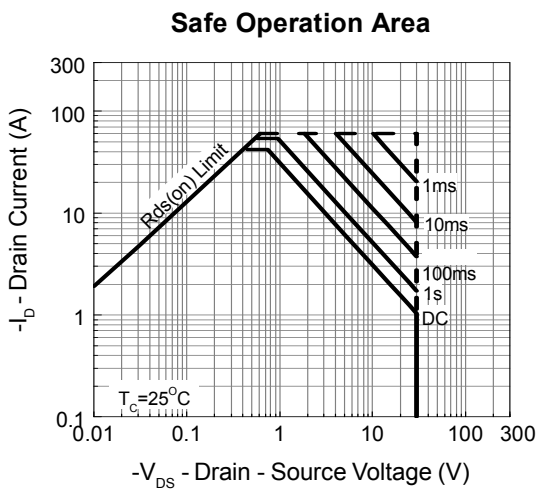
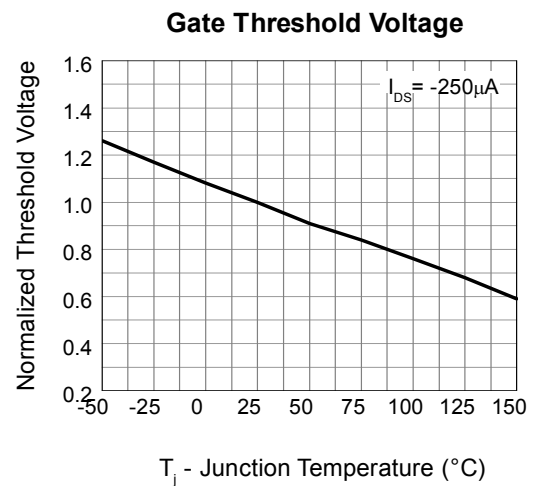
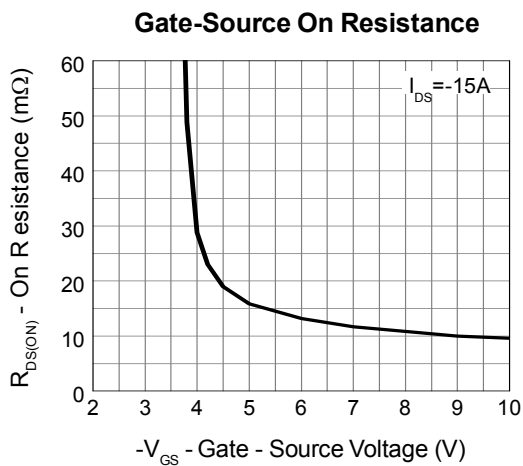
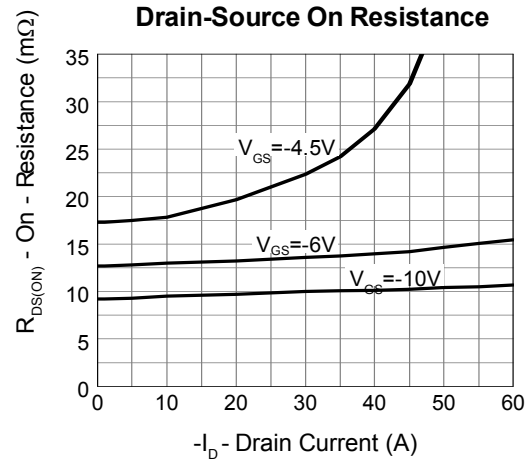
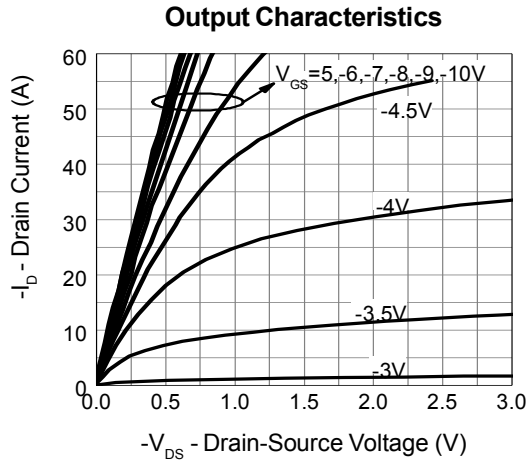
P-Channel Enhancement Mode MOSFET
Typical Characteristics

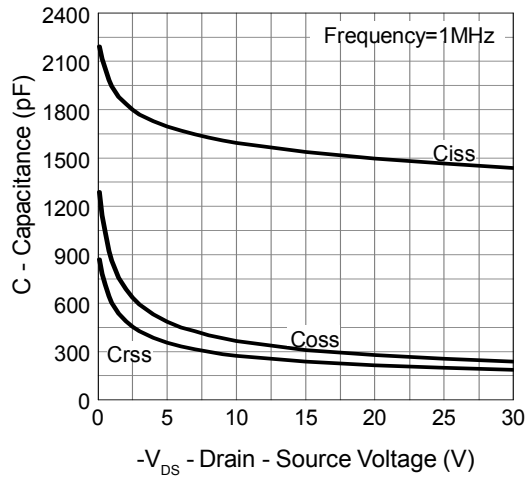
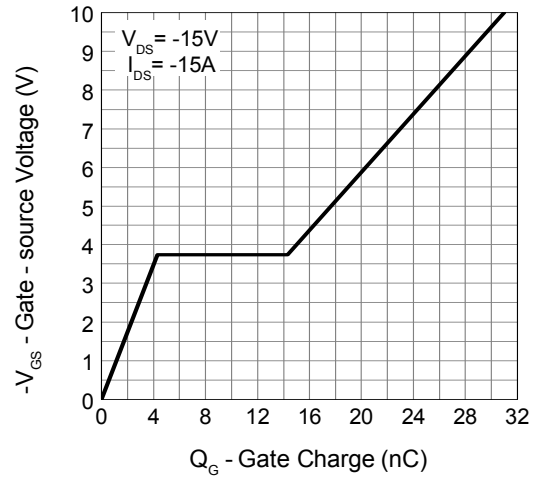
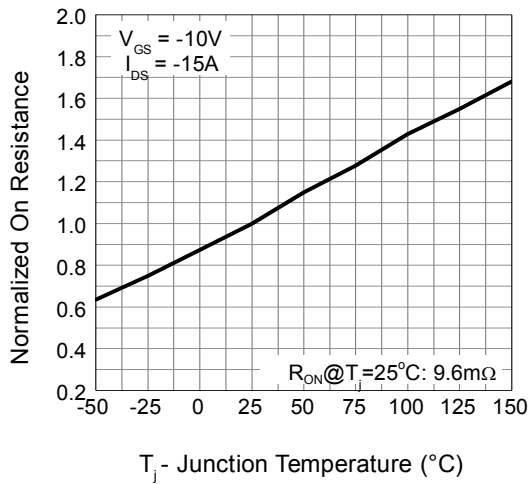
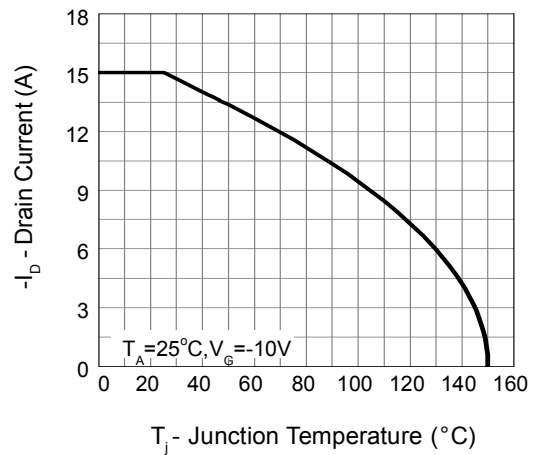
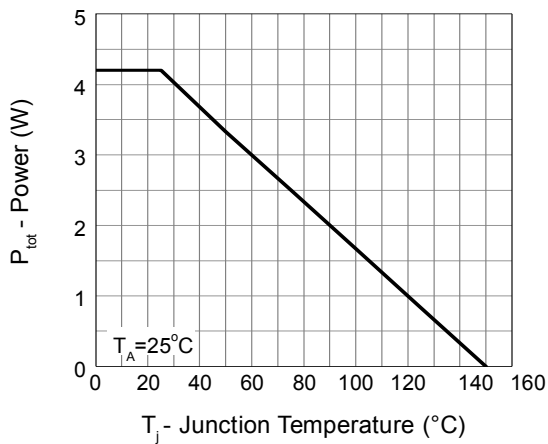
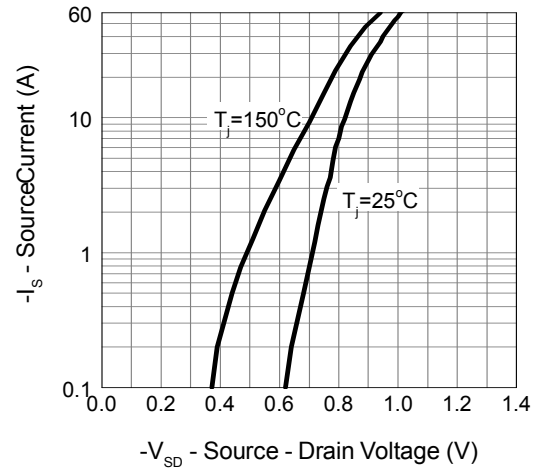
P-Channel Enhancement Mode MOSFET
Capacitance

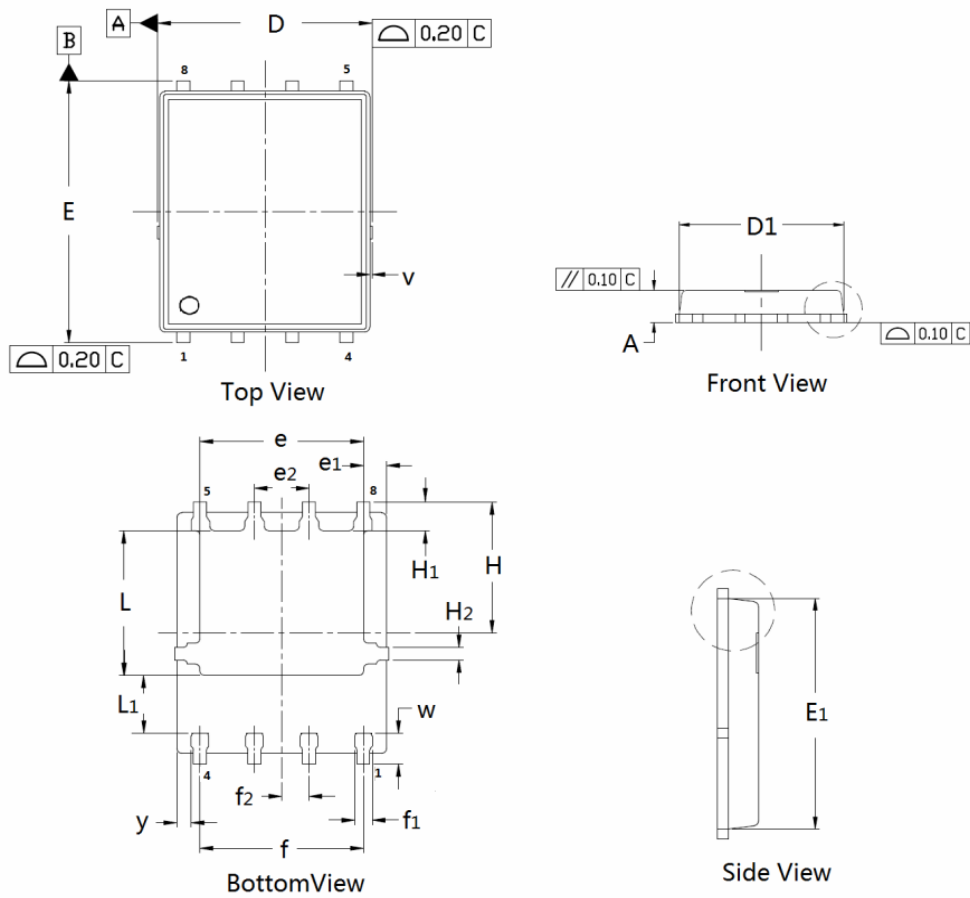
Gate Charge

Drain-Source On Resistance

Source-Drain Diode Forward

P-Channel Enhancement Mode MOSFET
DFN5×6 Package Outline Data

DIMENSIONS (unit : mm)

Symbol		Typ	Max	Symbol	Min	Typ	Max
A	0.90	1.02	1.10	D	4.90	4.98	5.10
D ₁	4.80	4.89	5.10	E	5.90	6.11	6.25
E ₁	5.65	5.74	5.95	e	3.72	3.80	3.92
e ₁	--	0.5	--	e ₂	--	1.	--
f	--	3.8	--	f ₁	0.31	0.37	0.51
f ₂	--	0.6	--	H	--	3.	--
H ₁	0.59	0.63	0.79	H ₂	0.26	0.28	0.32
L	3.35	3.45	3.65	L ₁	--	1.	--
v	--	0.1	--	w	0.64	0.68	0.84
y	--	0.3	--		--		--