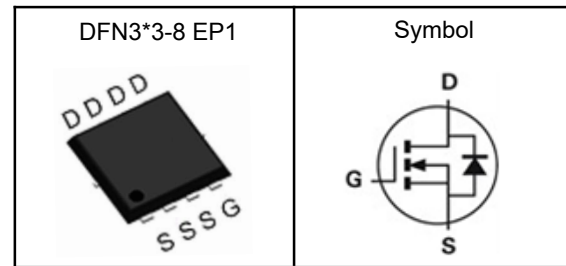

N-Channel Enhancement Mode MOSFET
Features

- Fast switching speed
- Reliable and Rugged
- ROHS Compliant
- 100% Avalanche Tested

Applications

- Power Management in Desktop Computer
- DC/DC Converters

Pin Description

V_{DSS}	30	V
$R_{DS(ON)-Typ}$	7	m Ω
I_D	46	A

Absolute Maximum Ratings ($T_C=25^\circ\text{C}$, Unless Otherwise Noted)

Symbol	Parameter	N-Channel	Unit
V_{DSS}	Drain-Source Voltage	30	V
V_{GSS}	Gate-Source Voltage	± 20	V
T_J	Maximum Junction Temperature	-55 to 150	$^\circ\text{C}$
T_{STG}	Storage Temperature Range	-55 to 150	$^\circ\text{C}$
$I_{DM}^{①}$	Pulse Drain Current Tested	92	A
I_D	Continuous Drain Current	46	A
P_D	Maximum Power Dissipation	29	W
E_{AS}	Avalanche Energy, Single pulse	57.8	mJ

Thermal Characteristics

Symbol	Parameter	Rating	Unit
$R_{\theta JA}$	Thermal Resistance-Junction to Ambient	75	$^\circ\text{C/W}$
$R_{\theta JC}$	Thermal Resistance-Junction to Case	4.32	$^\circ\text{C/W}$

Note ① : Max. current is limited by bonding wire.

Note ② : UIS tested and pulse width are limited by maximum junction temperature 150°C .

Note ③ : Surface Mounted on 1in^2 FR-4 board with 1oz.



N-Channel Enhancement Mode MOSFET

Electrical Characteristics ($T_J=25^{\circ}\text{C}$, Unless Otherwise Noted)

Symbol	Parameter	Test Conditions	Min	Typ	Max	Unit
Static Electrical Characteristics						
BV_{DSS}	Drain-Source Breakdown Voltage	$V_{GS}=0V, I_D=250\mu A$	30	---	---	V
I_{DSS}	Zero Gate Voltage Drain Current	$V_{DS}=24V, V_{GS}=0V$	---	---	1	μA
$V_{GS(th)}$	Gate Threshold Voltage	$V_{DS}=V_{GS}, I_D=250\mu A$	1	---	2.5	V
I_{GSS}	Gate Leakage Current	$V_{GS}=\pm 20V, V_{DS}=0V$	---	---	± 100	nA
$R_{DS(on)}$	Drain-Source On-state Resistance	$V_{GS}=10V, I_D=12A$	---	7	8.5	m Ω
		$V_{GS}=4.5V, I_D=10A$	---	10	13	m Ω
Dynamic Characteristics ^⑤						
C_{iss}	Input Capacitance	$V_{GS}=0V, V_{DS}=15V, \text{Freq.}=1\text{MHz}$	---	1317	---	pF
C_{oss}	Output Capacitance		---	163	---	
C_{rss}	Reverse Transfer Capacitance		---	131	---	
$T_{d(on)}$	Turn-on Delay Time	$V_{DD}=12V, V_{GS}=10V, R_G=3.3\Omega, I_D=5A$	---	4.5	---	nS
T_r	Turn-on Rise Time		---	10.8	---	
$T_{d(off)}$	Turn-off Delay Time		---	25.5	---	
T_f	Turn-off Fall Time		---	9.6	---	
Q_g	Total Gate Charge	$V_{GS}=10V, V_{DS}=4.5V, I_D=12A$	---	12.8	---	nC
Q_{gs}	Gate-Source Charge		---	3.3	---	
Q_{gd}	Gate-Drain Charge		---	6.5	---	
Source-Drain Characteristics						
V_{SD}	Diode Forward Voltage	$I_S=1A, V_{GS}=0V$	---	---	1.0	V
I_S	Continuous Source Current ^{1,5}	$V_G=V_D=0V, \text{Force Current}$	---	---	46	A
I_{SM}	Pulsed Source Current ^{2,5}		---	---	92	A

Note ④: Pulse test (pulse width $\leq 300\mu s$, duty cycle $\leq 2\%$).

Note ⑤: Guaranteed by design, not subject to production testing.

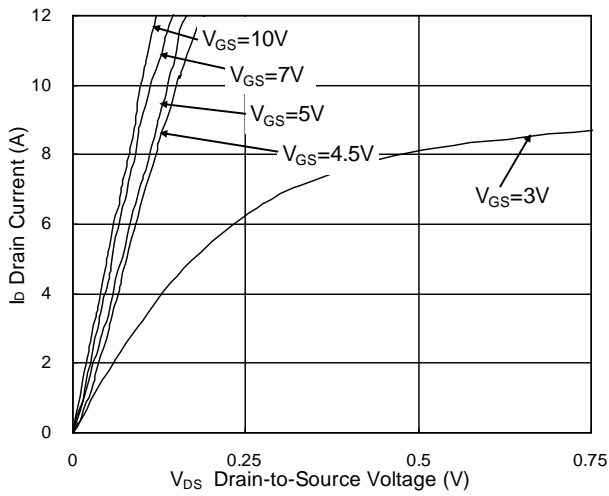
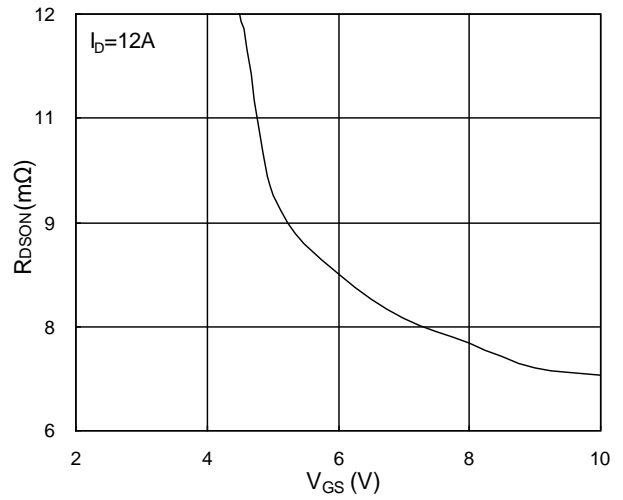
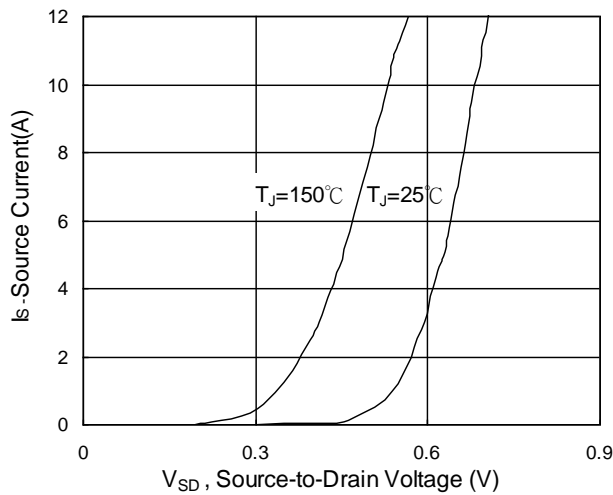
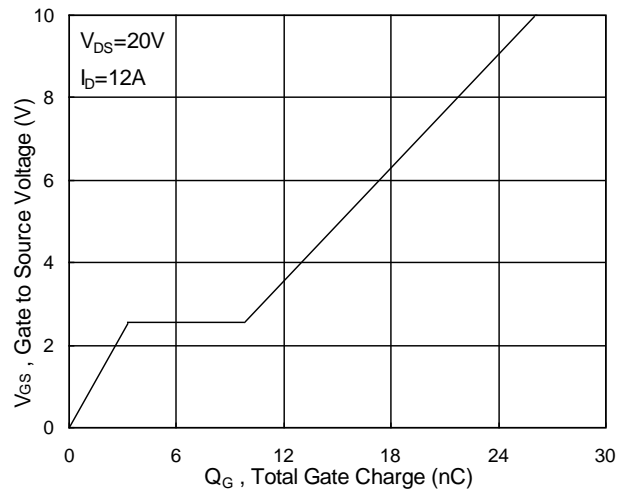
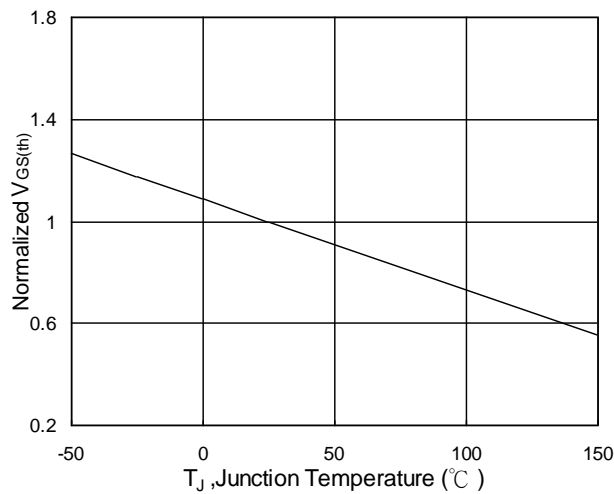
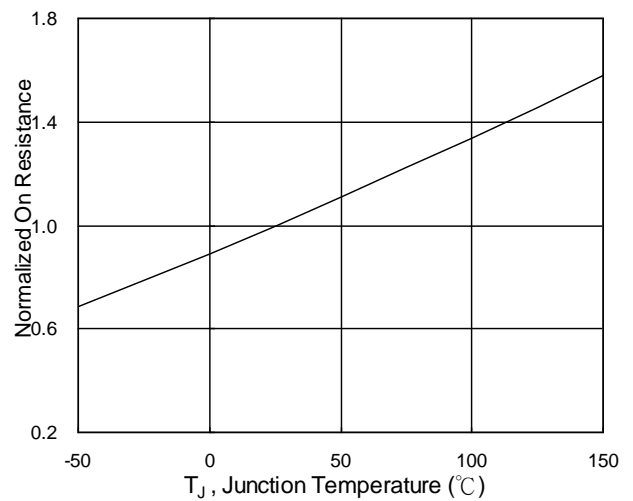
N-Channel Enhancement Mode MOSFET
Typical Characteristics

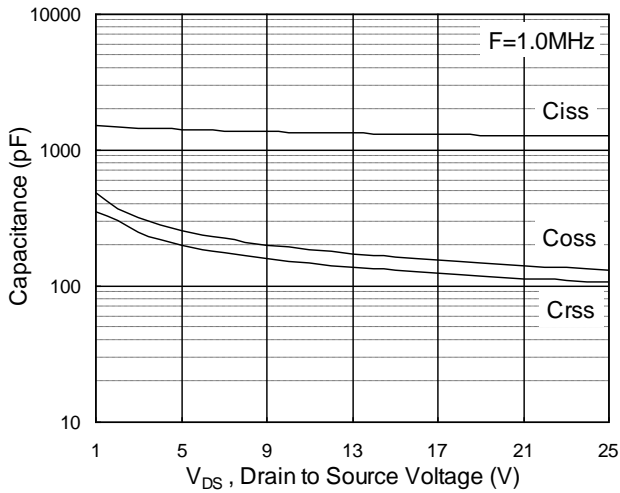
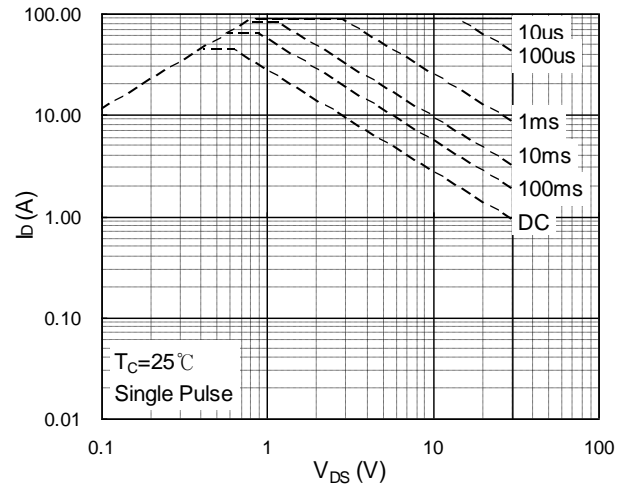
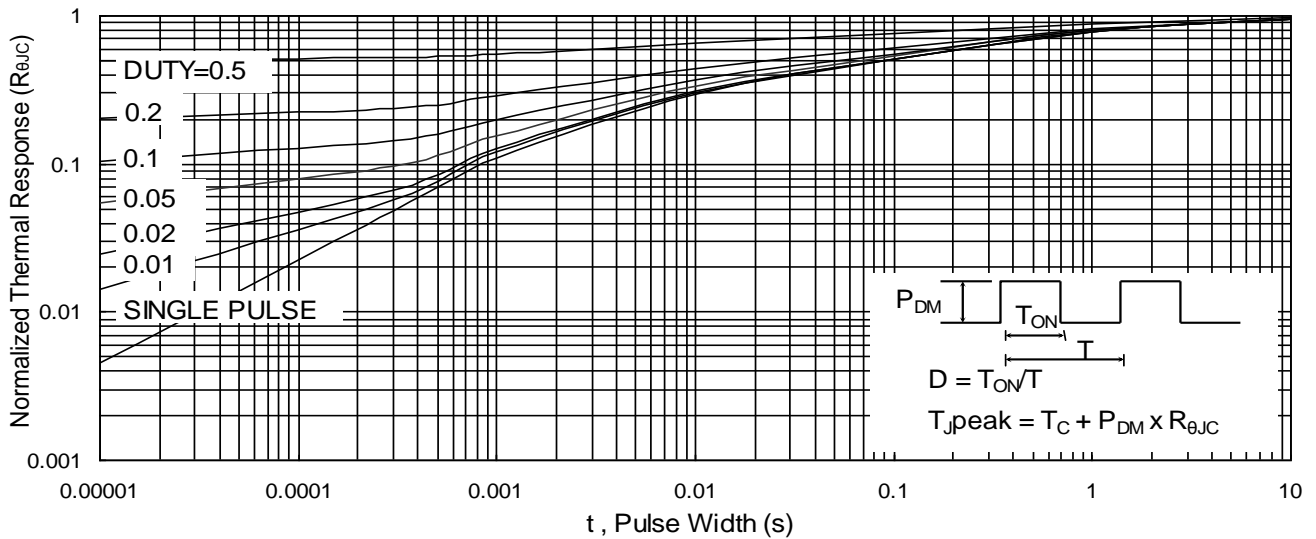
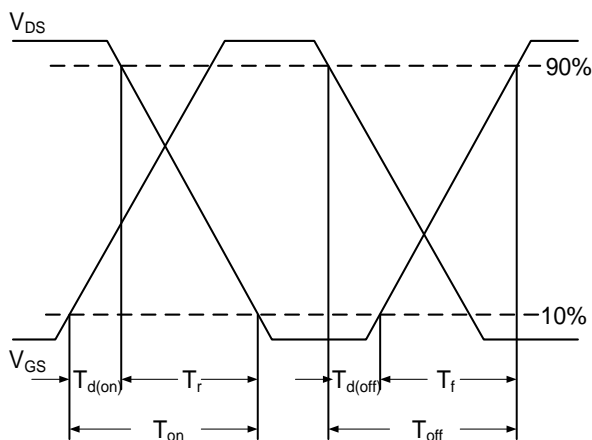
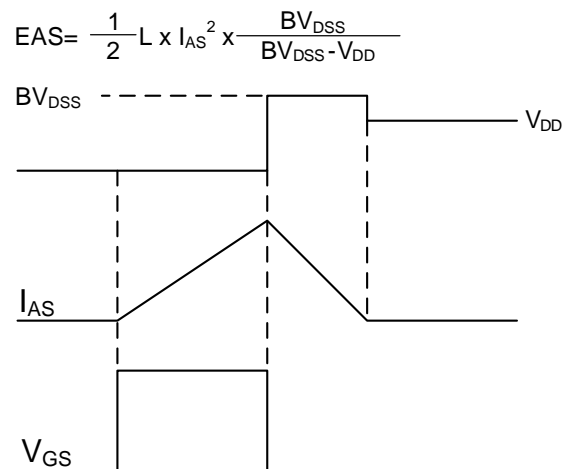
Fig.1 Typical Output Characteristics

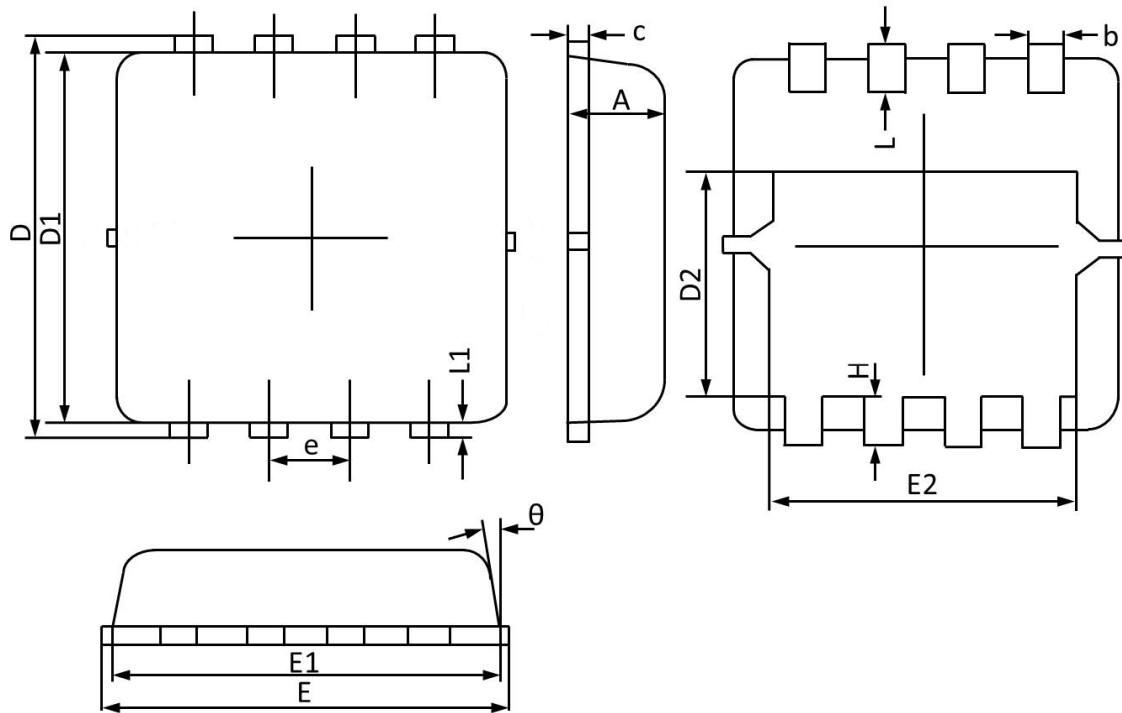
Fig.2 On-Resistance vs. G-S Voltage

Fig.3 Forward Characteristics of Reverse

Fig.4 Gate-Charge Characteristics

Fig.5 Normalized V_{GS(th)} vs. T_J

Fig.6 Normalized R_{DS(on)} vs. T_J

N-Channel Enhancement Mode MOSFET

Fig.7 Capacitance

Fig.8 Safe Operating Area

Fig.9 Normalized Maximum Transient Thermal Impedance

Fig.10 Switching Time Waveform

Fig.11 Unclamped Inductive Switching Waveform

N-Channel Enhancement Mode MOSFET
DFN3*3-8 EP1 Package Outline Data

Symbol	Dimensions (unit:mm)			Symbol	Dimensions (unit:mm)		
	Min	Typ	Max		Min	Typ	Max
A	0.70	0.75	0.85	E1	2.90	3.10	3.25
b	0.24	0.30	0.35	E2	2.35	2.50	2.60
c	0.10	0.17	0.25	e	0.65 BSC		
D	3.10	3.30	3.45	H	0.30	0.40	0.50
D1	2.90	3.05	3.20	L	0.30	0.40	0.50
D2	1.45	1.70	1.95	L1	--	0.13	--
E	3.05	3.25	3.40	θ	0°		14°