

## N-Channel Enhancement Mode MOSFET

### Features

- Low  $R_{ds(on)}$  for low conduction loss
- Reliable and Rugged
- ROHS Compliant & Halogen-Free

### Pin Description

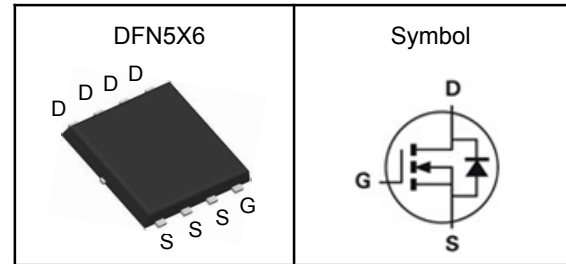

### Applications

- Power Management in Desktop Computer
- DC/DC Converters

$V_{DSS}$	30	V
$R_{DS(ON)-Typ}$	1.8	m $\Omega$
$I_D$	150	A

### Absolute Maximum Ratings ( $T_A=25^\circ\text{C}$ , Unless Otherwise Noted)

Symbol	Parameter	N-Channel	Unit
$V_{DSS}$	Drain-Source Voltage	30	V
$V_{GSS}$	Gate-Source Voltage	$\pm 20$	V
$T_J$	Maximum Junction Temperature	-55 to 150	$^\circ\text{C}$
$T_{STG}$	Storage Temperature Range	-55 to 150	$^\circ\text{C}$
$I_{DM}^{①}$	Pulse Drain Current Tested	$T_C=25^\circ\text{C}$	160
$I_D$	Continuous Drain Current	$T_C=25^\circ\text{C}$	150
		$T_A=25^\circ\text{C}$	28
$P_D$	Maximum Power Dissipation	$T_C=25^\circ\text{C}$	78
		$T_A=25^\circ\text{C}$	2.3
$E_{AS}^{②}$	Avalanche Energy, Single pulse $L=0.1\text{mH}$	372	mJ

### Thermal Characteristics

Symbol	Parameter	Rating	Unit
$R_{\theta JA}^{③}$	Thermal Resistance-Junction to Ambient (Max)	55	$^\circ\text{C}/\text{W}$
$R_{\theta JC}$	Thermal Resistance-Junction to Case	1.6	$^\circ\text{C}/\text{W}$

Note ① : Max. current is limited by bonding wire.

Note ② : UIS tested and pulse width are limited by maximum junction temperature  $150^\circ\text{C}$ .

Note ③ : Surface Mounted on  $1\text{in}^2$  FR-4 board with 1oz.



**N-Channel Enhancement Mode MOSFET**

**Electrical Characteristics** ( $T_J=25^{\circ}\text{C}$ , Unless Otherwise Noted)

Symbol	Parameter	Test Conditions	Min	Typ	Max	Unit
<b>Static Electrical Characteristics</b>						
$BV_{DSS}$	Drain-Source Breakdown Voltage	$V_{GS}=0V, I_D=250\mu A$	30	---	---	V
$I_{DSS}$	Zero Gate Voltage Drain Current	$V_{DS}=24V, V_{GS}=0V$	---	---	1	$\mu A$
$V_{GS(th)}$	Gate Threshold Voltage	$V_{DS}=V_{GS}, I_D=250\mu A$	1.3	---	2.5	V
$I_{GSS}$	Gate Leakage Current	$V_{GS}=\pm 20V, V_{DS}=0V$	---	---	$\pm 100$	nA
$R_{DS(on)}$	Drain-Source On-state Resistance	$V_{GS}=10V, I_D=20A$	---	1.8	2.3	m $\Omega$
		$V_{GS}=4.5V, I_D=12A$	---	2.2	3.0	
gfs	Forward Transconductance	$V_{DS}=5V, I_D=15A$	---	32	---	S
<b>Dynamic Characteristics<sup>⑤</sup></b>						
$C_{iss}$	Input Capacitance	$V_{GS}=0V, V_{DS}=15V, \text{Freq.}=1\text{MHz}$	---	2820	---	pF
$C_{oss}$	Output Capacitance		---	1910	---	
$C_{rss}$	Reverse Transfer Capacitance		---	140	---	
$T_{d(on)}$	Turn-on Delay Time	$V_{DD}=15V, R_L=15\Omega, I_{DS}=1A, V_{GEN}=10V, R_G=6\Omega$	---	15.5	---	nS
$T_r$	Turn-on Rise Time		---	11	---	
$T_{d(off)}$	Turn-off Delay Time		---	35	---	
$T_f$	Turn-off Fall Time		---	40	---	
$Q_g$	Total Gate Charge	$V_{DS}=15V, V_{GS}=4.5V, I_D=20A$	---	21.2	---	nC
$Q_{gs}$	Gate-Source Charge		---	4.3	---	
$Q_{gd}$	Gate-Drain Charge		---	8.3	---	
<b>Source-Drain Characteristics</b>						
$V_{SD}^{④}$	Diode Forward Voltage	$V_{GS}=0V, I_{SD}=20A, T_J=25^{\circ}\text{C}$	---	0.8	1.1	V
$t_{rr}$	Reverse Recovery Time	$I_{SD}=20A, di/dt=100A/\mu s, T_J=25^{\circ}\text{C}$	---	50	---	nS
$Q_{rr}$	Reverse Recovery Charge		---	45	---	nC

Note ④: Pulse test (pulse width 300us, duty cycle 2%).

Note ⑤: Guaranteed by design, not subject to production testing.



**N-Channel Enhancement Mode MOSFET**

**Typical Characteristics**

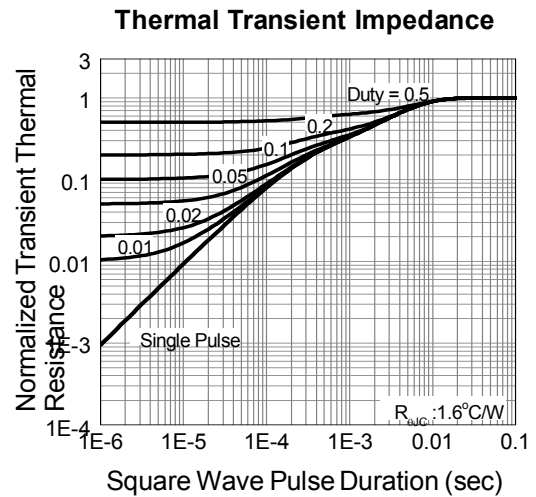
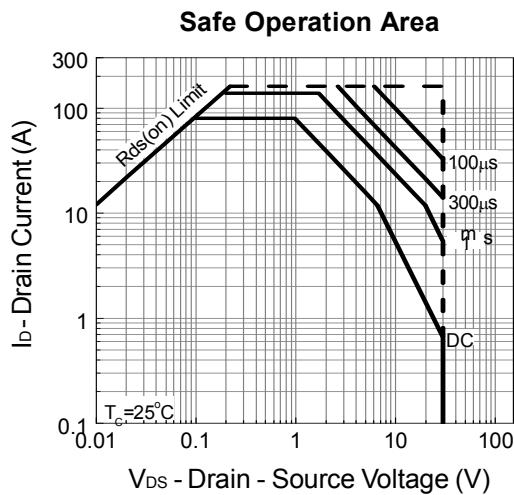
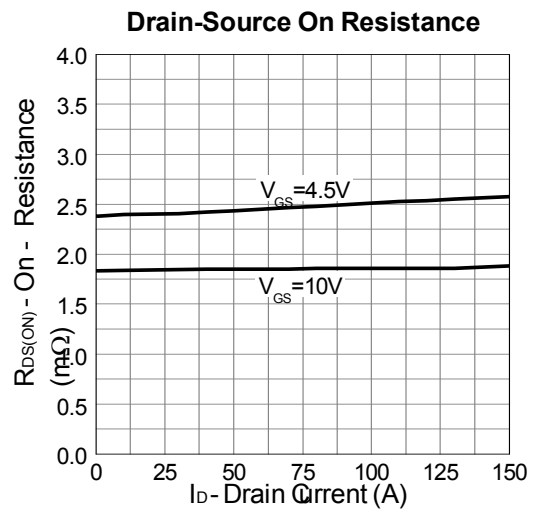
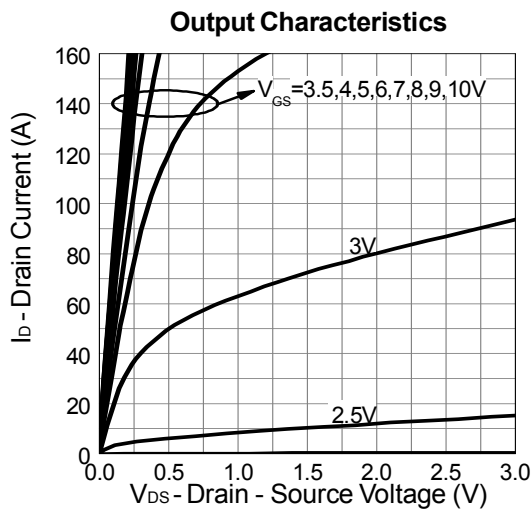
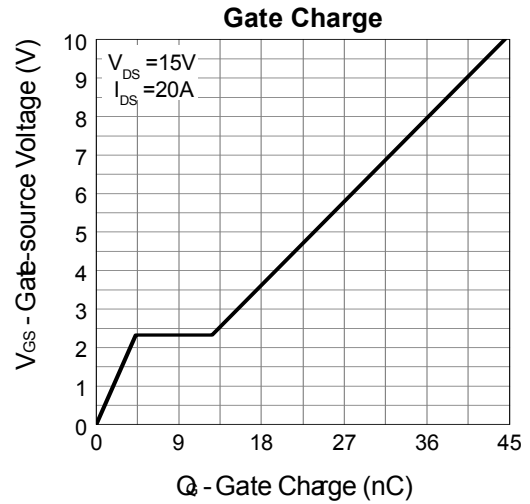
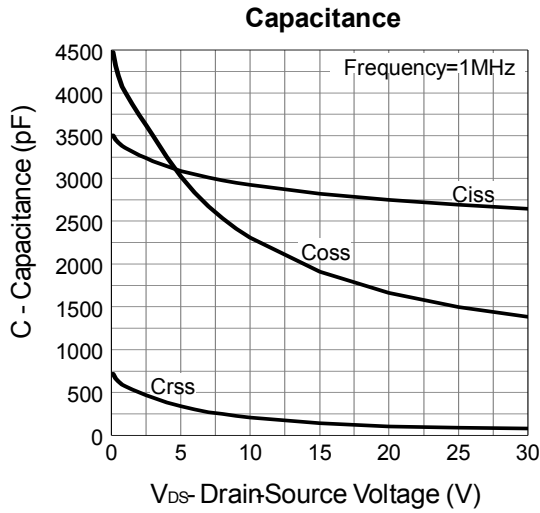

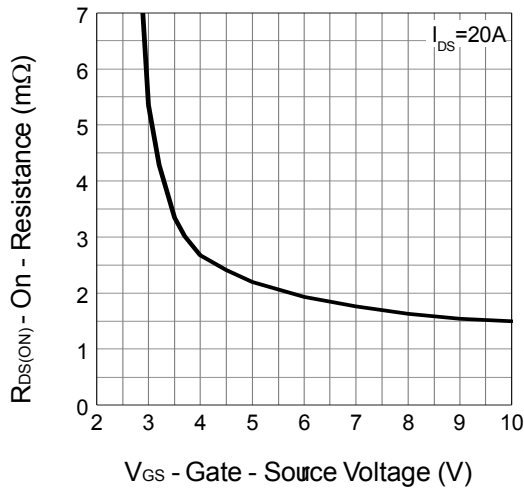
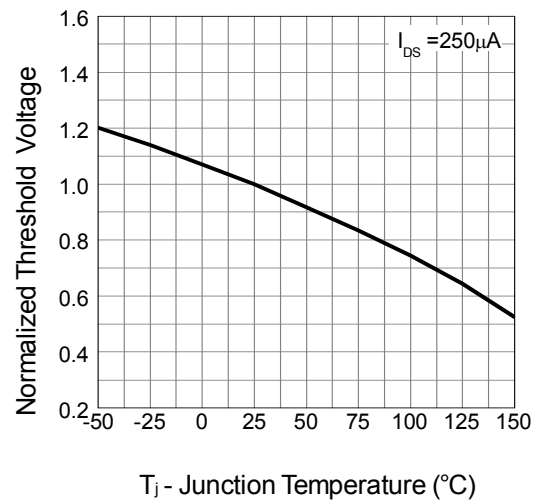
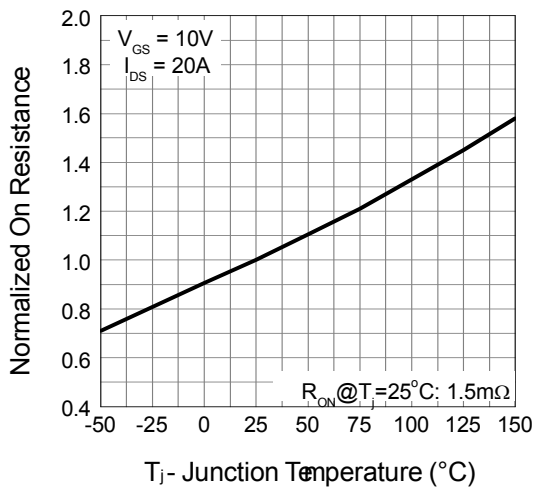
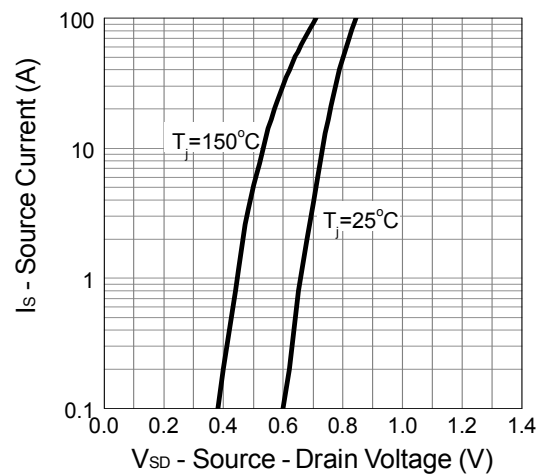
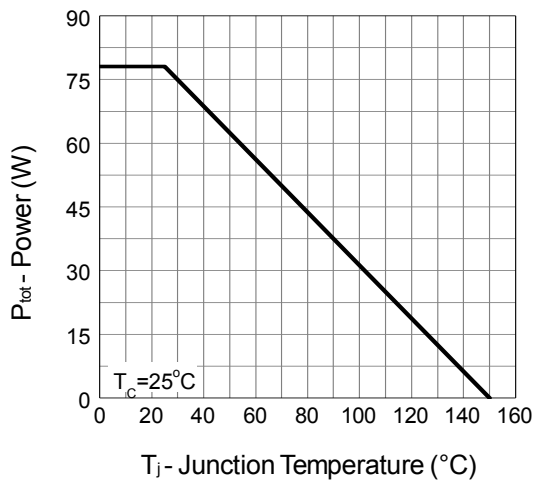
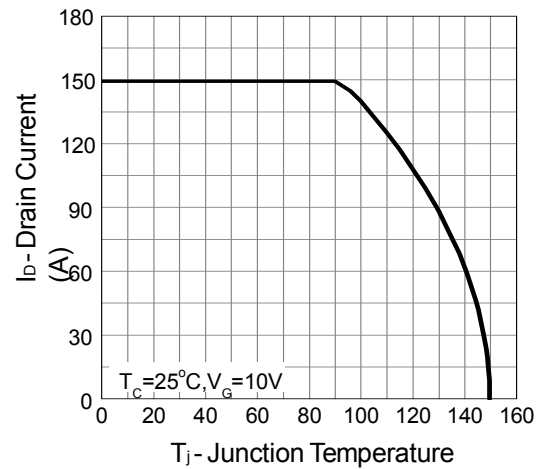
**N-Channel Enhancement Mode MOSFET**
**Gate-Source On Resistance**

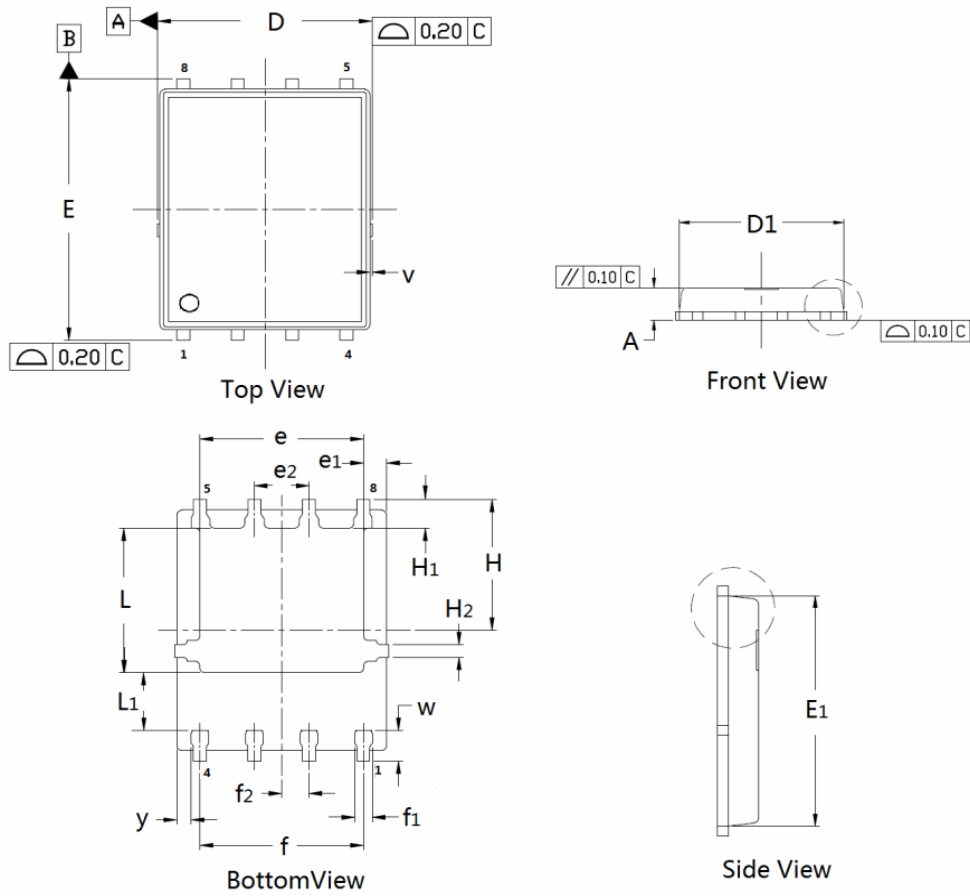
**Gate Threshold Voltage**

**Drain-Source On Resistance**

**Source-Drain Diode Forward**

**Power Dissipation**

**Drain Current**

**N-Channel Enhancement Mode MOSFET**
**DFN5×6 Package Outline Data**

**DIMENSIONS ( unit : mm )**

Symbol	Min	Typ	Max	Symbol	Min	Typ	Max
A	0.90	1.02	1.10	D	4.90	4.98	5.10
D <sub>1</sub>	4.80	4.89	5.10	E	5.90	6.11	6.25
E <sub>1</sub>	5.65	5.74	5.95	e	3.72	3.80	3.92
e <sub>1</sub>	--	0.5	--	e <sub>2</sub>	--	1.	--
f	--	3.8	--	f <sub>1</sub>	0.31	0.37	0.51
f <sub>2</sub>	--	0.6	--	H	--	3.	--
H <sub>1</sub>	0.59	0.63	0.79	H <sub>2</sub>	0.26	0.28	0.32
L	3.35	3.45	3.65	L <sub>1</sub>	--	1.	--
v	--	0.1	--	w	0.64	0.68	0.84
y	--	0.3	--		--		--