

N-Channel Enhancement Mode MOSFET

Features

- High Speed Power Switching
- Reliable and Rugged
- ROHS Compliant
- 100% Avalanche Tested

Applications

- Power Management in Desktop Computer
- DC/DC Converters

Pin Description

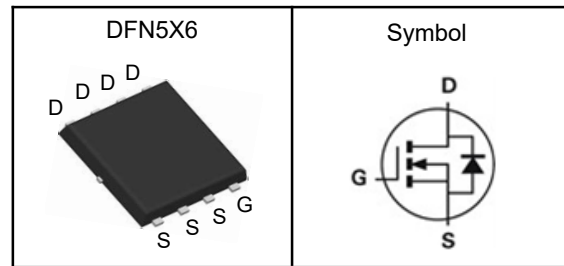

V_{DSS}	30	V
$R_{DS(ON)-Typ}$	0.6	m Ω
I_D	300	A

Absolute Maximum Ratings ($T_C=25^{\circ}C$, Unless Otherwise Noted)

Symbol	Parameter	Rating	Unit
V_{DSS}	Drain-Source Voltage	30	V
V_{GSS}	Gate-Source Voltage	± 20	V
T_J	Maximum Junction Temperature	-55 to 150	$^{\circ}C$
T_{STG}	Storage Temperature Range	-55 to 150	$^{\circ}C$
$I_{DM}^{①}$	Pulse Drain Current Tested	900	A
I_D	Continuous Drain Current	300	A
P_D	Maximum Power Dissipation	208	W
E_{AS}	Avalanche Energy, Single pulse	882	mJ

Thermal Characteristics

Symbol	Parameter	Rating	Unit
$R_{\theta JA}$	Thermal Resistance-Junction to Ambient	60	$^{\circ}C/W$
$R_{\theta JC}$	Thermal Resistance-Junction to Case	0.6	$^{\circ}C/W$

Note ① : Max. current is limited by bonding wire.

Note ② : UIS tested and pulse width are limited by maximum junction temperature 150 $^{\circ}C$.

Note ③ : Surface Mounted on 1in² FR-4 board with 1oz.

**N-Channel Enhancement Mode MOSFET****Electrical Characteristics** ($T_J=25^{\circ}\text{C}$, Unless Otherwise Noted)

Symbol	Parameter	Test Conditions	Min	Typ	Max	Unit
Static Electrical Characteristics						
BV_{DSS}	Drain-Source Breakdown Voltage	$V_{GS}=0V, I_D=250\mu A$	30	---	---	V
I_{DSS}	Zero Gate Voltage Drain Current	$V_{DS}=24V, V_{GS}=0V$	---	---	1	μA
$V_{GS(th)}$	Gate Threshold Voltage	$V_{DS}=V_{GS}, I_D=250\mu A$	1	---	2	V
I_{GSS}	Gate Leakage Current	$V_{GS}=\pm 20V, V_{DS}=0V$	---	---	± 100	nA
$R_{DS(on)}$	Drain-Source On-state Resistance	$V_{GS}=10V, I_D=30A$	---	0.6	0.7	$m\Omega$
		$V_{GS}=4.5V, I_D=20A$	---	0.9	1.1	$m\Omega$
Dynamic Characteristics ^⑤						
C_{iss}	Input Capacitance	$V_{DS}=15V, V_{GS}=0V, \text{Freq.}=1\text{MHz}$	---	5571	---	pF
C_{oss}	Output Capacitance		---	2050	---	
C_{riss}	Reverse Transfer Capacitance		---	236	---	
$T_{d(on)}$	Turn-on Delay Time	$V_{DS}=15V, V_{GS}=10V, I_D=30A, R_G=3.9\Omega$	---	12	---	nS
T_r	Turn-on Rise Time		---	89	---	
$T_{d(off)}$	Turn-off Delay Time		---	110	---	
T_f	Turn-off Fall Time		---	75	---	
Q_g	Total Gate Charge	$V_{DS}=15V, V_{GS}=10V, I_D=30A$	---	100	---	nC
Q_{gs}	Gate-Source Charge		---	17	---	
Q_{gd}	Gate-Drain Charge		---	16	---	
Source-Drain Characteristics						
V_{SD}	Diode Forward Voltage	$I_S=30A, V_{GS}=0V$	---	---	1.3	V
t_{rr}	Reverse Recovery Time	$I_F=30A, di_F/dt=100A/\mu s$	---	51	---	nS
Q_{rr}	Reverse Recovery Charge		---	42	---	nC

Note ④: Pulse test (pulse width $\leq 300\mu s$, duty cycle $\leq 2\%$).

Note ⑤: Guaranteed by design, not subject to production testing.



N-Channel Enhancement Mode MOSFET

Typical Characteristics

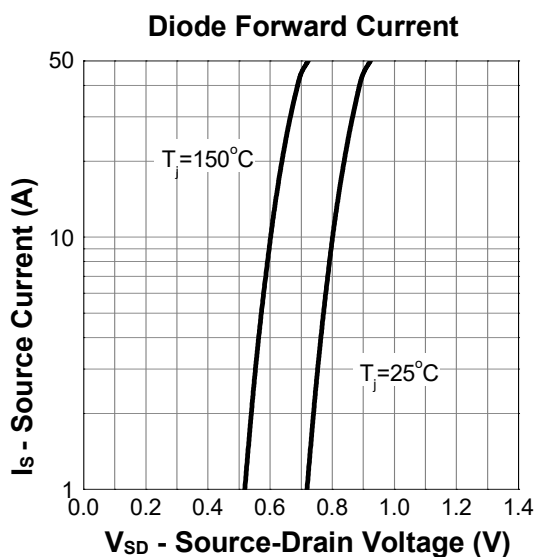
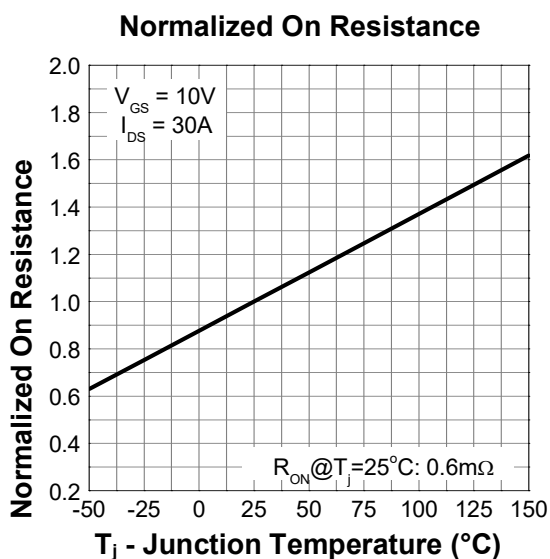
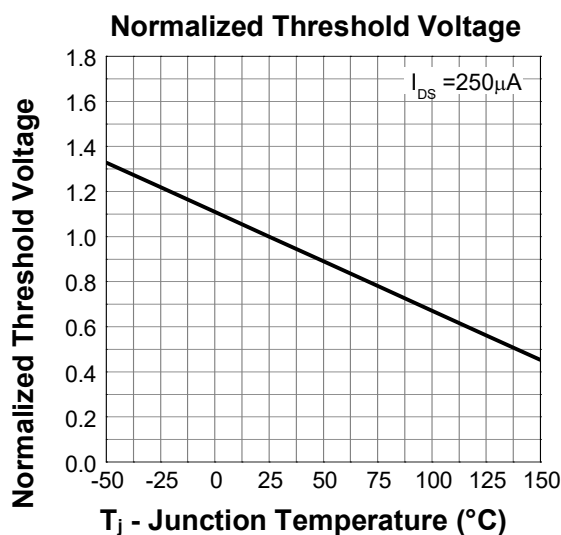
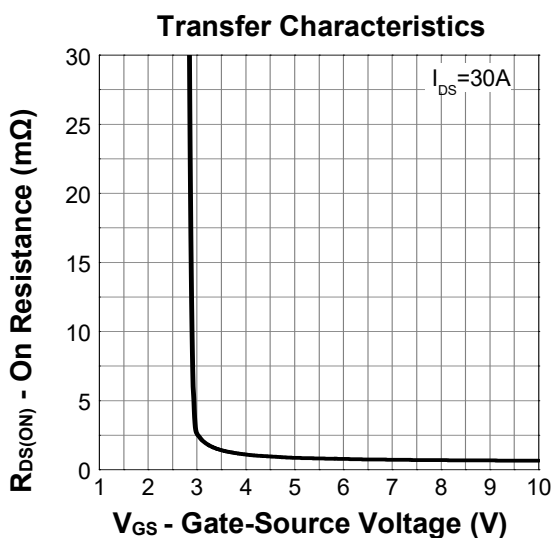
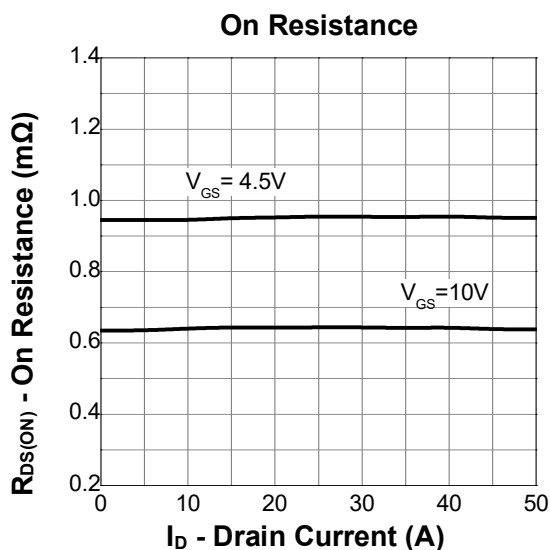
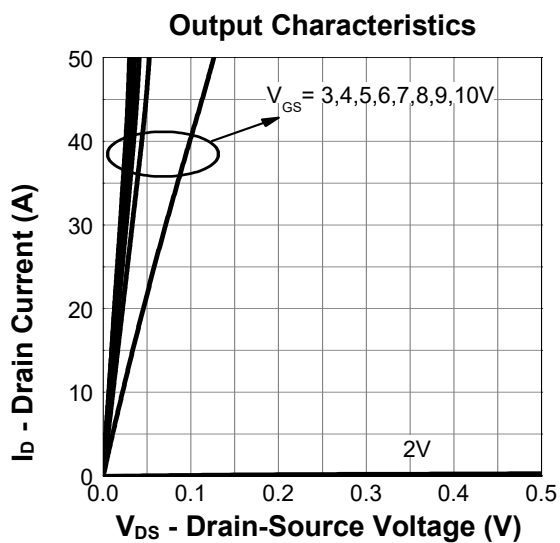



N-Channel Enhancement Mode MOSFET

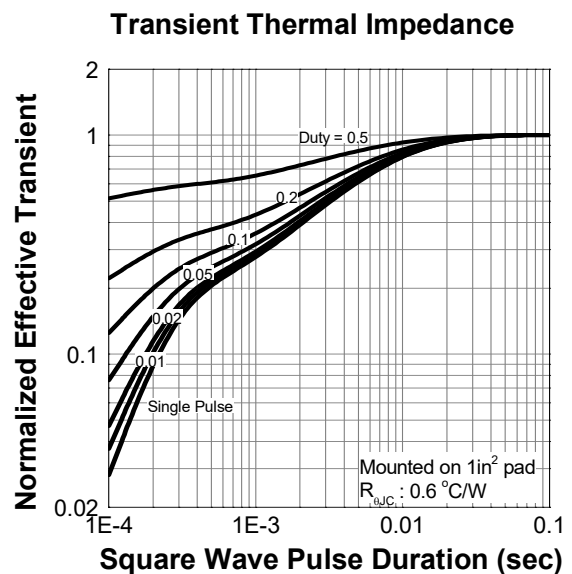
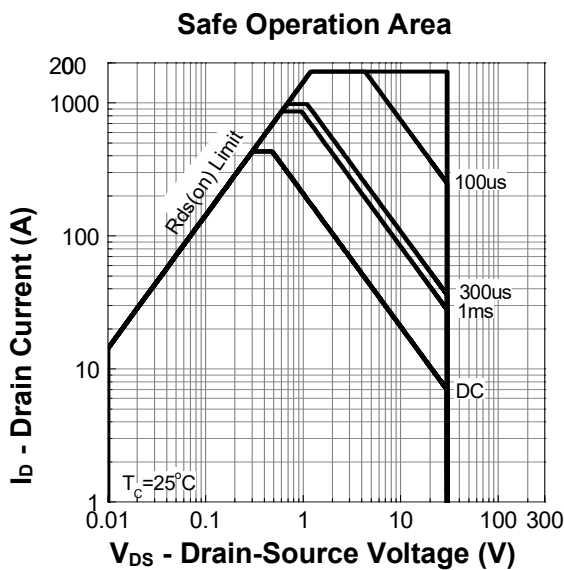
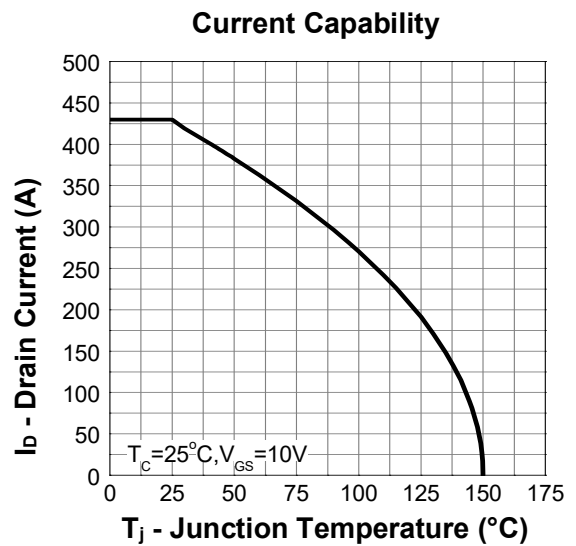
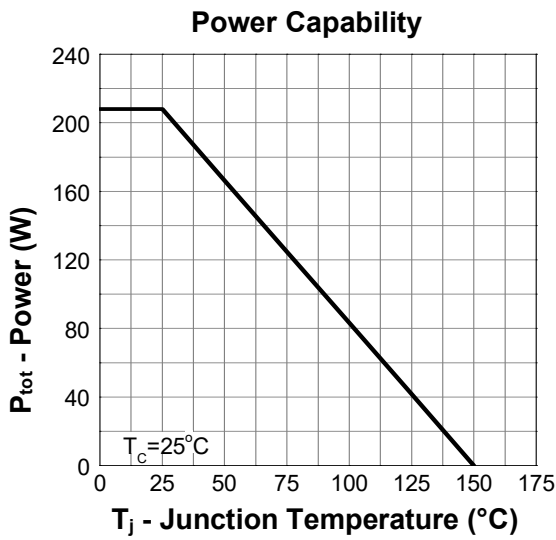
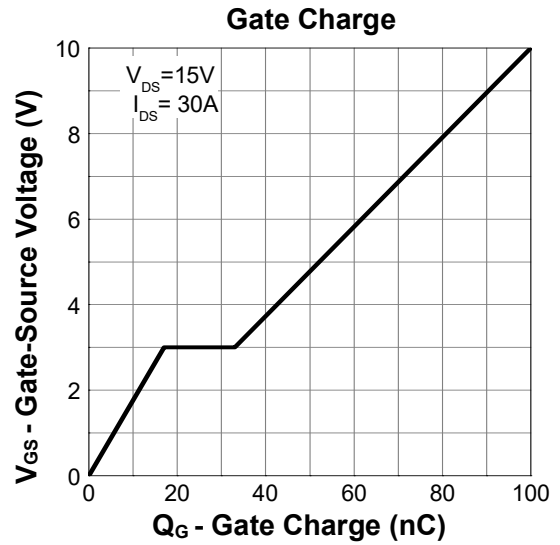
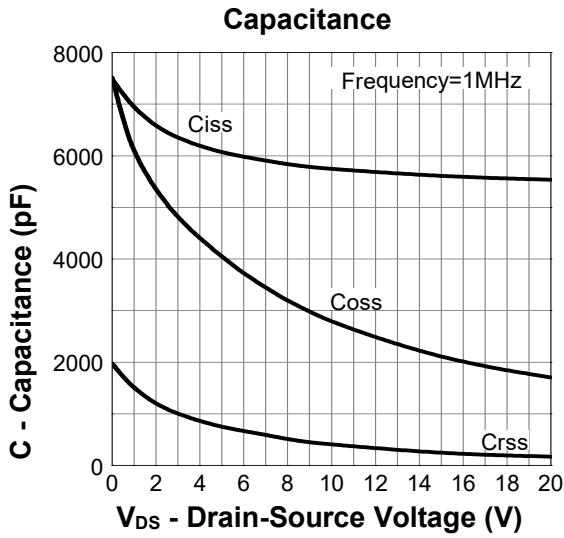

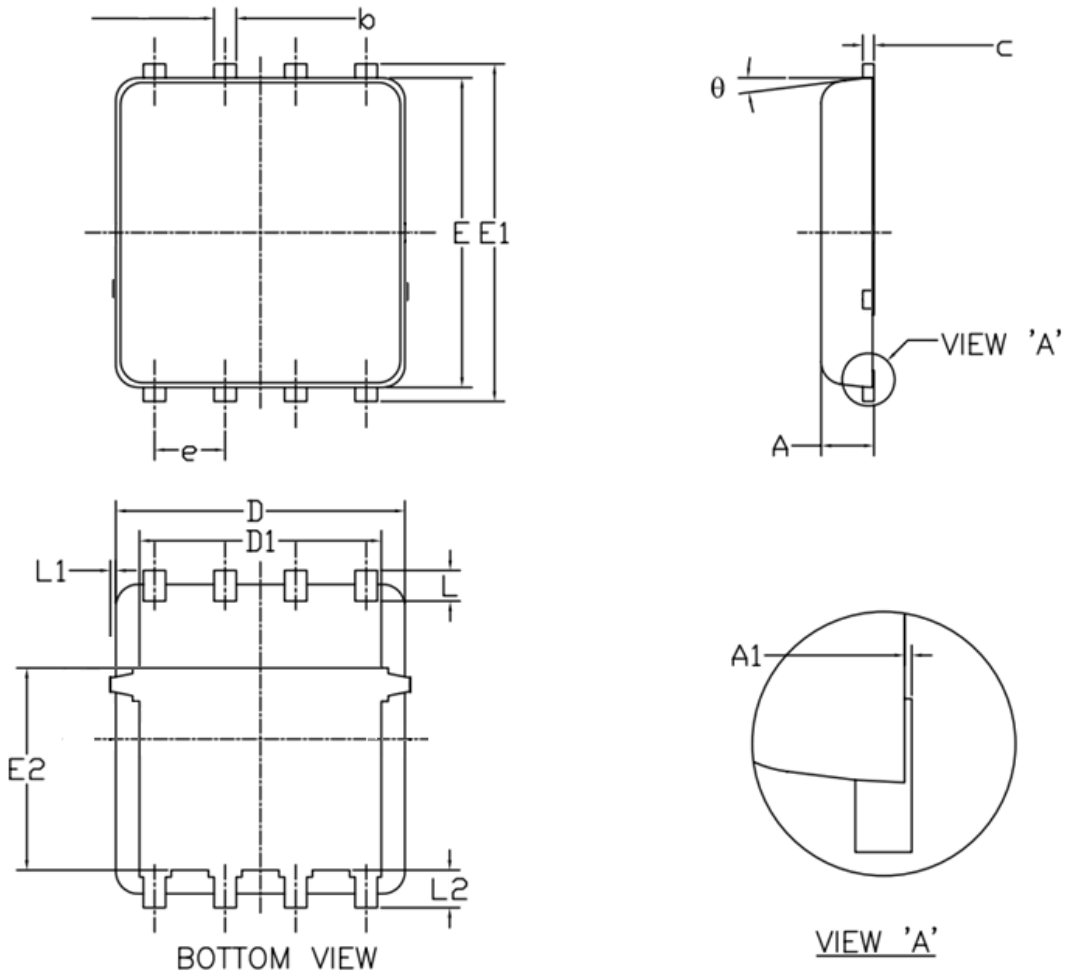
N-Channel Enhancement Mode MOSFET
DFN5X6-8L Package Outline Dimensions

Symbol	Dimensions (unit:mm)			Symbol	Dimensions (unit:mm)		
	Min	Typ	Max		Min	Typ	Max
A	0.90	1.00	1.20	E1	5.90	6.10	6.35
A1	0.00	--	0.05	E2	3.38	3.58	3.92
b	0.30	0.40	0.51	e	1.27 BSC		
c	0.20	0.25	0.33	L	0.51	0.61	0.71
D	4.80	4.90	5.40	L1	--	--	0.15
D1	3.61	4.00	4.25	L2	0.41	0.51	0.61
E	5.65	5.80	6.06	θ	0°	--	12°