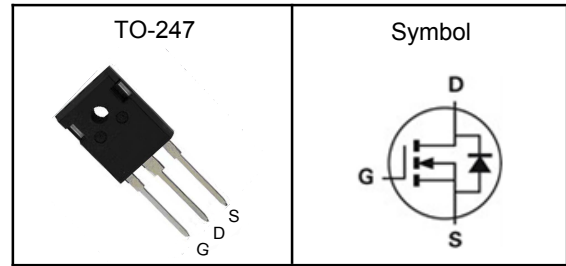

N-Channel Enhancement Mode MOSFET
Features

- Low $R_{ds(on)}$ for low conduction loss
- Reliable and Rugged
- ROHS Compliant & Halogen-Free

Pin Description

Applications

- Power Management in Desktop Computer
- DC/DC Converters

V_{DSS}	250	V
$R_{DS(ON)-Typ}$	16	$m\Omega$
I_D	80	A

Absolute Maximum Ratings ($T_J=25^\circ\text{C}$, Unless Otherwise Noted)

Symbol	Parameter	Rating	Unit
V_{DSS}	Drain-Source Voltage	250	V
V_{GSS}	Gate-Source Voltage	± 20	V
T_J	Maximum Junction Temperature	-55 to 150	$^\circ\text{C}$
T_{STG}	Storage Temperature Range	-55 to 150	$^\circ\text{C}$
E_{AS}	Single Pulse Avalanche Energy ³	1200	mJ
$I_{DM}^{①}$	300 μs Pulse Drain Current Tested	320	A
I_D	Continuous Drain Current	$T_C=25^\circ\text{C}$	A
P_D	Maximum Power Dissipation	$T_C=25^\circ\text{C}$	W

Thermal Characteristics

Symbol	Parameter	Rating	Unit
$R_{\theta JC}$	Thermal Resistance Junction-Case ¹	0.49	$^\circ\text{C}/\text{W}$

Note ① : Max. current is limited by bonding wire.

Note ② : UIS tested and pulse width are limited by maximum junction temperature 150°C .

Note ③ : Surface Mounted on 1in^2 FR-4 board with 1oz.



N-Channel Enhancement Mode MOSFET

Electrical Characteristics ($T_J=25^{\circ}\text{C}$, Unless Otherwise Noted)

Symbol	Parameter	Test Conditions	Min	Typ	Max	Unit
Static Electrical Characteristics						
BV_{DSS}	Drain-Source Breakdown Voltage	$V_{GS}=0V, I_D=1mA$	250	---	---	V
I_{DSS}	Zero Gate Voltage Drain Current	$V_{DS}=250V, V_{GS}=0V$	---	---	1	μA
$V_{GS(th)}$	Gate Threshold Voltage	$V_{DS}=V_{GS}, I_D=250\mu A$	2.5	---	4.5	V
I_{GSS}	Gate Leakage Current	$V_{GS}=\pm 20V, V_{DS}=0V$	---	---	± 100	nA
$R_{DS(ON)}$	Drain-Source On-state Resistance	$V_{GS}=10V, I_D=40A$	---	16	19	$m\Omega$
Dynamic Characteristics ^⑤						
C_{iss}	Input Capacitance	$V_{GS}=0V,$ $V_{DS}=125V,$ $Freq.=1MHz$	---	5535	---	pF
C_{oss}	Output Capacitance		---	320	---	
C_{rss}	Reverse Transfer Capacitance		---	12	---	
$T_{d(on)}$	Turn-on Delay Time	$V_{DD}=125V, I_D=40A$ $V_{GS}=10V, R_G=4.7\Omega$	---	18	---	nS
T_r	Turn-on Rise Time		---	26	---	
$T_{d(off)}$	Turn-off Delay Time		---	48	---	
T_f	Turn-off Fall Time		---	11	---	
Q_g	Total Gate Charge	$V_{DS}=125V,$ $V_{GS}=10V,$ $I_D=40A$	---	78	---	nC
Q_{gs}	Gate-Source Charge		---	23	---	
Q_{gd}	Gate-Drain Charge		---	18	---	
Source-Drain Characteristics ($T_J=25^{\circ}\text{C}$)						
$V_{SD}^{④}$	Diode Forward Voltage	$I_S=40A, V_{GS}=0V$	---	---	1.2	V
t_{rr}	Reverse Recovery Time	$I_F=40A,$	---	146	---	nS
Q_{rr}	Reverse Recovery Charge	$di/dt=100A/\mu s, T_J=25^{\circ}\text{C}$	---	560	---	nC

Note ④ : Pulse test (pulse width $\leq 300\mu s$, duty cycles $\leq 2\%$).

Note ⑤ : Guaranteed by design, not subject to production testing.

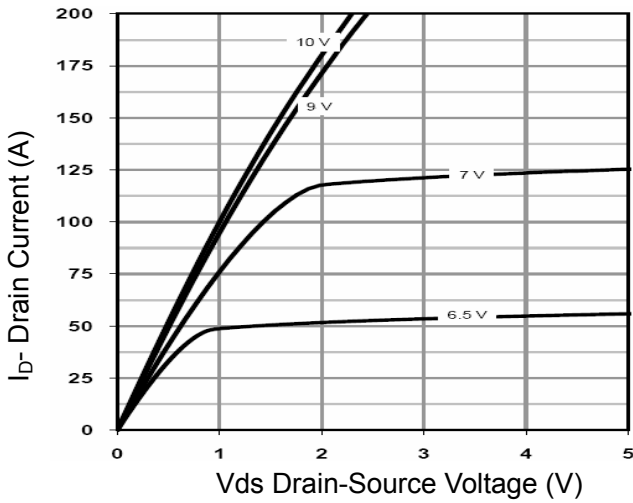
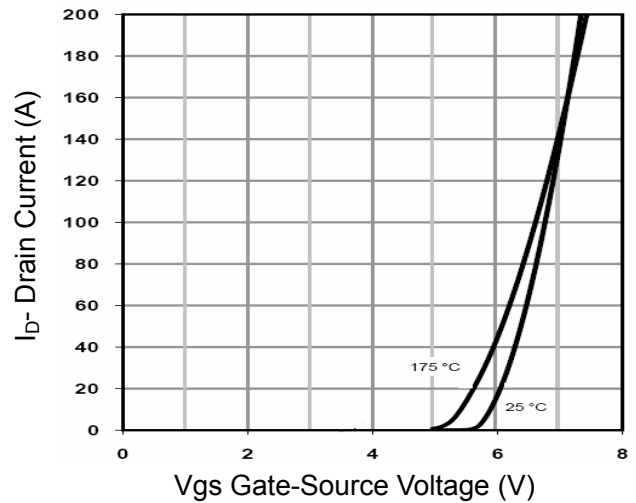
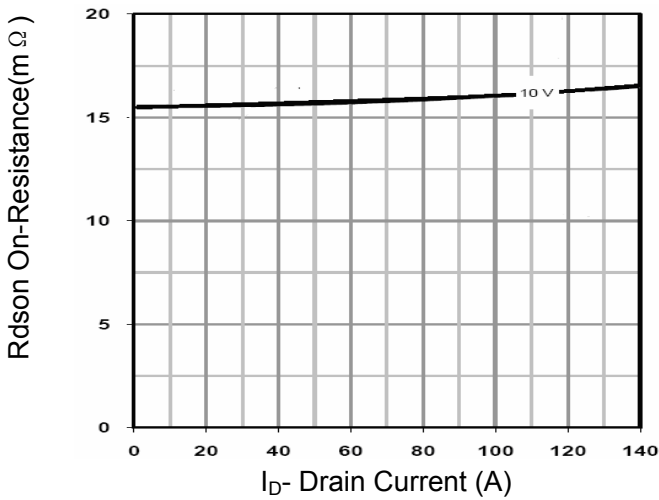
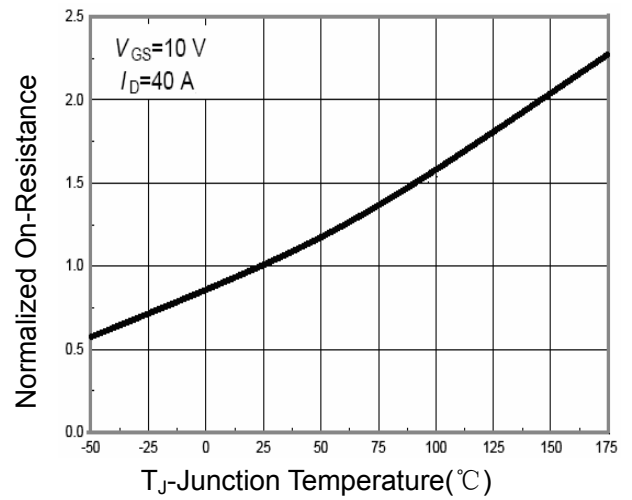
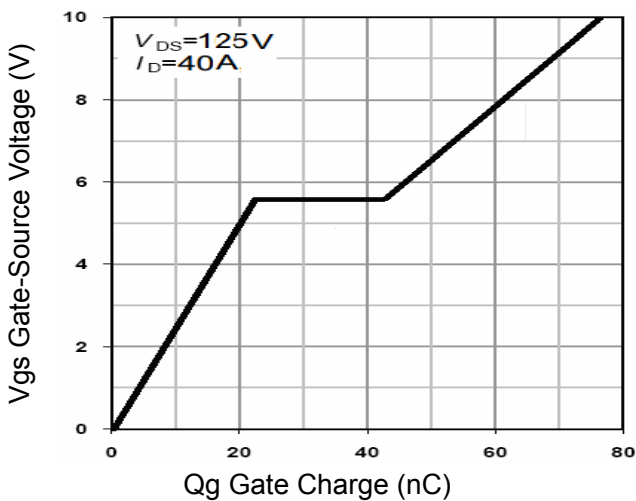
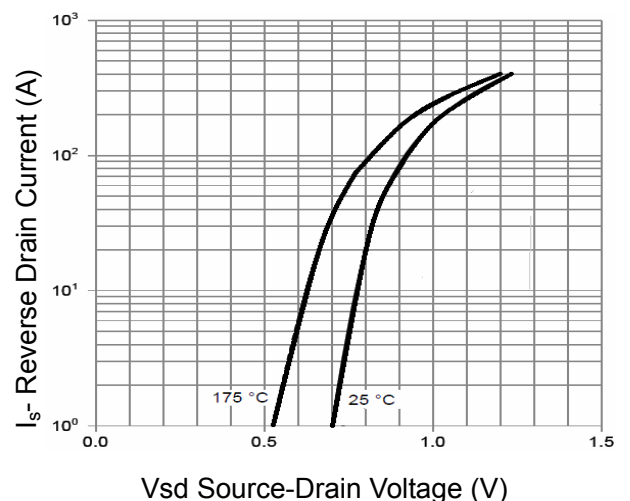
N-Channel Enhancement Mode MOSFET
Typical Characteristics

Figure 1 Output Characteristics

Figure 2 Transfer Characteristics

Figure 3 Rdson- Drain Current

Figure 4 Rdson-Junction Temperature

Figure 5 Gate Charge

Figure 6 Source- Drain Diode Forward

N-Channel Enhancement Mode MOSFET

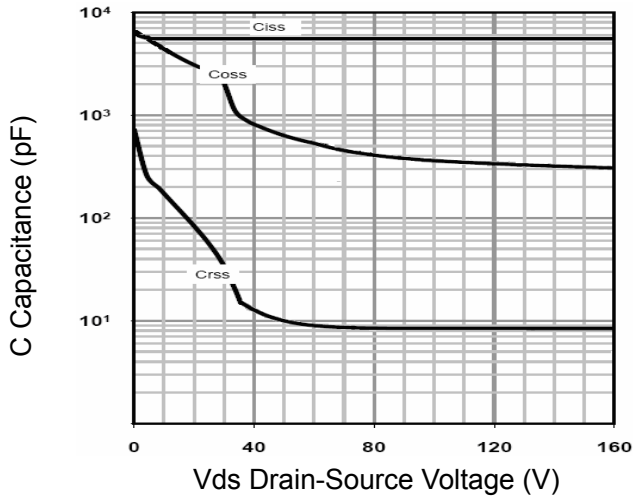

Figure 7 Capacitance vs Vds

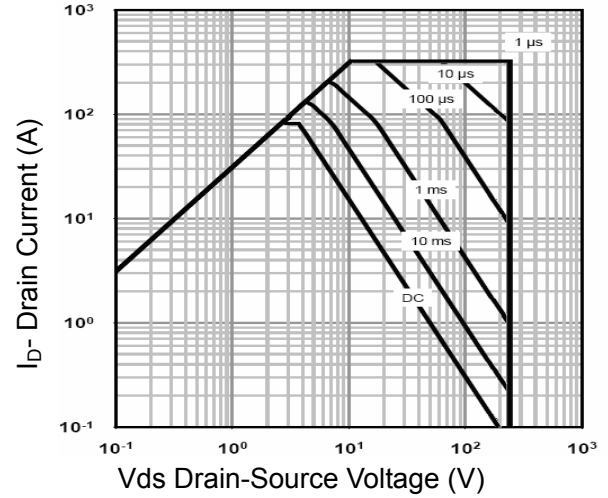

Figure 8 Safe Operation Area

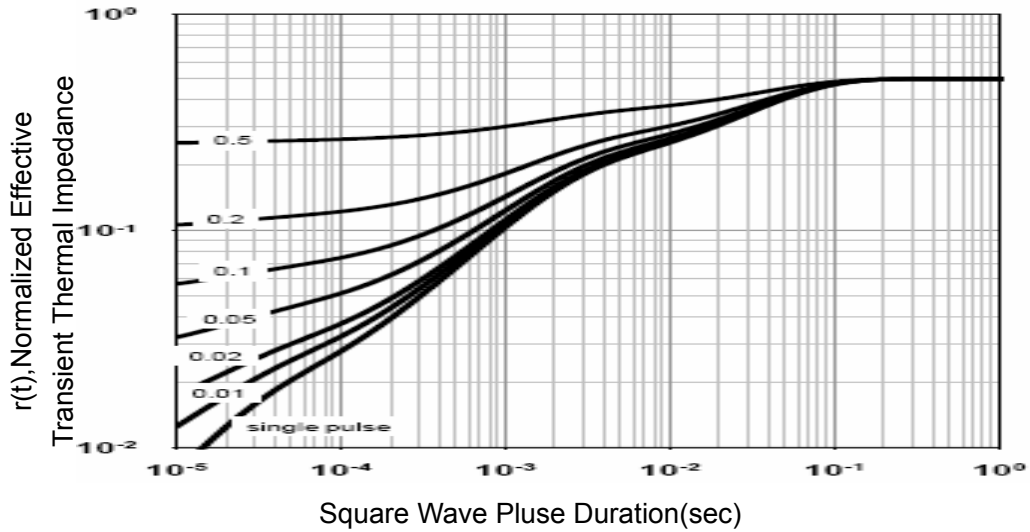
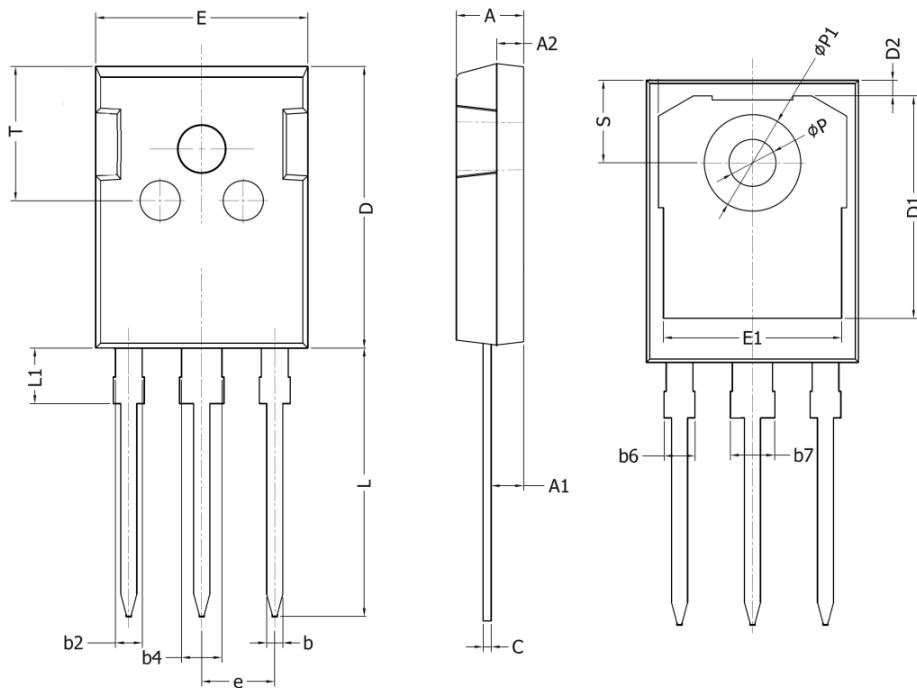

Figure 9 Normalized Maximum Transient Thermal Impedance

N-Channel Enhancement Mode MOSFET
TO-247 Package Outline Dimensions

Symbol	Dimensions In Millimeters	
	Min.	Max.
A	4.90	5.20
A1	2.31	2.51
A2	1.9	2.1
b	1.16	1.26
b2	1.96	2.06
b4	2.96	3.06
b6	-	2.25
b7	-	3.25
C	0.59	0.66
D	20.90	21.20
D1	16.25	16.85
D2	1.05	1.35
E	15.75	16.10
E1	13.00	13.60
e	5.436 BSC	
L	19.80	20.20
L1	-	4.30
P	3.40	3.60
P1	7.00	7.40
S	6.05	6.25
T	9.80	10.20