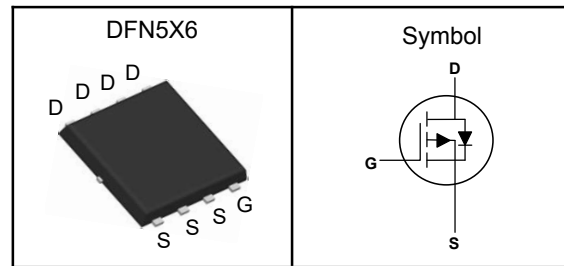

P-Channel Enhancement Mode MOSFET
Features

- Fast switching speed
- ROHS Compliant & Halogen-Free
- 100% UIS and Rg Tested

Applications

- Motor drivers
- DC - DC Converter

Pin Description

V_{DSS}	-200	V
$R_{DS(ON)-Typ}$	125	m Ω
I_D	-19	A

Absolute Maximum Ratings ($T_J=25^\circ\text{C}$, Unless Otherwise Noted)

Symbol	Parameter	Rating	Unit
V_{DSS}	Drain-Source Voltage	-200	V
V_{GSS}	Gate-Source Voltage	± 20	V
T_J	Maximum Junction Temperature	-55 to 150	$^\circ\text{C}$
T_{STG}	Storage Temperature Range	-55 to 150	$^\circ\text{C}$
$I_{DM}^{①}$	Pulse Drain Current Tested	-76	A
I_D	Continuous Drain Current	$T_C=25^\circ\text{C}$	A
P_D	Maximum Power Dissipation	$T_C=25^\circ\text{C}$	W
E_{AS}	Avalanche Energy, Single pulse	100	mJ

Thermal Characteristics

Symbol	Parameter	Rating	Unit
$R_{\theta JA}$	Thermal Resistance-Junction to Ambient	40	$^\circ\text{C}/\text{W}$
$R_{\theta JC}$	Thermal Resistance-Junction to Case	1.0	$^\circ\text{C}/\text{W}$

Note ① : Max. current is limited by bonding wire.

Note ② : UIS tested and pulse width are limited by maximum junction temperature 150°C .

Note ③ : Surface Mounted on 1in^2 FR-4 board with 1oz.



P-Channel Enhancement Mode MOSFET

Electrical Characteristics ($T_J=25^{\circ}\text{C}$, Unless Otherwise Noted)

Symbol	Parameter	Test Conditions	Min	Typ	Max	Unit
Static Electrical Characteristics						
BV_{DSS}	Drain-Source Breakdown Voltage	$V_{GS}=0V, I_D=-250\mu A$	-200	---	---	V
I_{DSS}	Zero Gate Voltage Drain Current	$V_{DS}=-160V, V_{GS}=0V$	---	---	-1	μA
$V_{GS(th)}$	Gate Threshold Voltage	$V_{DS}=V_{GS}, I_D=-250\mu A$	-2.0	---	-4.0	V
I_{GSS}	Gate Leakage Current	$V_{GS}=\pm 20V, V_{DS}=0V$	---	---	± 100	nA
$R_{DS(on)}$	Drain-Source On-state Resistance	$V_{GS}=-10V, I_D=-3A$	---	125	165	m Ω
Dynamic Characteristics^⑤						
C_{iss}	Input Capacitance	$V_{GS}=0V,$ $V_{DS}=-100V,$ Freq.=1MHz	---	2484	---	pF
C_{oss}	Output Capacitance		---	127	---	
C_{rss}	Reverse Transfer Capacitance		---	71	---	
$T_{d(on)}$	Turn-on Delay Time	$V_{GS}=-10V, V_{DS}=-75V,$ $I_D=-3A, R_G=6\Omega$	---	25	---	nS
T_r	Turn-on Rise Time		---	22	---	
$T_{d(off)}$	Turn-off Delay Time		---	68	---	
T_f	Turn-off Fall Time		---	37	---	
Q_g	Total Gate Charge	$V_{GS}=-10V, V_{DS}=-75V,$ $I_D=-3A$	---	48	---	nC
Q_{gs}	Gate-Source Charge		---	11	---	
Q_{gd}	Gate-Drain Charge		---	14	---	
Source-Drain Characteristics						
$V_{SD}^{④}$	Diode Forward Voltage	$I_S=-3A, V_{GS}=0V$	---	---	-1.2	V
t_{rr}	Reverse Recovery Time	$I_F=-3A, di_F/dt=100A/\mu s$	---	52	---	nS
Q_{rr}	Reverse Recovery Charge		---	126	---	nC

Note ④: Pulse test (pulse width $\leq 300\mu s$, duty cycle $\leq 2\%$).

Note ⑤: Guaranteed by design, not subject to production testing.



P-Channel Enhancement Mode MOSFET

Typical Characteristics

Typical Output Characteristics

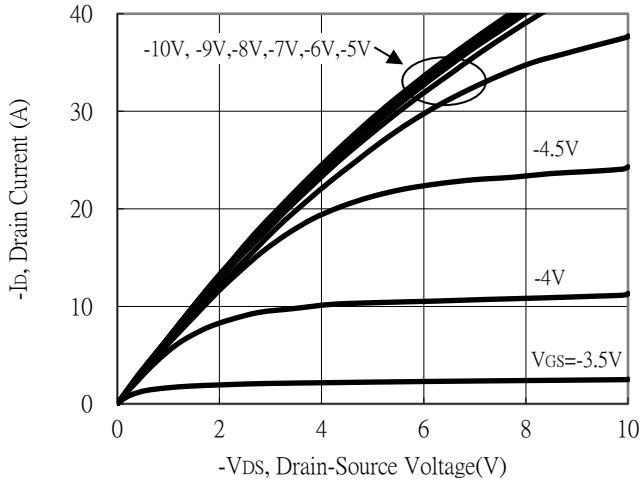

Static Drain-Source On-State Resistance vs Gate-Source Voltage

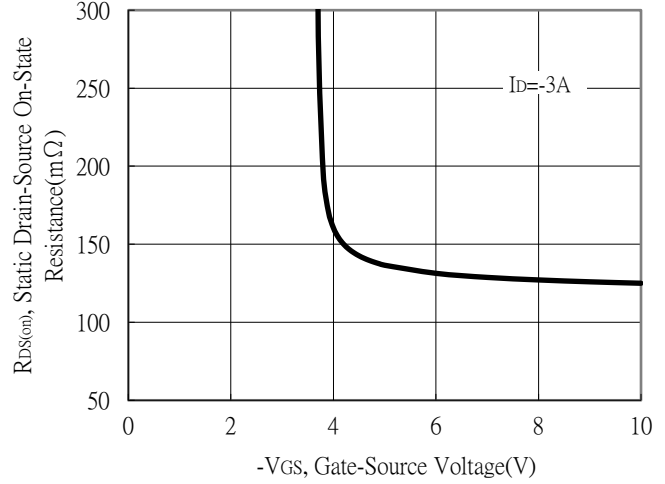

Static Drain-Source On-State resistance vs Drain Current

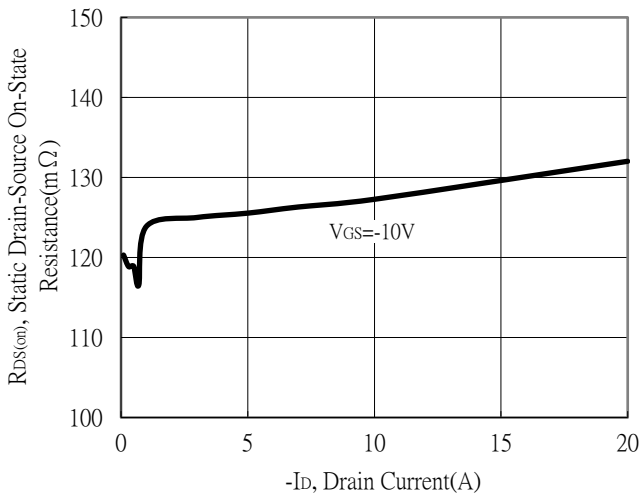

Drain-Source On-State Resistance vs Junction Temperature

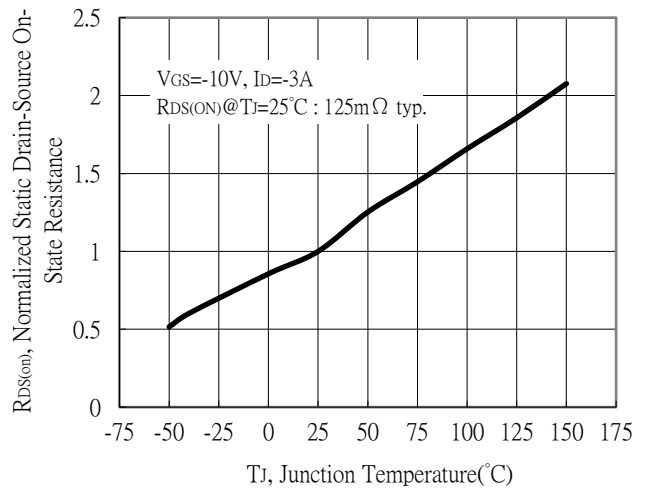

Body Diode Current vs Source-Drain Voltage

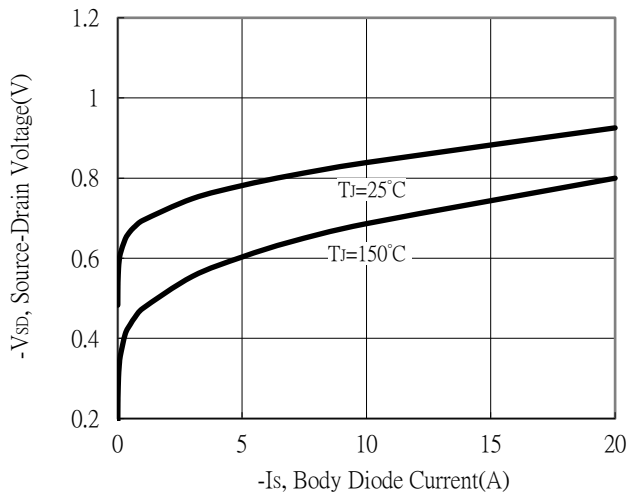

Breakdown Voltage vs Ambient Temperature

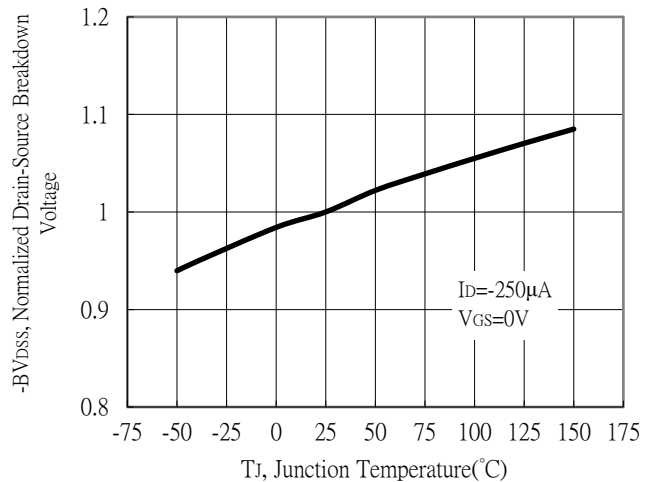

Drain-Source On-State Resistance vs Junction Temperature



P-Channel Enhancement Mode MOSFET

Capacitance vs Drain-to-Source Voltage

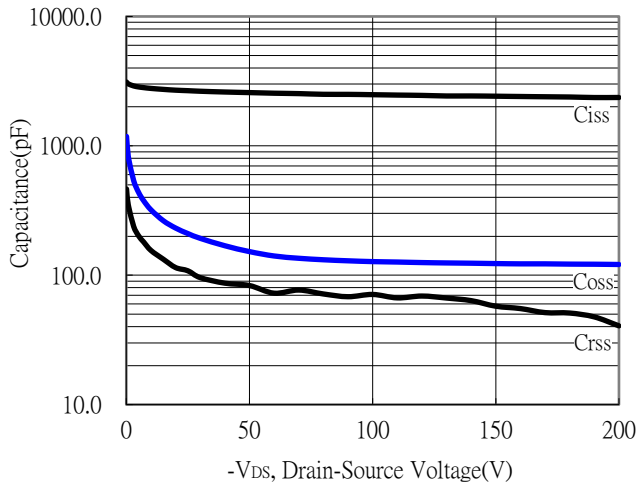

Gate Charge Characteristics

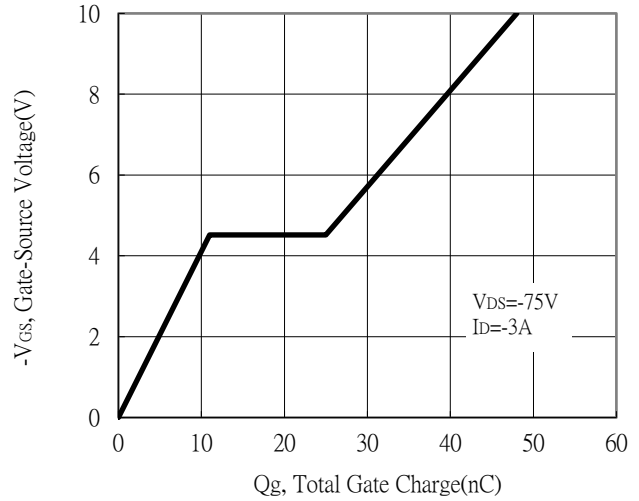

Maximum Safe Operating Area

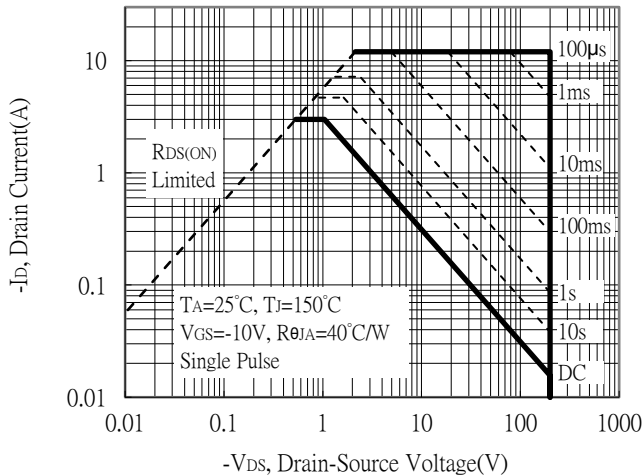

Maximum Drain Current vs Junction Temperature

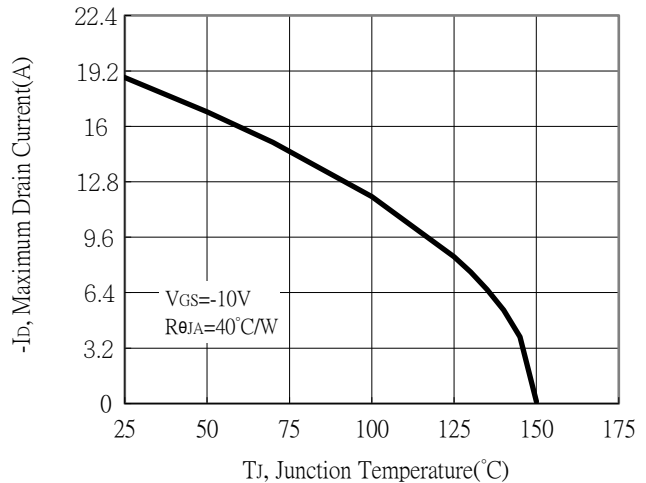

Transient Thermal Response Curves

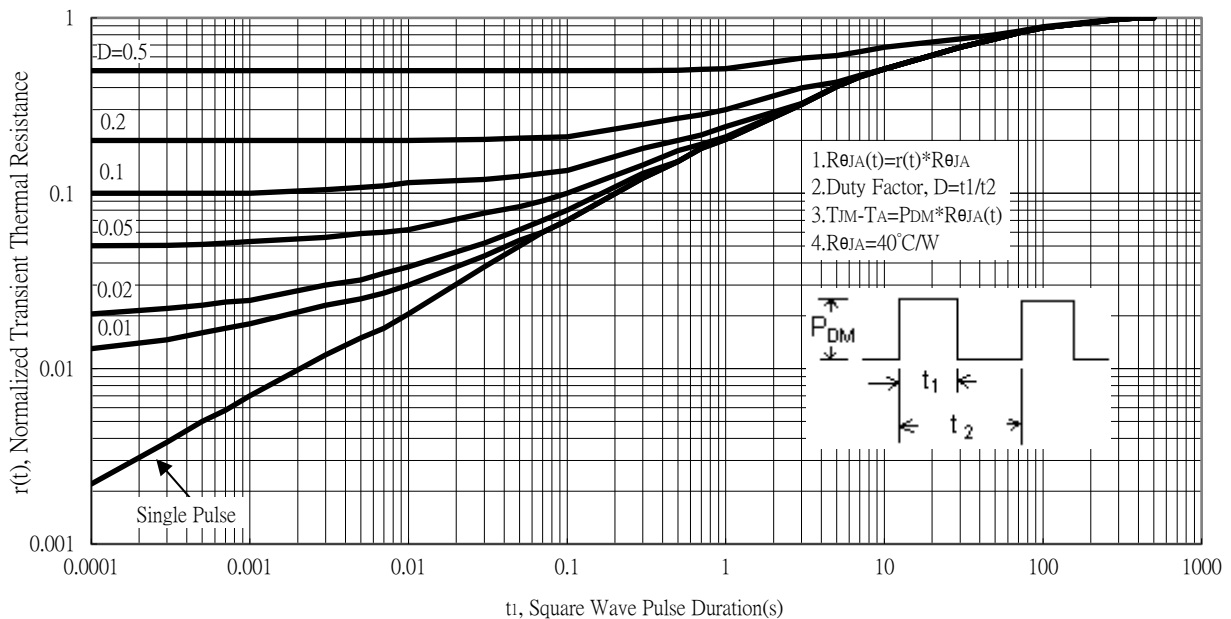

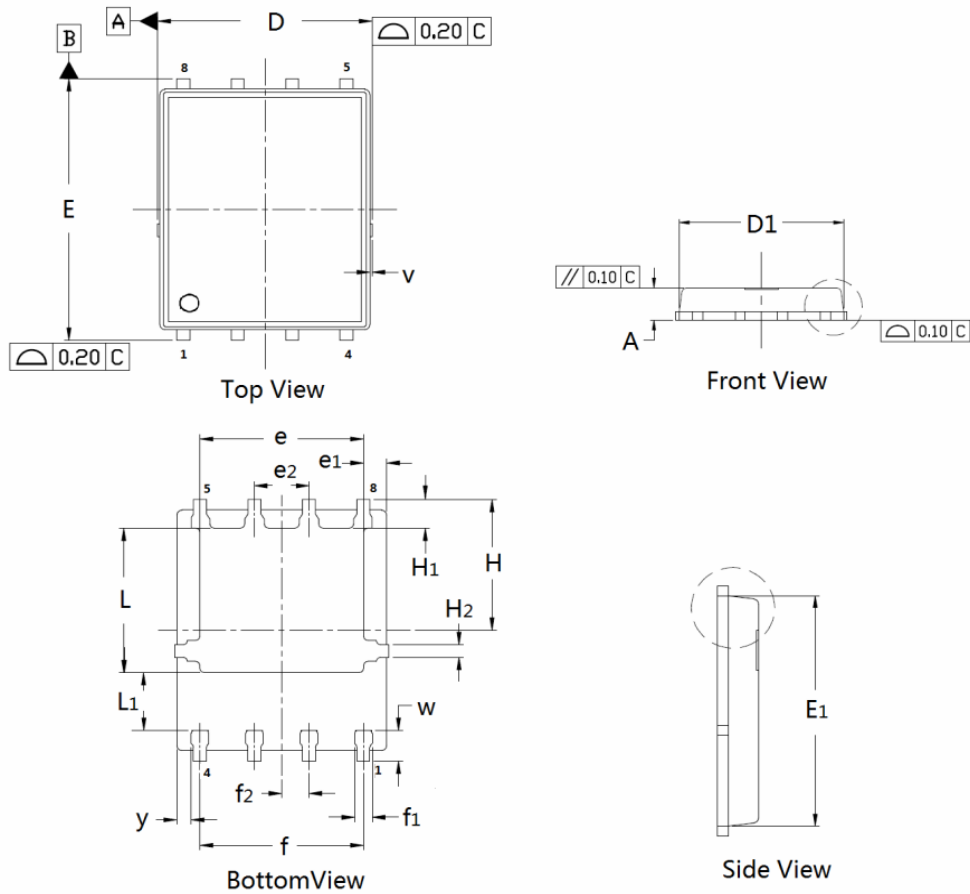
P-Channel Enhancement Mode MOSFET
DFN5×6 Package Outline Data

DIMENSIONS (unit : mm)

Symbol	Min	Typ	Max	Symbol	Min	Typ	Max
A	0.90	1.02	1.10	D	4.90	4.98	5.10
D ₁	4.80	4.89	5.10	E	5.90	6.11	6.25
E ₁	5.65	5.74	5.95	e	3.72	3.80	3.92
e ₁	--	0.5	--	e ₂	--	1.	--
f	--	3.8	--	f ₁	0.31	0.37	0.51
f ₂	--	0.6	--	H	--	3.	--
H ₁	0.59	0.63	0.79	H ₂	0.26	0.28	0.32
L	3.35	3.45	3.65	L ₁	--	1.	--
v	--	0.1	--	w	0.64	0.68	0.84
y	--	0.3	--				