

# N-Channel Enhancement Mode MOSFET

## Features

- High Speed Power Switching
- Reliable and Rugged
- ROHS Compliant
- 100% Avalanche Tested

## Applications

- Power Management in Desktop Computer
- DC/DC Converters

## Pin Description

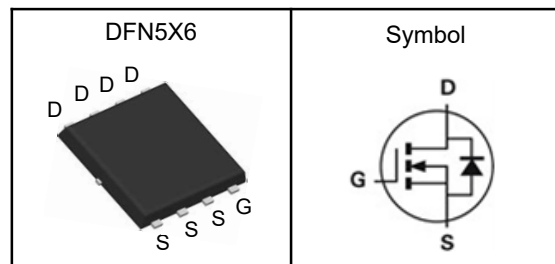

$V_{DSS}$	200	V
$R_{DS(ON)-Typ}$	70	m $\Omega$
$I_D$	18	A

## Absolute Maximum Ratings ( $T_C=25^{\circ}C$ , Unless Otherwise Noted)

Symbol	Parameter	N-Channel	Unit
$V_{DSS}$	Drain-Source Voltage	200	V
$V_{GSS}$	Gate-Source Voltage	$\pm 20$	V
$T_J$	Maximum Junction Temperature	-55 to 150	$^{\circ}C$
$T_{STG}$	Storage Temperature Range	-55 to 150	$^{\circ}C$
$I_{DM}^{①}$	Pulse Drain Current Tested	72	A
$I_D$	Continuous Drain Current	18	A
$P_D$	Maximum Power Dissipation	105	W
$E_{AS}$	Avalanche Energy, Single pulse	180	mJ

## Thermal Characteristics

Symbol	Parameter	Rating	Unit
$R_{\theta JA}$	Thermal Resistance-Junction to Ambient	65	$^{\circ}C/W$
$R_{\theta JC}$	Thermal Resistance-Junction to Case	1.2	$^{\circ}C/W$

Note ① : Max. current is limited by bonding wire.

Note ② : UIS tested and pulse width are limited by maximum junction temperature 150 $^{\circ}C$ .

Note ③ : Surface Mounted on 1in<sup>2</sup> FR-4 board with 1oz.

**N-Channel Enhancement Mode MOSFET****Electrical Characteristics** ( $T_J=25^{\circ}\text{C}$ , Unless Otherwise Noted)

Symbol	Parameter	Test Conditions	Min	Typ	Max	Unit
<b>Static Electrical Characteristics</b>						
$BV_{DSS}$	Drain-Source Breakdown Voltage	$V_{GS}=0V, I_D=250\mu A$	200	---	---	V
$I_{DSS}$	Zero Gate Voltage Drain Current	$V_{DS}=200V, V_{GS}=0V$	---	---	1	$\mu A$
$V_{GS(th)}$	Gate Threshold Voltage	$V_{DS}=V_{GS}, I_D=250\mu A$	2.5	3.5	4.5	V
$I_{GSS}$	Gate Leakage Current	$V_{GS}=\pm 20V, V_{DS}=0V$	---	---	$\pm 100$	nA
$R_{DS(ON)}$	Drain-Source On-state Resistance	$V_{GS}=10V, I_D=18A$	---	70	80	m $\Omega$
<b>Dynamic Characteristics</b> <sup>⑤</sup>						
$g_{FS}$	Gate Resistance	$V_{DS}=5V, I_D=18A$	---	38	---	S
$C_{iss}$	Input Capacitance	$V_{GS}=0V,$ $V_{DS}=100V,$ Freq.=1MHz	---	950	---	pF
$C_{oss}$	Output Capacitance		---	82	---	
$C_{rSS}$	Reverse Transfer Capacitance		---	3	---	
$T_{d(on)}$	Turn-on Delay Time	$V_{DS}=100V, V_{GS}=10V,$ $R_G=3\Omega, R_L=5.5\Omega$	---	6	---	nS
$T_r$	Turn-on Rise Time		---	7	---	
$T_{d(off)}$	Turn-off Delay Time		---	15	---	
$T_f$	Turn-off Fall Time		---	5	---	
$Q_g$	Total Gate Charge	$V_{DS}=100V, V_{GS}=10V,$ $I_D=18A$	---	18	---	nC
$Q_{gs}$	Gate-Source Charge		---	7.5	---	
$Q_{gd}$	Gate-Drain Charge		---	4.5	---	
<b>Source-Drain Characteristics</b>						
$V_{SD}$	Diode Forward Voltage	$I_S=18A, V_{GS}=0V$	---	---	1.3	V
$t_{rr}$	Reverse Recovery Time	$I_F=18A, V_{GS}=0V,$ $di_F/dt=100A/\mu s$	---	30	---	nS
$Q_{rr}$	Reverse Recovery Charge		---	125	---	nC

Note ④: Pulse test (pulse width $\leq 300\mu s$ , duty cycle $\leq 2\%$ ).

Note ⑤: Guaranteed by design, not subject to production testing.

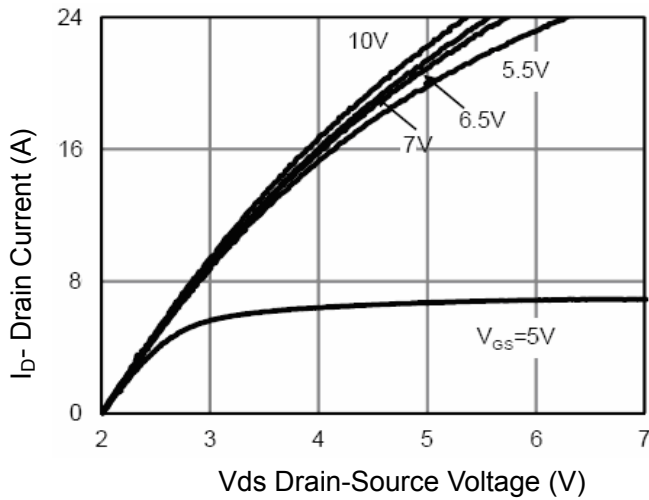
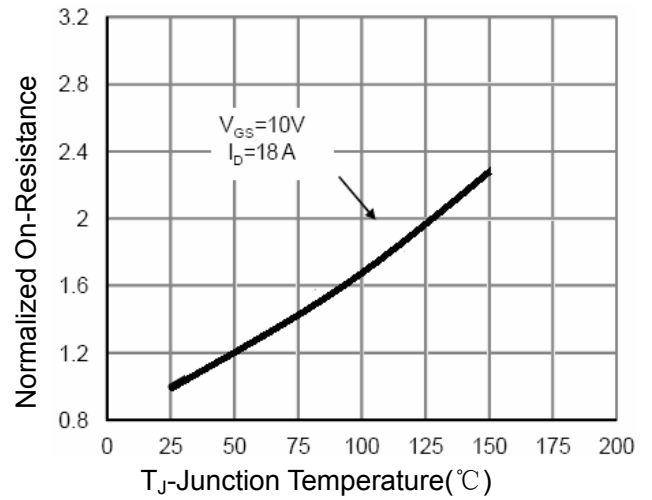
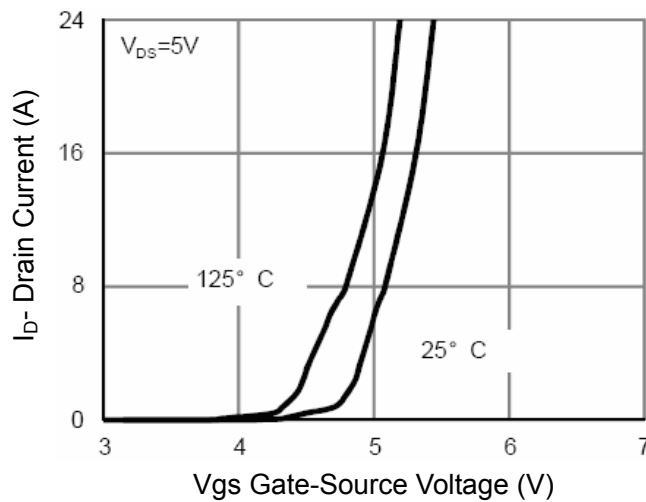
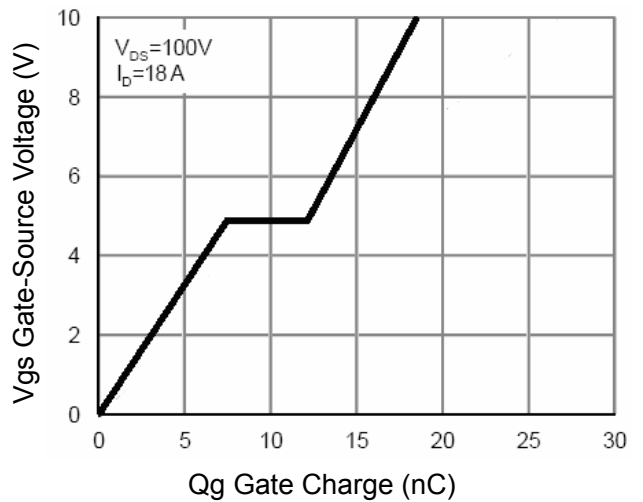
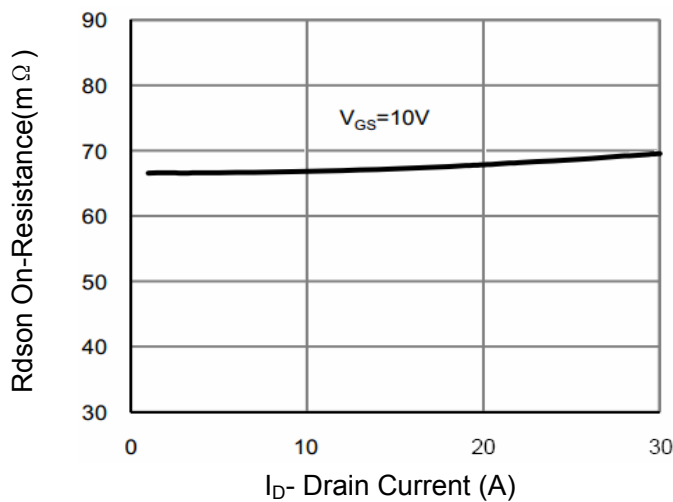
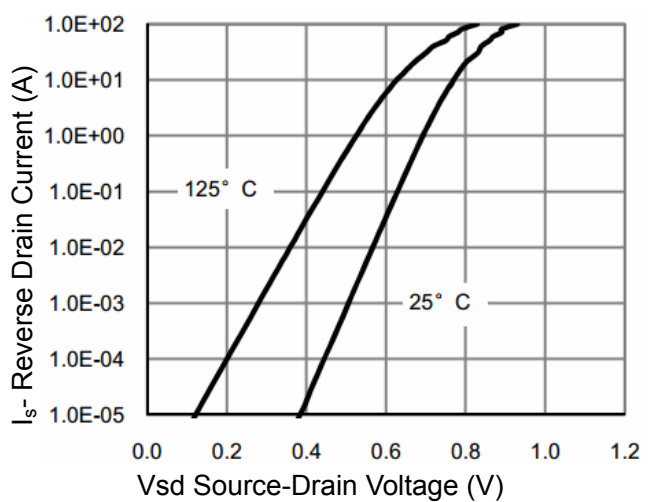
**N-Channel Enhancement Mode MOSFET**
**Typical Characteristics**

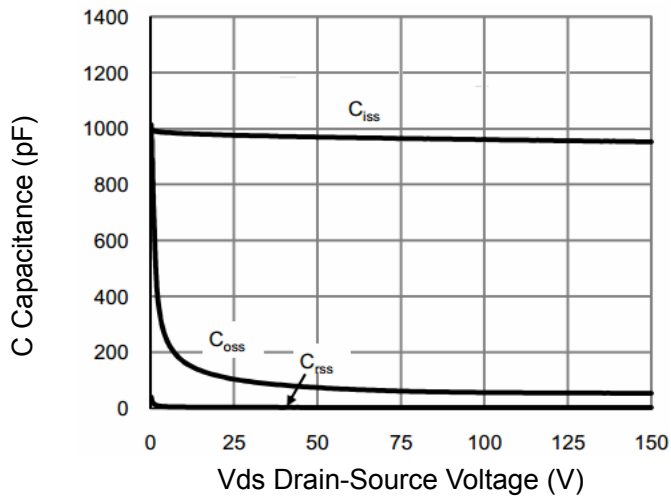
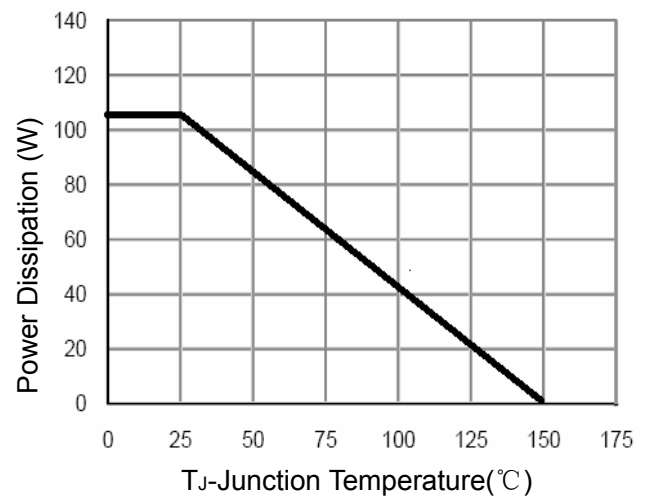
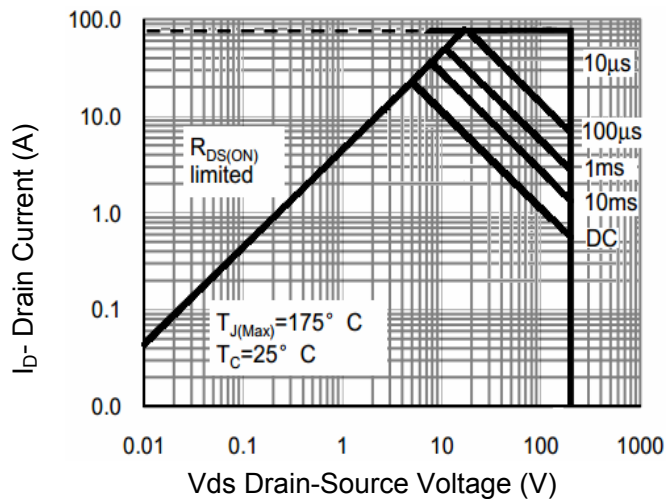
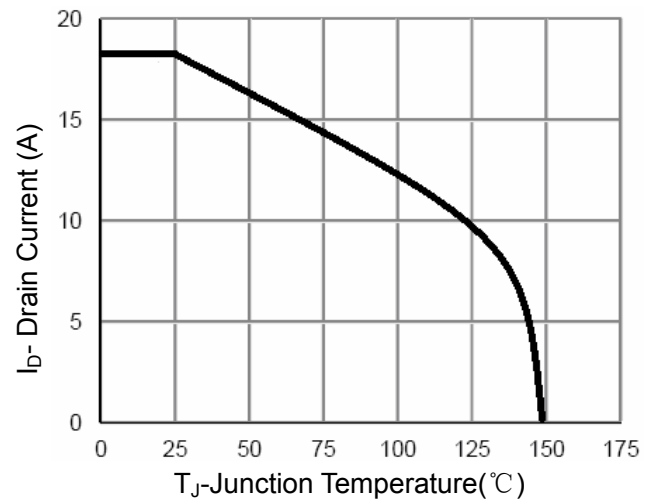
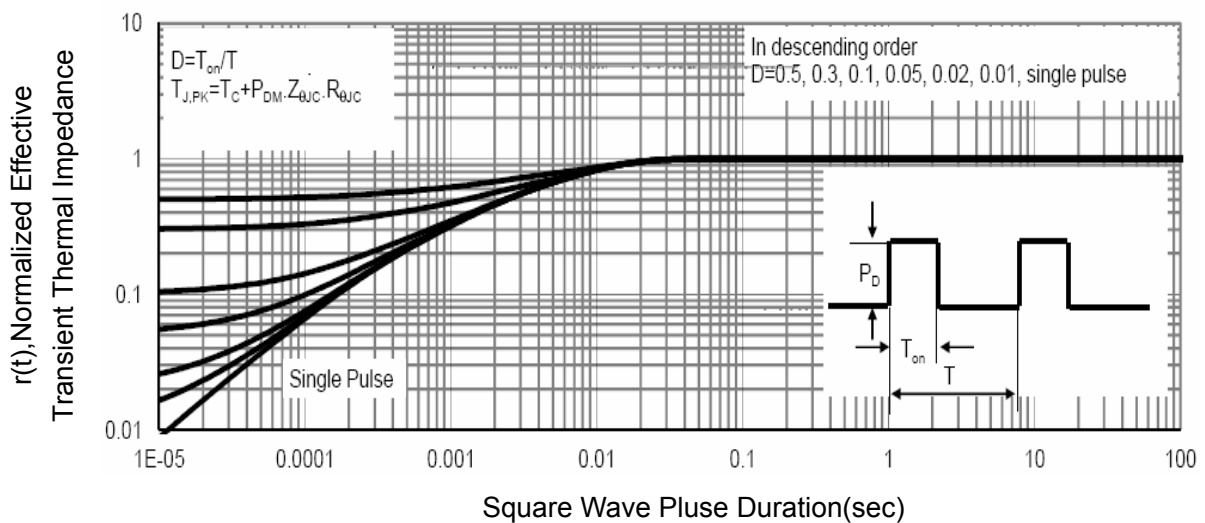
**Figure 1 Output Characteristics**

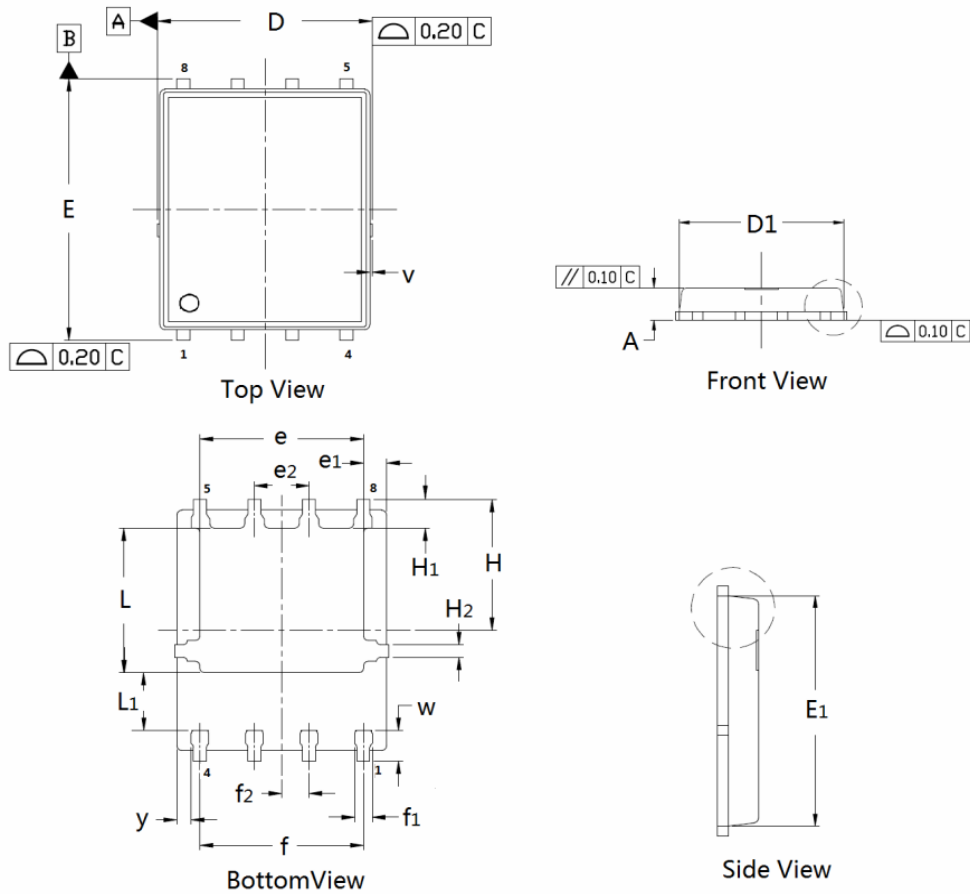
**Figure 2 Rdson-Junction Temperature**

**Figure 3 Transfer Characteristics**

**Figure 4 Gate Charge**

**Figure 5 Rdson- Drain Current**

**Figure 6 Source- Drain Diode Forward**

**N-Channel Enhancement Mode MOSFET**

**Figure 7 Capacitance vs Vds**

**Figure 8 Power De-rating**

**Figure 9 Safe Operation Area**

**Figure 10 Current De-rating**

**Figure 11 Normalized Maximum Transient Thermal Impedance**

**N-Channel Enhancement Mode MOSFET**
**DFN5×6 Package Outline Data**

**DIMENSIONS ( unit : mm )**

Symbol		Typ	Max	Symbol	Min	Typ	Max
A	0.90	1.02	1.10	D	4.90	4.98	5.10
D <sub>1</sub>	4.80	4.89	5.10	E	5.90	6.11	6.25
E <sub>1</sub>	5.65	5.74	5.95	e	3.72	3.80	3.92
e <sub>1</sub>	--	0.5	--	e <sub>2</sub>	--	1.	--
f	--	3.8	--	f <sub>1</sub>	0.31	0.37	0.51
f <sub>2</sub>	--	0.6	--	H	--	3.	--
H <sub>1</sub>	0.59	0.63	0.79	H <sub>2</sub>	0.26	0.28	0.32
L	3.35	3.45	3.65	L <sub>1</sub>	--	1.	--
v	--	0.1	--	w	0.64	0.68	0.84
y	--	0.3	--		--		--