

N-Channel Enhancement Mode MOSFET

Features

- Fast switching speed
- Reliable and Rugged
- ROHS Compliant
- 100% UIS and Rg Tested

Applications

- Power Management in Desktop Computer
- DC/DC Converters

Pin Description

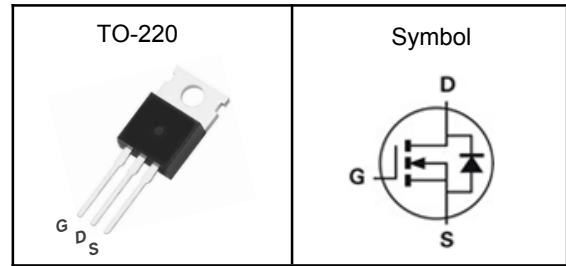

| | | |
|------------------|-----|-----------|
| V_{DSS} | 200 | V |
| $R_{DS(ON)-Typ}$ | 22 | $m\Omega$ |
| I_D | 80 | A |

Absolute Maximum Ratings ($T_J=25^\circ C$, Unless Otherwise Noted)

| Symbol | Parameter | N-Channel | Unit |
|--------------|--|------------------|------------|
| V_{DSS} | Drain-Source Voltage | 200 | V |
| V_{GSS} | Gate-Source Voltage | ± 20 | V |
| T_J | Maximum Junction Temperature | -55 to 150 | $^\circ C$ |
| T_{STG} | Storage Temperature Range | -55 to 150 | $^\circ C$ |
| E_{AS} | Single Pulse Avalanche Energy ^③ | 625 | mJ |
| $I_{DM}^{①}$ | Pulse Drain Current Tested | 320 | A |
| I_D | Continuous Drain Current | $T_C=25^\circ C$ | A |
| P_D | Maximum Power Dissipation | $T_C=25^\circ C$ | W |

Thermal Characteristics

| Symbol | Parameter | Rating | Unit |
|-----------------|---|--------|--------------|
| $R_{\theta JA}$ | Thermal Resistance-Junction to Ambient | 62.5 | $^\circ C/W$ |
| $R_{\theta JC}$ | Thermal Resistance Junction-Case ^① | 0.4 | $^\circ C/W$ |

Note ① : Max. current is limited by bonding wire.

Note ② : UIS tested and pulse width are limited by maximum junction temperature 150 $^\circ C$.

Note ③ : Surface Mounted on 1in² FR-4 board with 1oz.

**N-Channel Enhancement Mode MOSFET****Electrical Characteristics** ($T_J=25^\circ\text{C}$, Unless Otherwise Noted)

| Symbol | Parameter | Test Conditions | Min | Typ | Max | Unit |
|--|------------------------------------|--|-----|------|-----------|-----------|
| Static Electrical Characteristics | | | | | | |
| BV_{DSS} | Drain-Source Breakdown Voltage | $V_{GS}=0V, I_D=250\mu A$ | 200 | --- | --- | V |
| I_{DSS} | Zero Gate Voltage Drain Current | $V_{DS}=200V, V_{GS}=0V$ | --- | --- | 1 | μA |
| $V_{GS(th)}$ | Gate Threshold Voltage | $V_{DS}=V_{GS}, I_D=250\mu A$ | 2 | 3 | 4 | V |
| I_{GSS} | Gate Leakage Current | $V_{GS}=\pm 20V, V_{DS}=0V$ | --- | --- | ± 100 | nA |
| $R_{DS(ON)}$ | Drain-Source On-state Resistance | $V_{GS}=10V, I_D=40A$ | --- | 22 | 28 | $m\Omega$ |
| Dynamic Characteristics ^⑤ | | | | | | |
| C_{iss} | Input Capacitance | $V_{GS}=0V,$ $V_{DS}=100V,$ Freq.=1MHz | --- | 6255 | --- | pF |
| C_{oss} | Output Capacitance | | --- | 450 | --- | |
| C_{rss} | Reverse Transfer Capacitance | | --- | 110 | --- | |
| $T_{d(on)}$ | Turn-on Delay Time | $V_{DD}=100V, I_D=40A,$ $V_{GS}=10V, R_G=6\Omega$ | --- | 26 | --- | nS |
| T_r | Turn-on Rise Time | | --- | 33 | --- | |
| $T_{d(off)}$ | Turn-off Delay Time | | --- | 75 | --- | |
| T_f | Turn-off Fall Time | | --- | 21 | --- | |
| Q_g | Total Gate Charge | $V_{DS}=100V, V_{GS}=10V,$ $I_D=40A$ | --- | 140 | --- | nC |
| Q_{gs} | Gate-Source Charge | | --- | 29 | --- | |
| Q_{gd} | Gate-Drain Charge | | --- | 56 | --- | |
| Source-Drain Characteristics ($T_J=25^\circ\text{C}$) | | | | | | |
| V_{SD} | Diode Forward Voltage ^z | $V_{GS}=0V, I_S=40A, T_J=25^\circ\text{C}$ | --- | --- | 1.2 | V |
| t_{rr} | Reverse Recovery Time | $I_F=40A, V_{GS}=0V$ $di/dt=100A/\mu s, T_J=25^\circ\text{C}$ | --- | 49 | --- | nS |
| Q_{rr} | Reverse Recovery Charge | | --- | 80 | --- | nC |

Note ④ : Pulse test (pulse width $\leq 300\mu s$, duty cycle $\leq 2\%$).

Note ⑤ : Guaranteed by design, not subject to production testing.

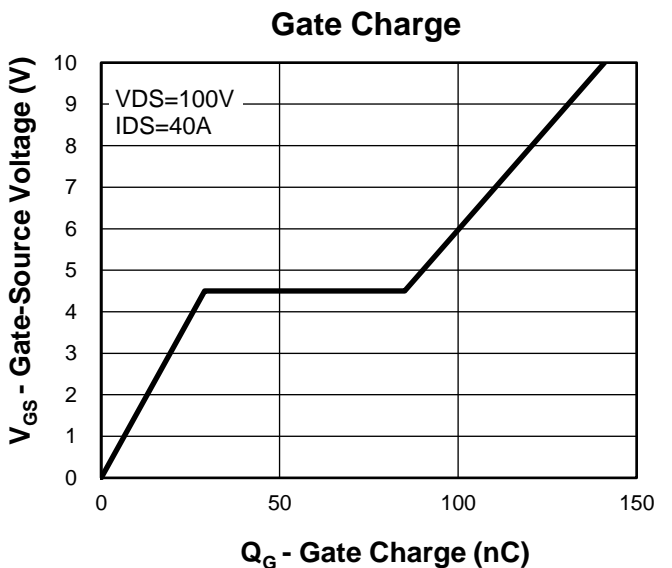
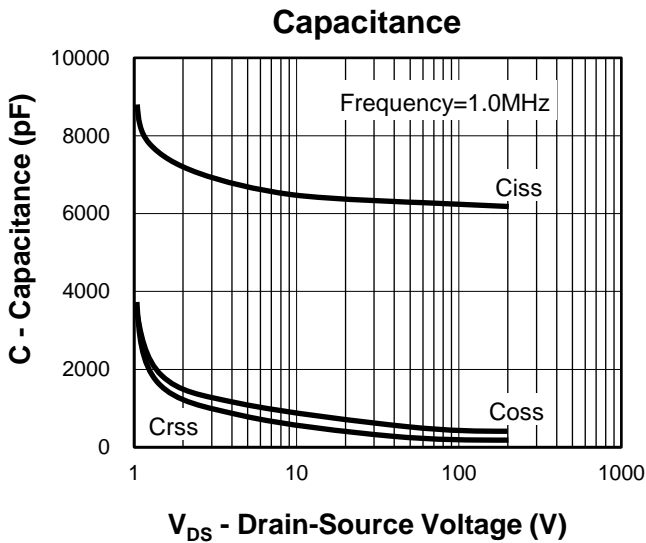
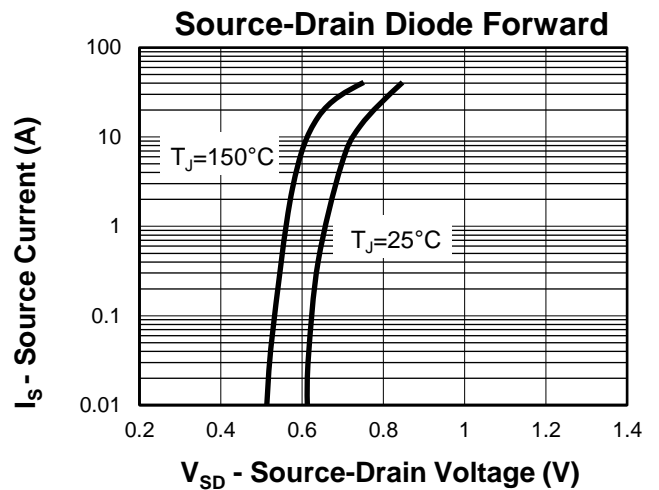
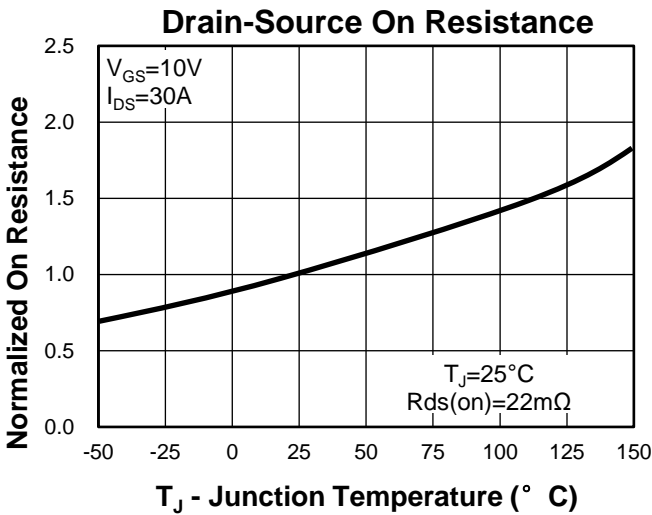
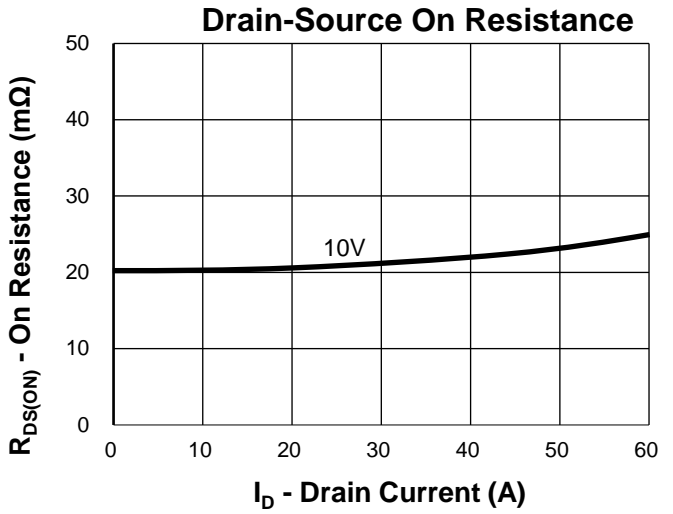
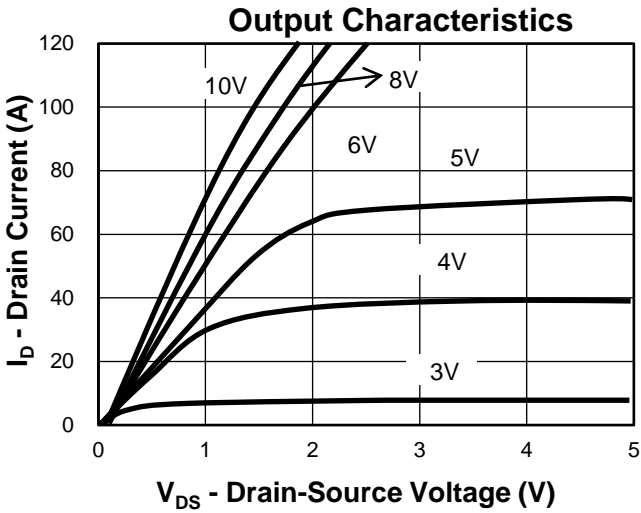
N-Channel Enhancement Mode MOSFET
Typical Characteristics

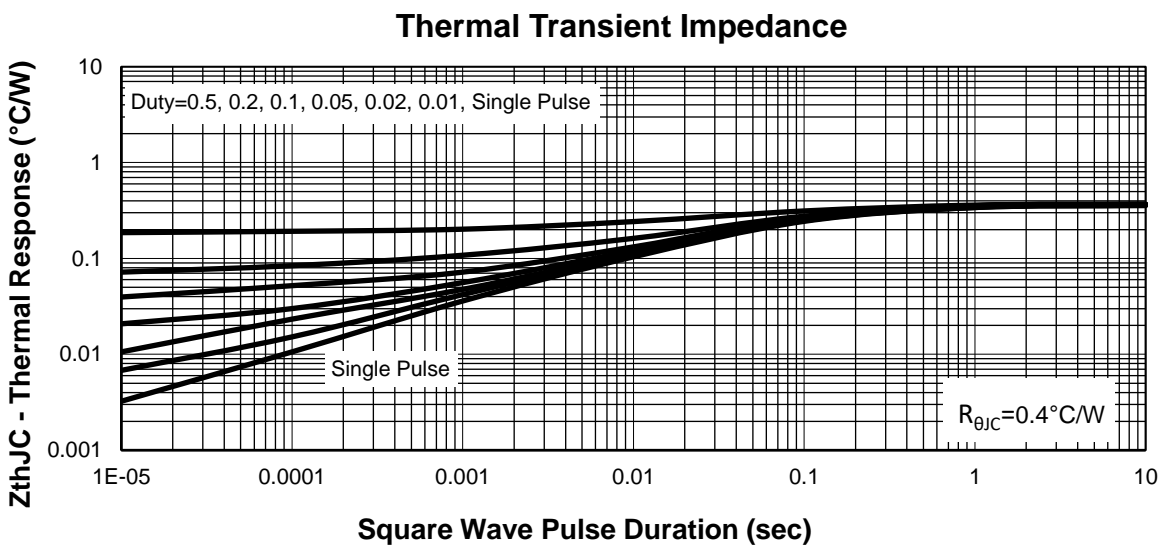
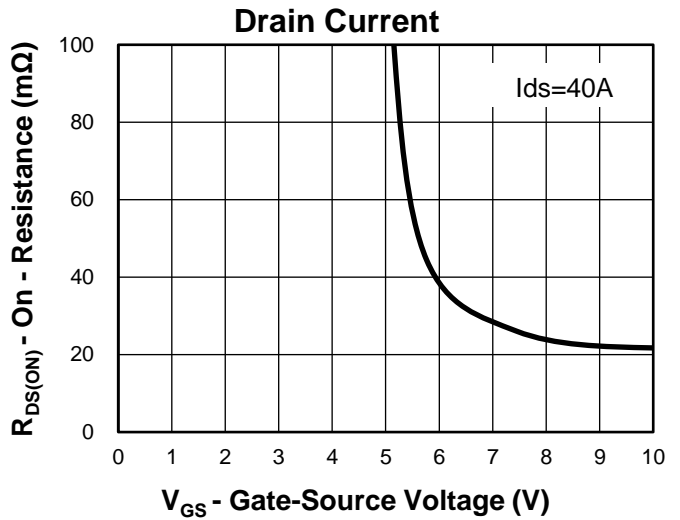
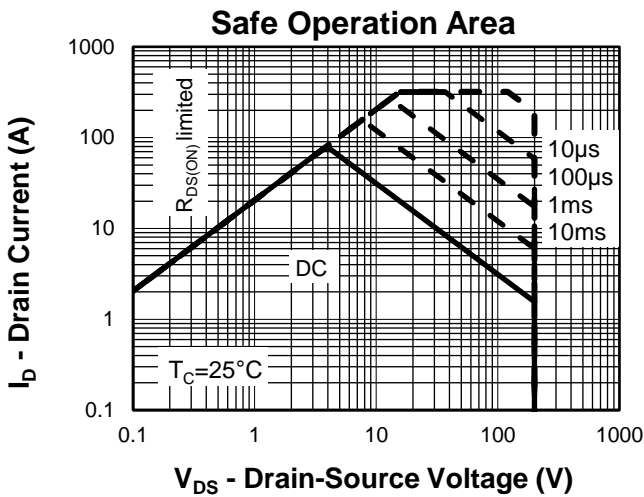
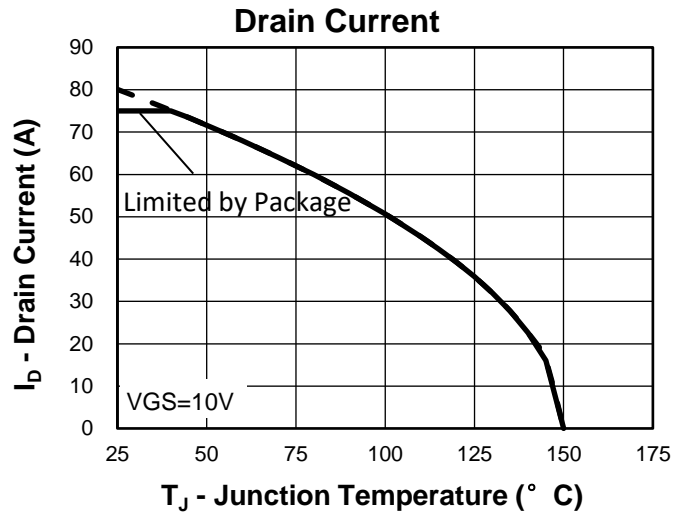
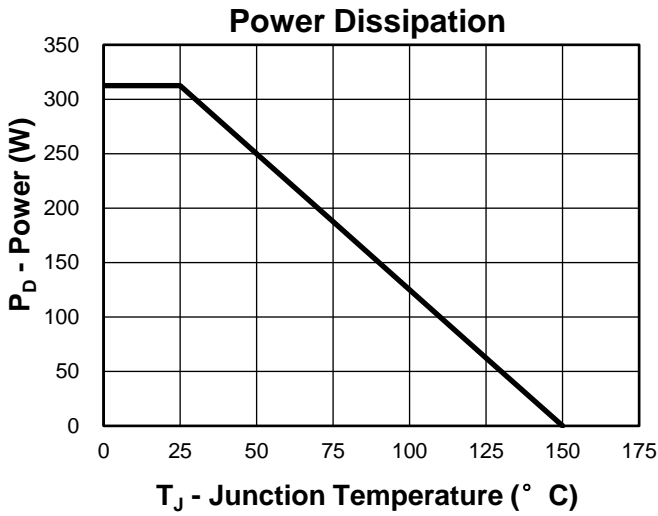
N-Channel Enhancement Mode MOSFET

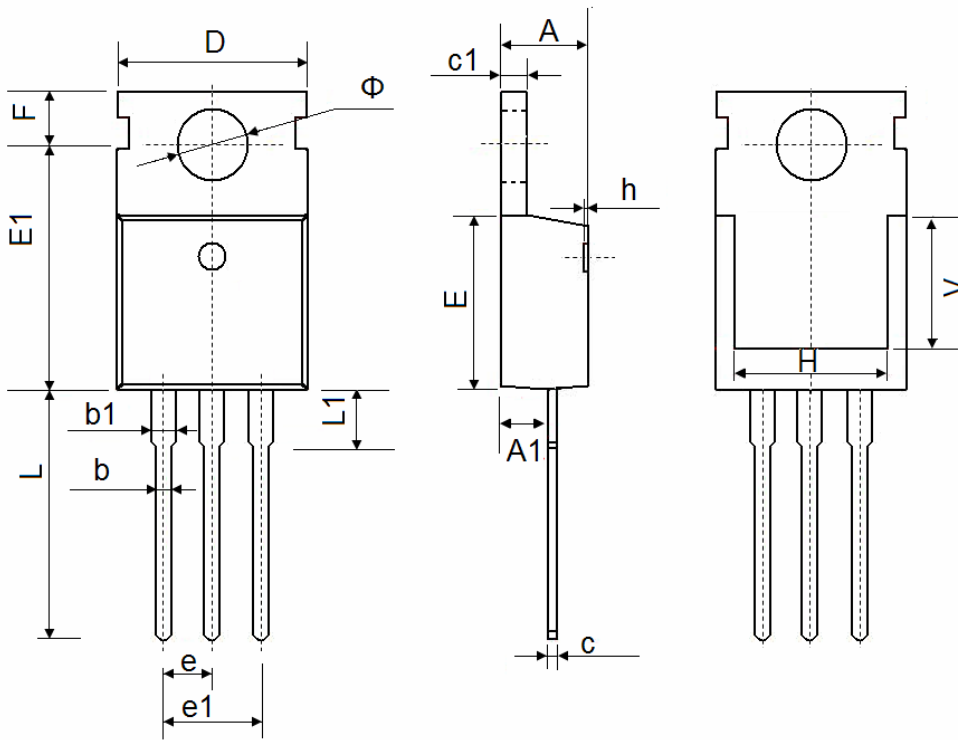
N-Channel Enhancement Mode MOSFET
TO-220 Package Outline Data

| Symbol | Dimensions In Millimeters | |
|--------|---------------------------|--------|
| | Min. | Max. |
| A | 4.350 | 4.650 |
| A1 | 2.250 | 2.550 |
| b | 0.710 | 0.910 |
| b1 | 1.170 | 1.400 |
| c | 0.330 | 0.650 |
| c1 | 1.200 | 1.400 |
| D | 9.910 | 10.250 |
| E | 8.9500 | 9.750 |
| E1 | 12.650 | 12.950 |
| e | 2.540 TYP. | |
| e1 | 4.980 | 5.180 |
| F | 2.650 | 2.950 |
| H | 7.900 | 8.100 |
| h | 0.000 | 0.300 |
| L | 12.700 | 13.500 |
| L1 | 2.850 | 3.250 |
| V | 7.500 REF. | |
| Φ | 3.400 | 3.800 |