

# N-Channel Enhancement Mode MOSFET

## Features

- Fast switching speed
- Reliable and Rugged
- ROHS Compliant
- 100% UIS and Rg Tested

## Applications

- High Frequency Point-of-Load Synchronous Buck Converter
- Networking DC-DC Power System
- Load Switch

## Pin Description

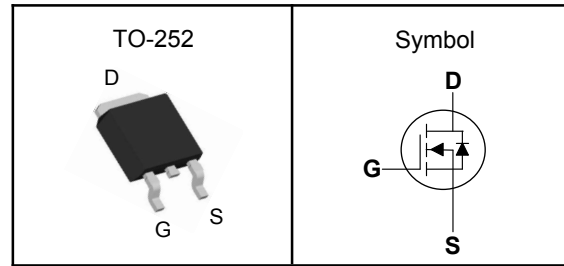

$V_{DSS}$	150	V
$R_{DS(ON)-Typ}$	70	m $\Omega$
$I_D$	20	A

## Absolute Maximum Ratings ( $T_J=25^\circ\text{C}$ , Unless Otherwise Noted)

Symbol	Parameter	N-Channel	Unit
$V_{DSS}$	Drain-Source Voltage	150	V
$V_{GSS}$	Gate-Source Voltage	$\pm 20$	V
$T_J$	Maximum Junction Temperature	-55 to 150	$^\circ\text{C}$
$T_{STG}$	Storage Temperature Range	-55 to 150	$^\circ\text{C}$
$E_{AS}$	Single Pulse Avalanche Energy <sup>③</sup>	53	mJ
$I_{DM}^{①}$	Pulse Drain Current Tested	40	A
$I_D$	Continuous Drain Current	$T_c=25^\circ\text{C}$	A
$P_D$	Maximum Power Dissipation	$T_c=25^\circ\text{C}$	W

## Thermal Characteristics

Symbol	Parameter	Rating	Unit
$R_{\theta JA}$	Thermal Resistance Junction-Ambient <sup>①</sup> (Max)	62	$^\circ\text{C}/\text{W}$
$R_{\theta JC}$	Thermal Resistance Junction-Case <sup>①</sup>	1.72	$^\circ\text{C}/\text{W}$

Note ① : Max. current is limited by bonding wire.

Note ② : UIS tested and pulse width are limited by maximum junction temperature  $150^\circ\text{C}$ .

Note ③ : Surface Mounted on  $1\text{in}^2$  FR-4 board with 1oz.



**N-Channel Enhancement Mode MOSFET**

**Electrical Characteristics** ( $T_J=25^{\circ}\text{C}$ , Unless Otherwise Noted)

Symbol	Parameter	Test Conditions	Min	Typ	Max	Unit
<b>Static Electrical Characteristics</b>						
$BV_{DSS}$	Drain-Source Breakdown Voltage	$V_{GS}=0V, I_D=250mA$	150	---	---	V
$I_{DSS}$	Zero Gate Voltage Drain Current	$V_{DS}=120V, V_{GS}=0V$	---	---	1	$\mu A$
$V_{GS(th)}$	Gate Threshold Voltage	$V_{DS}=V_{GS}, I_D=250\mu A$	2.0	---	4.0	V
$I_{GSS}$	Gate Leakage Current	$V_{GS}=\pm 20V, V_{DS}=0V$	---	---	$\pm 100$	nA
$R_{DS(on)}$	Drain-Source On-state Resistance	$V_{GS}=10V, I_D=10A$	---	70	88	$m\Omega$
		$V_{GS}=4.5V, I_D=10A$	---	80	100	$m\Omega$
<b>Dynamic Characteristics</b> <sup>⑤</sup>						
$C_{iss}$	Input Capacitance	$V_{GS}=0V, V_{DS}=25V, \text{Freq.}=1MHz$	---	2285	---	pF
$C_{oss}$	Output Capacitance		---	110	---	
$C_{rss}$	Reverse Transfer Capacitance		---	83	---	
$T_{d(on)}$	Turn-on Delay Time	$V_{DD}=75V, V_{GS}=10V, R_G=3.3\Omega, I_D=10A$	---	13	---	nS
$T_r$	Turn-on Rise Time		---	8.2	---	
$T_{d(off)}$	Turn-off Delay Time		---	25	---	
$T_f$	Turn-off Fall Time		---	11	---	
$Q_g$	Total Gate Charge	$V_{DS}=75V, V_{GS}=4.5V, I_D=10A$	---	25.1	---	nC
$Q_{gs}$	Gate-Source Charge		---	6.8	---	
$Q_{gd}$	Gate-Drain Charge		---	12.6	---	
<b>Source-Drain Characteristics</b> ( $T_J=25^{\circ}\text{C}$ )						
$V_{SD}$	Diode Forward Voltage <sup>②</sup>	$V_{GS}=0V, I_S=1A, T_J=25^{\circ}\text{C}$	---	---	1.2	V
$t_{rr}$	Reverse Recovery Time	$I_F=10A, di/dt=100A/\mu s, T_J=25^{\circ}\text{C}$	---	37	---	nS
$Q_{rr}$	Reverse Recovery Charge		---	263	---	nC

Note ④ : Pulse test (pulse width $\leq 300\mu s$ , duty cycle $\leq 2\%$ ).

Note ⑤ : Guaranteed by design, not subject to production testing.

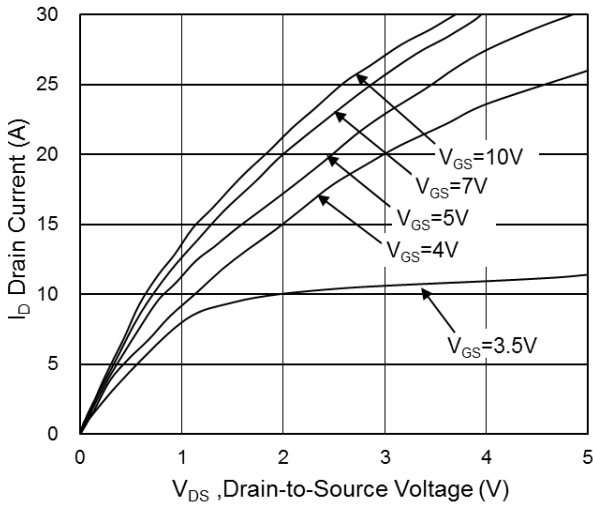
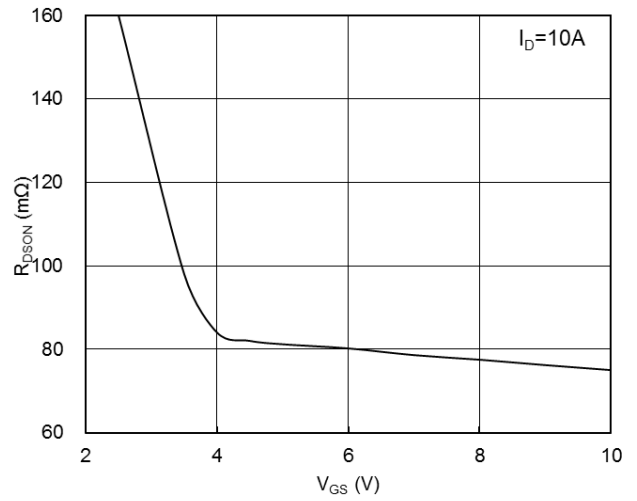
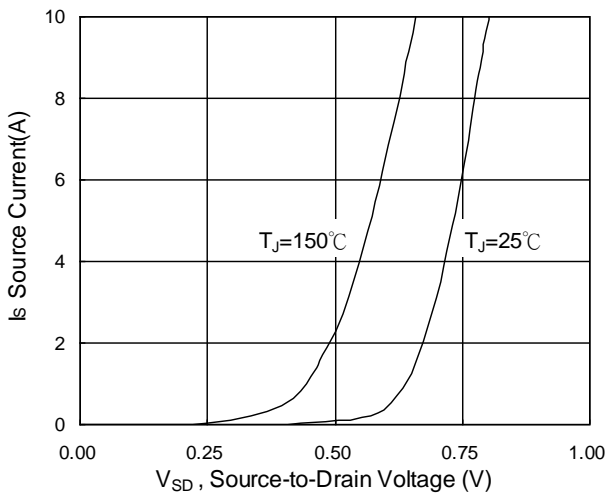
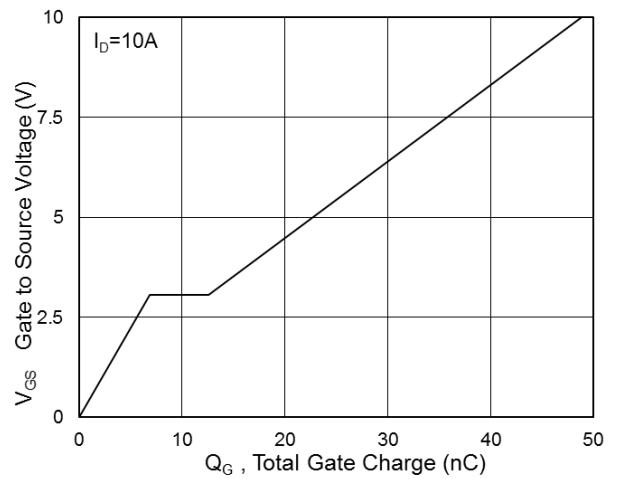
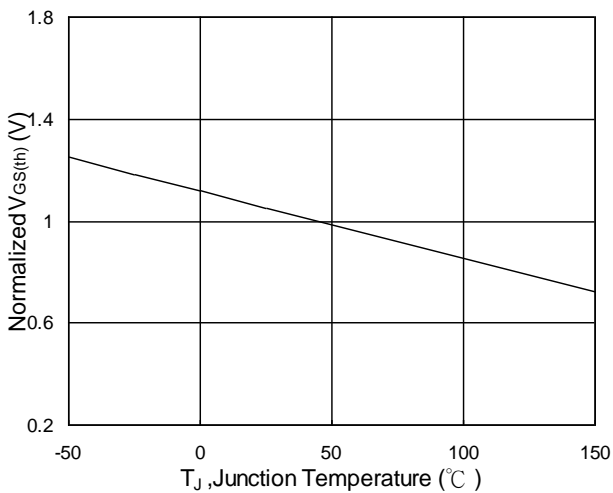
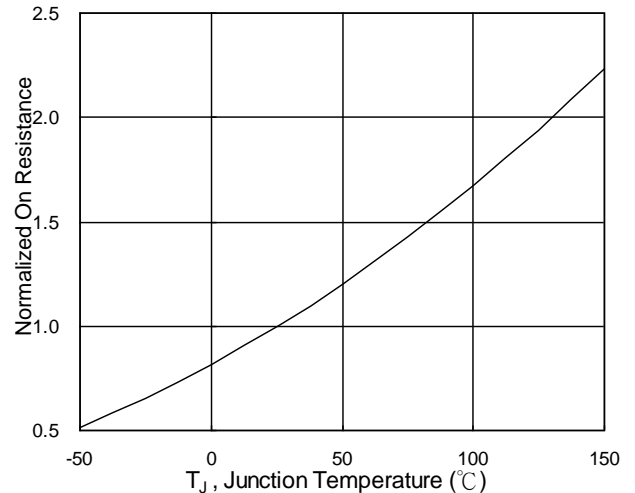
**N-Channel Enhancement Mode MOSFET**
**Typical Characteristics**

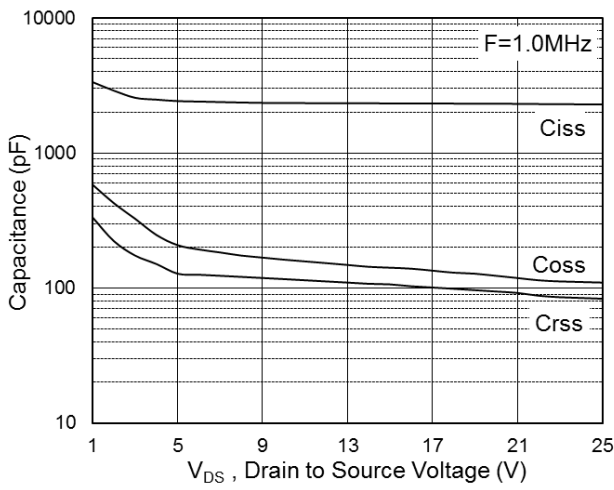
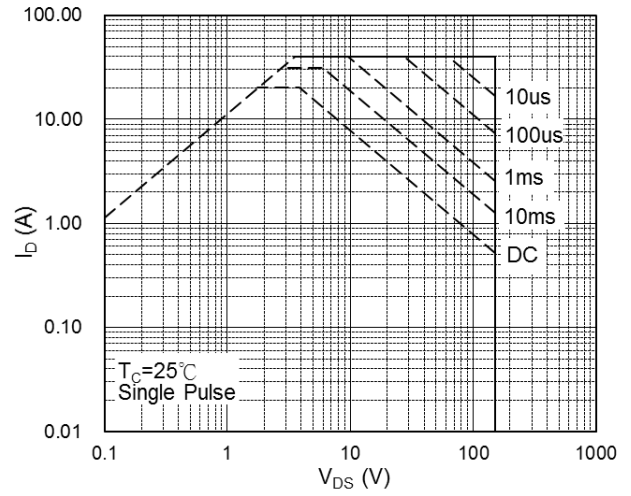
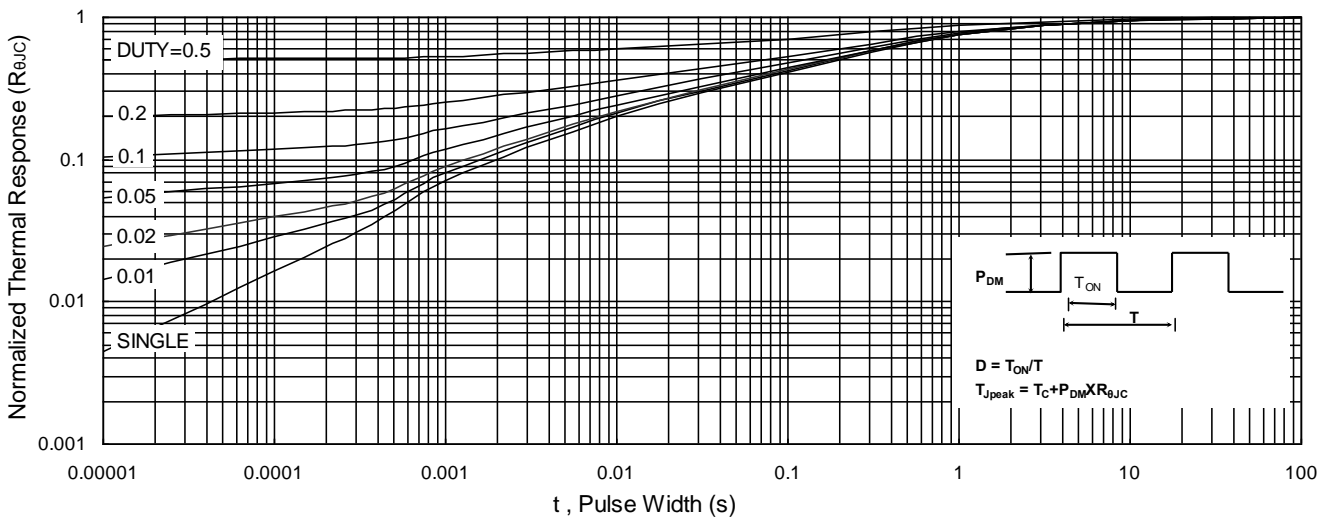
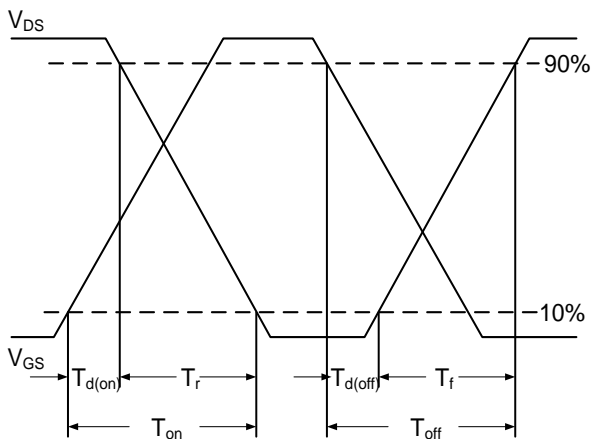
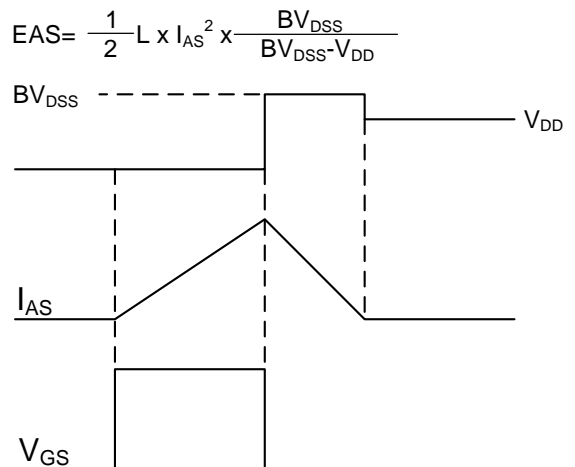
**Fig.1 Typical Output Characteristics**

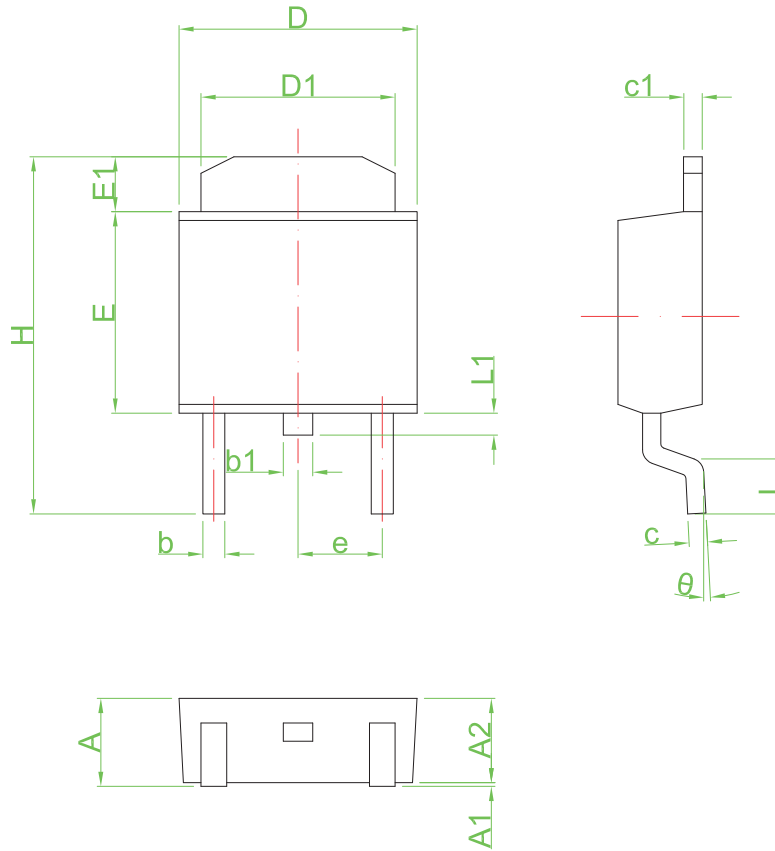
**Fig.2 On-Resistance vs. Gate-Source Voltage**

**Fig.3 Forward Characteristics of Reverse**

**Fig.4 Gate-Charge Characteristics**

**Fig.5 Normalized  $V_{GS(th)}$  vs.  $T_J$** 

**Fig.6 Normalized  $R_{DSON}$  vs.  $T_J$**

**N-Channel Enhancement Mode MOSFET**

**Fig.7 Capacitance**

**Fig.8 Safe Operating Area**

**Fig.9 Normalized Maximum Transient Thermal Impedance**

**Fig.10 Switching Time Waveform**

**Fig.11 Unclamped Inductive Switching Waveform**

**N-Channel Enhancement Mode MOSFET**
**TO-252 Package Outline Dimensions**

Symbol	Dimensions in Millimeters		Dimensions in Inches	
	Min	Max	Min	Max
A	2.25	2.65	0.089	0.104
A1	0.00	0.15	0.000	0.006
A2	2.20	2.40	0.087	0.094
b	0.50	0.70	0.020	0.028
b1	0.70	0.90	0.028	0.035
c	0.46	0.66	0.018	0.026
c1	0.46	0.66	0.018	0.026
D	6.30	6.70	0.248	0.264
D1	5.20	5.40	0.205	0.213
E	5.30	5.70	0.209	0.224
E1	1.40	1.60	0.055	0.063
H	9.40	9.90	0.370	0.390
e	2.30 TYP		0.09 TYP	
L	1.40	1.77	0.055	0.070
L1	0.50	0.70	0.020	0.028
θ	0°	8°	0°	8°