

N-Channel Enhancement Mode MOSFET

Features

- High Speed Power Switching
- Reliable and Rugged
- ROHS Compliant
- 100% Avalanche Tested

Applications

- Power Management in Desktop Computer
- DC/DC Converters

Pin Description

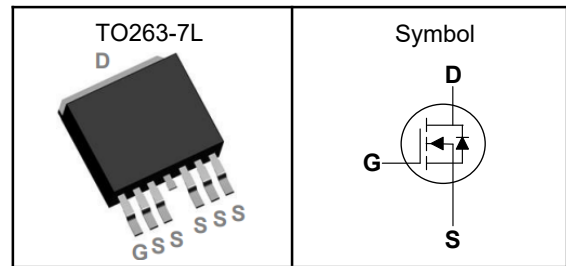

V_{DSS}	150	V
$R_{DS(ON)-Typ}$	4.5	m Ω
I_D	220	A

Absolute Maximum Ratings ($T_C=25^{\circ}C$, Unless Otherwise Noted)

Symbol	Parameter	Rating	Unit
V_{DSS}	Drain-Source Voltage	150	V
V_{GSS}	Gate-Source Voltage	± 25	V
T_J	Maximum Junction Temperature	-55 to 175	$^{\circ}C$
T_{STG}	Storage Temperature Range	-55 to 175	$^{\circ}C$
$I_{DM}^{①}$	Pulse Drain Current Tested	680	A
I_D	Continuous Drain Current	220	A
P_D	Maximum Power Dissipation	250	W
E_{AS}	Avalanche Energy, Single pulse	1250	mJ

Thermal Characteristics

Symbol	Parameter	Rating	Unit
$R_{\theta JA}$	Thermal Resistance-Junction to Ambient	40	$^{\circ}C/W$
$R_{\theta JC}$	Thermal Resistance-Junction to Case	0.6	$^{\circ}C/W$

Note ① : Max. current is limited by bonding wire.

Note ② : UIS tested and pulse width are limited by maximum junction temperature 150 $^{\circ}C$.

Note ③ : Surface Mounted on 1in² FR-4 board with 1oz.



N-Channel Enhancement Mode MOSFET

Electrical Characteristics ($T_J=25^{\circ}\text{C}$, Unless Otherwise Noted)

Symbol	Parameter	Test Conditions	Min	Typ	Max	Unit
Static Electrical Characteristics						
BV_{DSS}	Drain-Source Breakdown Voltage	$V_{GS}=0V, I_D=250\mu A$	150	---	---	V
I_{DSS}	Zero Gate Voltage Drain Current	$V_{DS}=120V, V_{GS}=0V$	---	---	1	μA
$V_{GS(th)}$	Gate Threshold Voltage	$V_{DS}=V_{GS}, I_D=250\mu A$	2	---	4	V
I_{GSS}	Gate Leakage Current	$V_{GS}=\pm 25V, V_{DS}=0V$	---	---	± 100	nA
$R_{DS(ON)}$	Drain-Source On-state Resistance	$V_{GS}=10V, I_D=50A$	---	4.5	5	$m\Omega$
		$V_{GS}=6V, I_D=25A$	---	5	6	$m\Omega$
Dynamic Characteristics ^⑤						
C_{iss}	Input Capacitance	$V_{DS}=75V, V_{GS}=0V, \text{Freq.}=1\text{MHz}$	---	9320	---	pF
C_{oss}	Output Capacitance		---	570	---	
C_{rSS}	Reverse Transfer Capacitance		---	60	---	
$T_{d(on)}$	Turn-on Delay Time	$V_{DS}=75V, V_{GS}=10V, I_D=50A, R_G=3.9\Omega$	---	24	---	nS
T_r	Turn-on Rise Time		---	70	---	
$T_{d(off)}$	Turn-off Delay Time		---	112	---	
T_f	Turn-off Fall Time		---	75	---	
Q_g	Total Gate Charge	$V_{DS}=75V, V_{GS}=10V, I_D=50A$	---	158	---	nC
Q_{gs}	Gate-Source Charge		---	48	---	
Q_{gd}	Gate-Drain Charge		---	39	---	
Source-Drain Characteristics						
V_{SD}	Diode Forward Voltage	$I_S=50A, V_{GS}=0V$	---	---	1.3	V
t_{rr}	Reverse Recovery Time	$I_F=50A, V_{GS}=0V, di_F/dt=100A/\mu s$	---	115	---	nS
Q_{rr}	Reverse Recovery Charge		---	480	---	nC

Note ④: Pulse test (pulse width $\leq 300\mu s$, duty cycle $\leq 2\%$).

Note ⑤: Guaranteed by design, not subject to production testing.

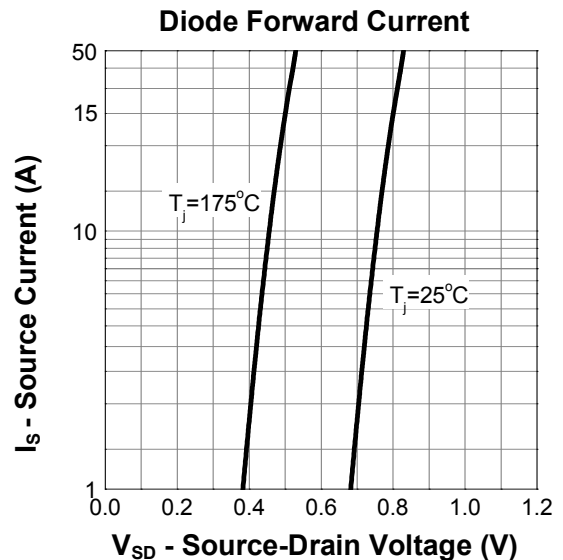
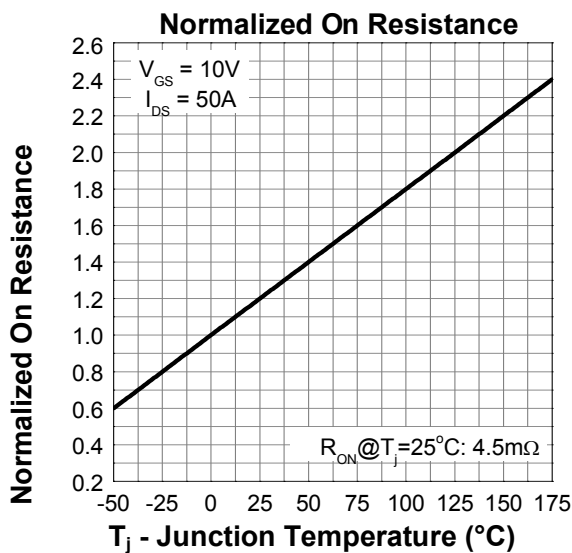
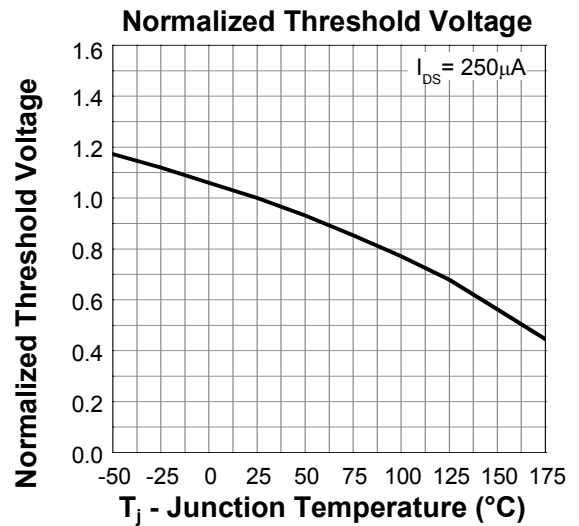
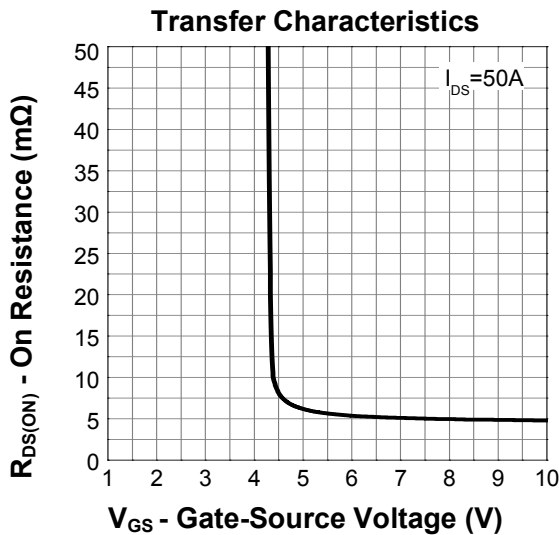
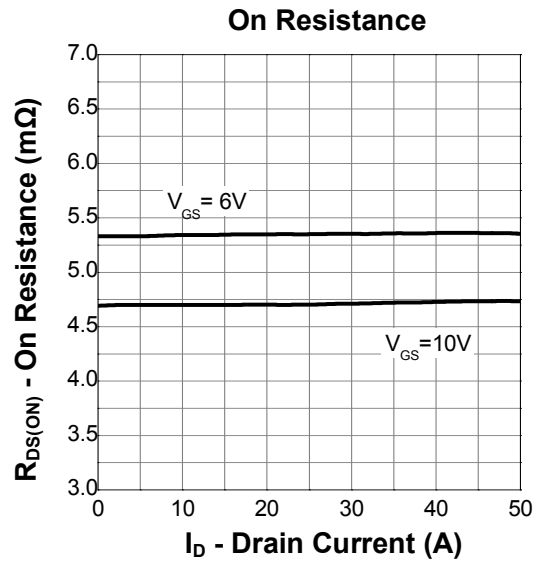
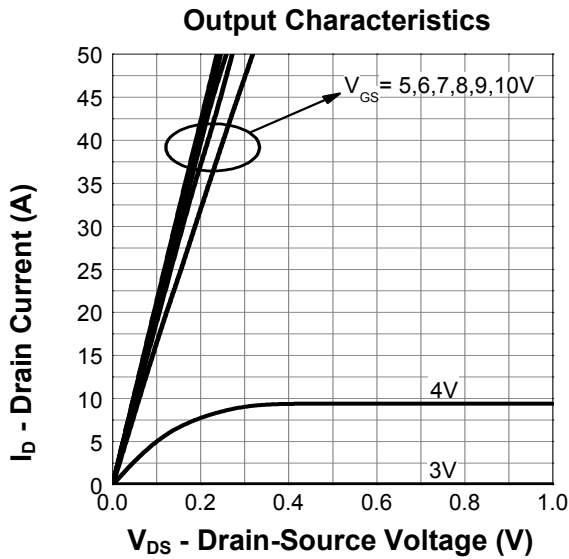
N-Channel Enhancement Mode MOSFET
Typical Characteristics



N-Channel Enhancement Mode MOSFET

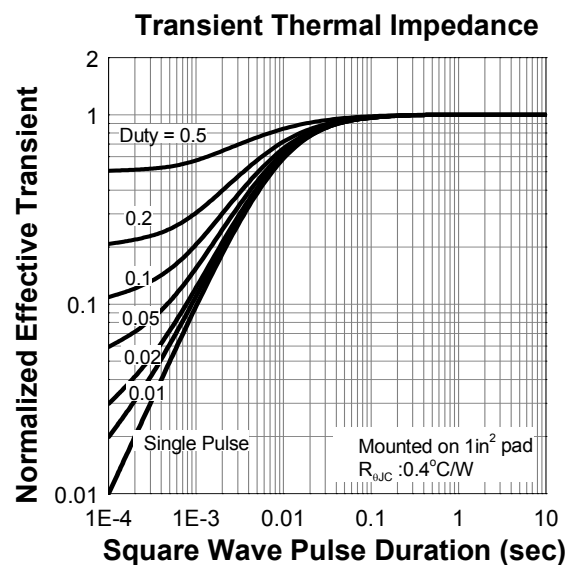
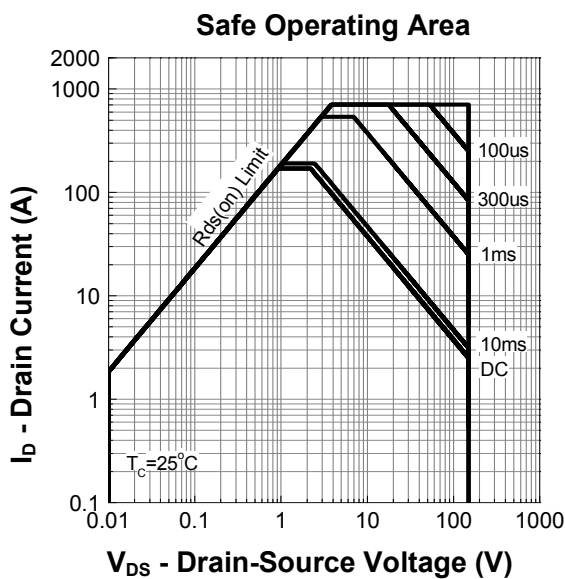
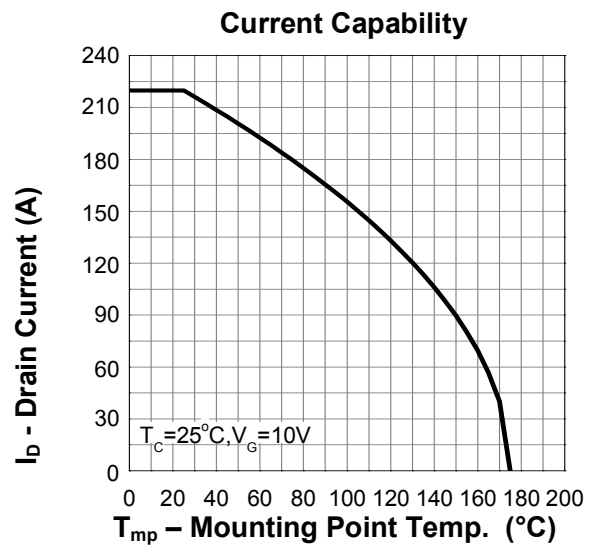
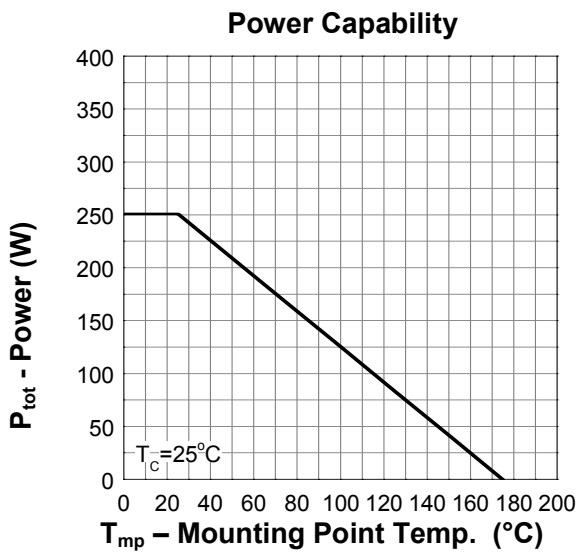
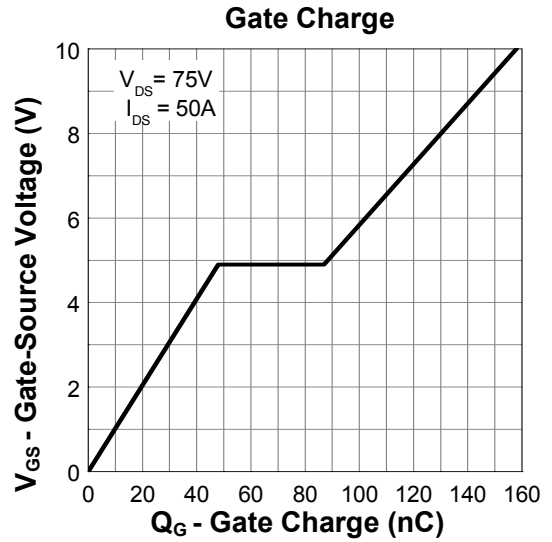
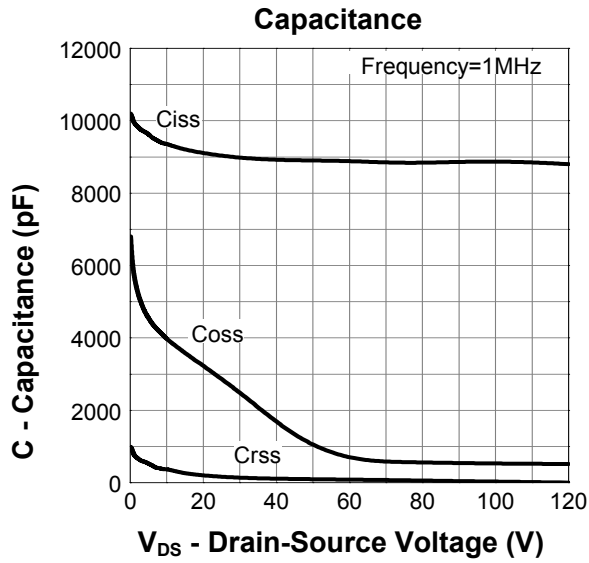

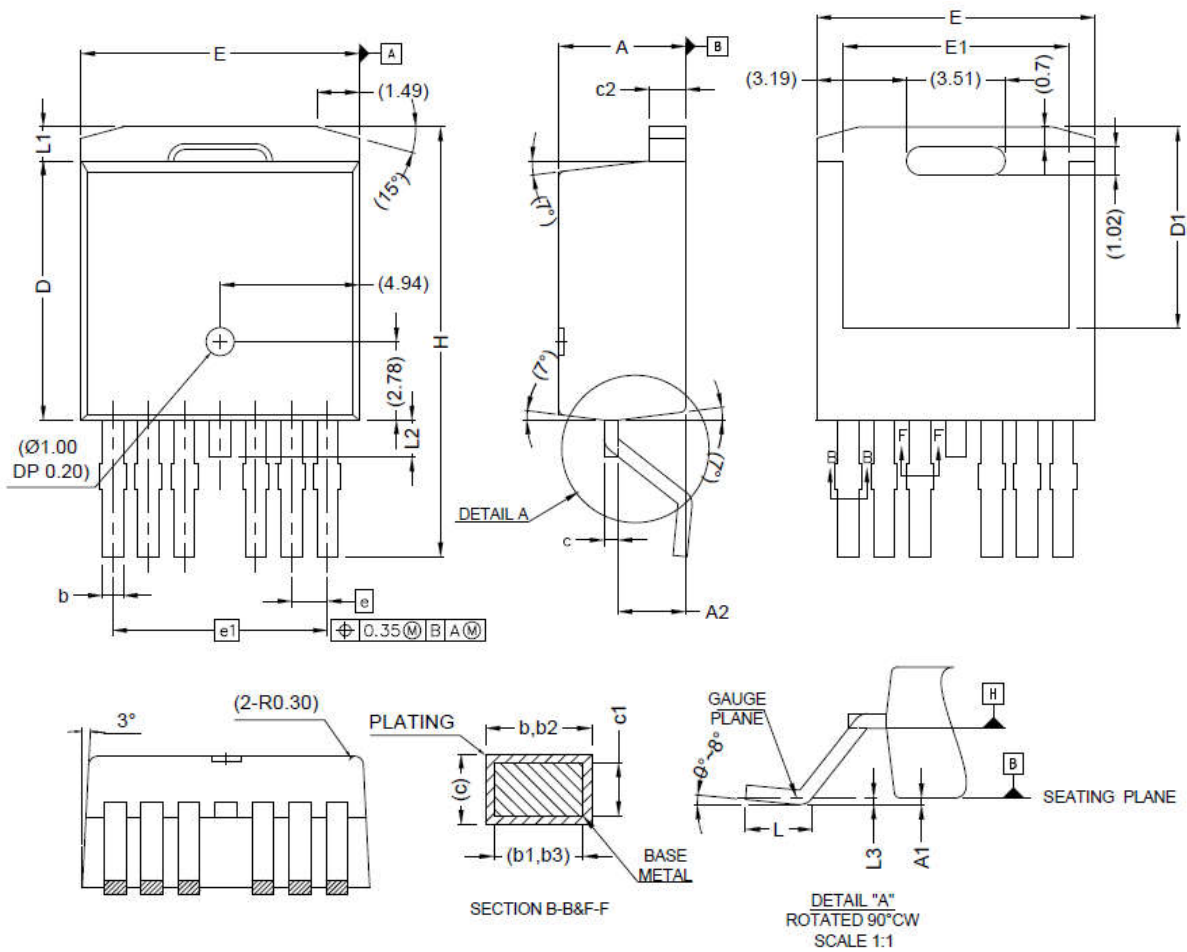
N-Channel Enhancement Mode MOSFET
TO263-7L Package Outline Data

SYMBOL	MIN	MAX
A	4.30	4.70
A1	-	0.25
A2	2.20	2.60
b	0.65	0.85
b1	0.65	0.80
b2	0.80	1.00
b3	0.80	0.95
c	0.45	0.60
c1	0.45	0.55
c2	1.25	1.40
D	9.00	9.40
D1	6.86	7.42
E	9.68	10.08
E1	7.70	8.30
e	1.27 BSC	
e1	7.62 BSC	
L	1.78	2.79
L1	-	1.60
L2	-	1.78
L3	0.25BSC	
H	14.61	15.88