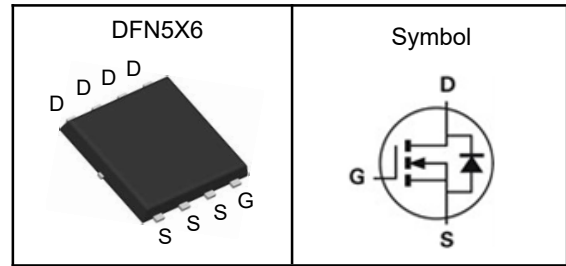


N-Channel Enhancement Mode MOSFET

Features

- Fast switching speed
- Reliable and Rugged
- ROHS Compliant
- 100% UIS and Rg Tested

Pin Description



Applications

- Power Management in Desktop Computer
- DC/DC Converters

V_{DSS}	120	V
$R_{DS(ON)-Typ}$	4.2	m Ω
I_D	100	A

Absolute Maximum Ratings ($T_C=25^\circ\text{C}$, Unless Otherwise Noted)

Symbol	Parameter	Rating	Unit
V_{DSS}	Drain-Source Voltage	120	V
V_{GSS}	Gate-Source Voltage	± 20	V
T_J	Maximum Junction Temperature	-55 to 150	$^\circ\text{C}$
T_{STG}	Storage Temperature Range	-55 to 150	$^\circ\text{C}$
EAS	Single Pulse Avalanche Energy ³	245	mJ
$I_{DM}^{①}$	Pulse Drain Current Tested	400	A
I_D	Continuous Drain Current	$T_C=25^\circ\text{C}$	A
P_D	Maximum Power Dissipation	$T_C=25^\circ\text{C}$	W

Thermal Characteristics

Symbol	Parameter	Rating	Unit
$R_{\theta JA}$	Thermal Resistance-Junction to Ambient	57	$^\circ\text{C}/\text{W}$
$R_{\theta JC}$	Thermal Resistance Junction-Case ¹	1.1	$^\circ\text{C}/\text{W}$

Note ① : Max. current is limited by bonding wire.

Note ② : UIS tested and pulse width are limited by maximum junction temperature 150°C .

Note ③ : Surface Mounted on 1in^2 FR-4 board with 1oz.

**N-Channel Enhancement Mode MOSFET****Electrical Characteristics** ($T_J=25^{\circ}\text{C}$, Unless Otherwise Noted)

Symbol	Parameter	Test Conditions	Min	Typ	Max	Unit
Static Electrical Characteristics						
BV_{DSS}	Drain-Source Breakdown Voltage	$V_{GS}=0V, I_D=250\mu A$	120	---	---	V
I_{DSS}	Zero Gate Voltage Drain Current	$V_{DS}=120V, V_{GS}=0V$	---	---	1	μA
$V_{GS(th)}$	Gate Threshold Voltage	$V_{DS}=V_{GS}, I_D=250\mu A$	2.0	3.0	4.0	V
I_{GSS}	Gate Leakage Current	$V_{GS}=\pm 20V, V_{DS}=0V$	---	---	± 100	nA
$R_{DS(on)}$	Drain-Source On-state Resistance	$V_{GS}=10V, I_D=20A$	---	4.2	5.5	m Ω
Dynamic Characteristics ^⑤						
C_{iss}	Input Capacitance	$V_{DS}=60V, V_{GS}=0V, \text{Freq.}=1\text{MHz}$	---	4057	---	pF
C_{oss}	Output Capacitance		---	1005	---	
C_{rss}	Reverse Transfer Capacitance		---	27	---	
$T_{d(on)}$	Turn-on Delay Time	$V_{DS}=15V, V_{GS}=10V, I_D=20A, R_G=3\Omega$	---	19	---	nS
T_r	Turn-on Rise Time		---	18	---	
$T_{d(off)}$	Turn-off Delay Time		---	36.5	---	
T_f	Turn-off Fall Time		---	17	---	
Q_g	Total Gate Charge	$V_{DS}=60V, V_{GS}=10V, I_D=20A$	---	67	---	nC
Q_{gs}	Gate-Source Charge		---	17.7	---	
Q_{gd}	Gate-Drain Charge		---	17	---	
Source-Drain Characteristics						
V_{SD}	Diode Forward Voltage	$I_S=20A, V_{GS}=0V$	---	---	1.2	V

Note ④: Pulse test (pulse width $\leq 300\mu s$, duty cycle $\leq 2\%$).

Note ⑤: Guaranteed by design, not subject to production testing.

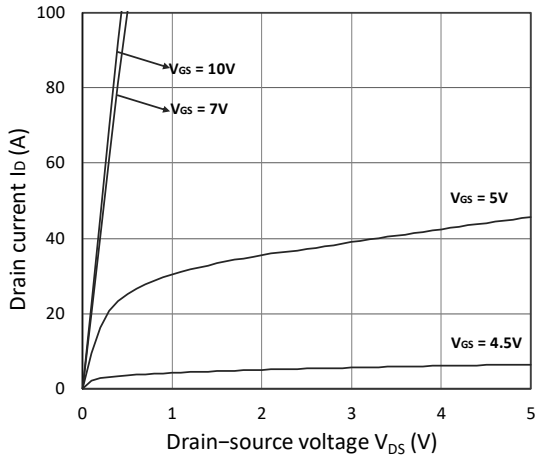
N-Channel Enhancement Mode MOSFET
Typical Characteristics


Figure 1. Output Characteristics

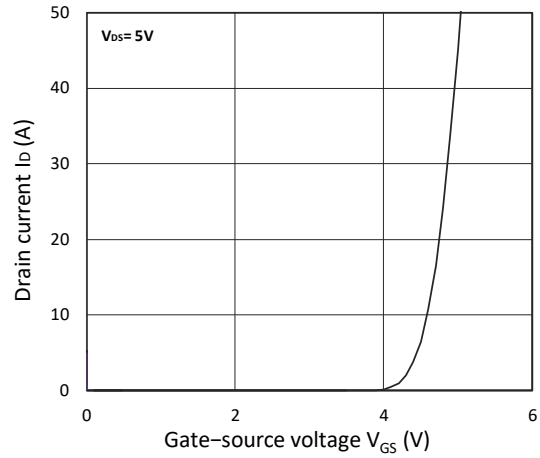


Figure 2. Transfer Characteristics

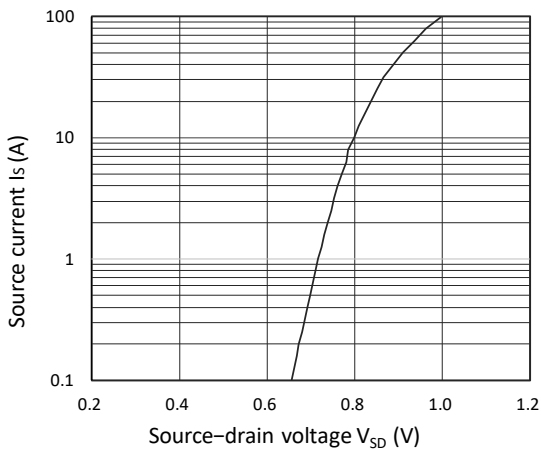
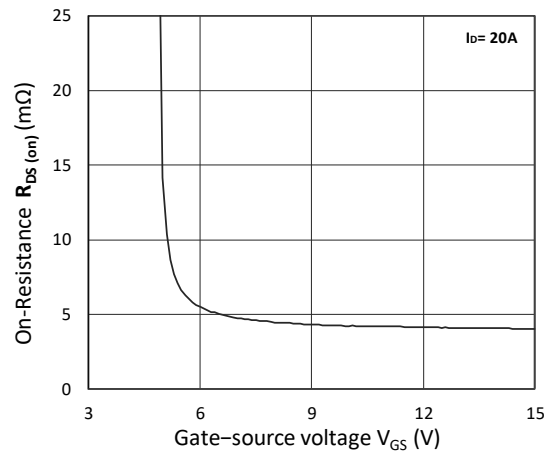
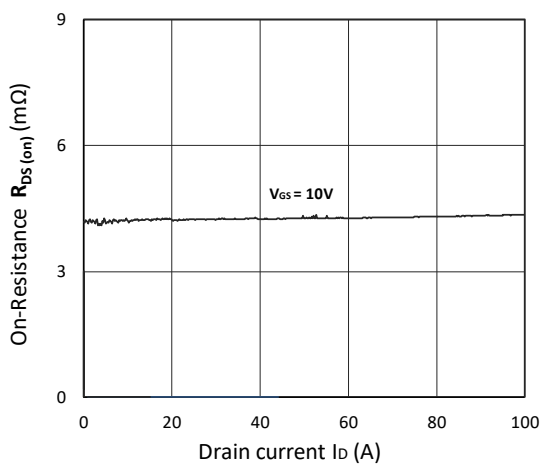
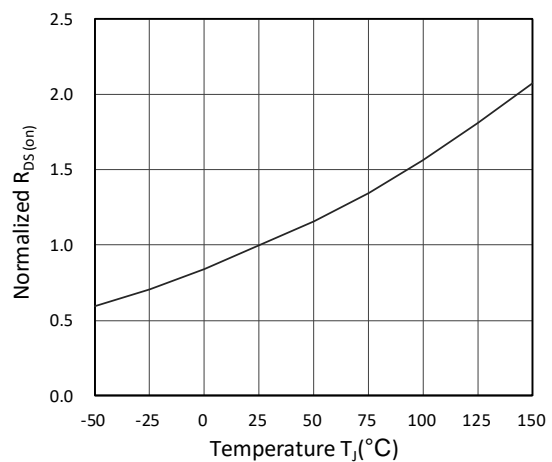


Figure 3. Forward Characteristics of Reverse


 Figure 4. $R_{DS(on)}$ vs. V_{GS}

 Figure 5. $R_{DS(on)}$ vs. I_D

 Figure 6. Normalized $R_{DS(on)}$ vs. Temperature

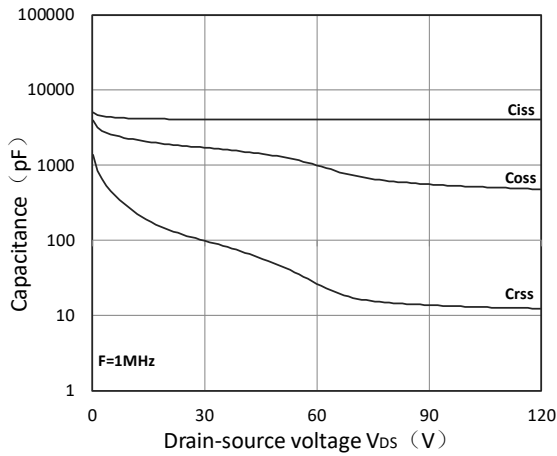
N-Channel Enhancement Mode MOSFET


Figure 7. Capacitance Characteristics

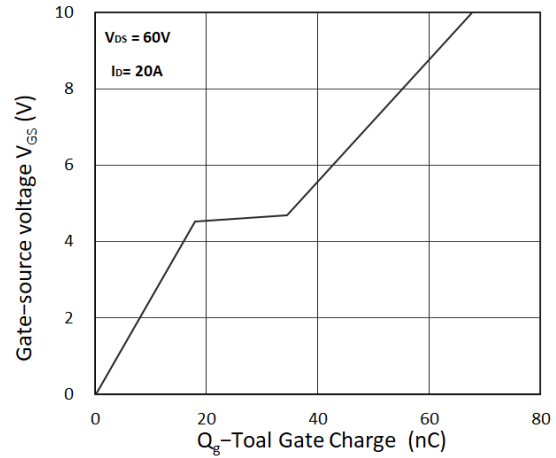


Figure 8. Gate Charge Characteristics

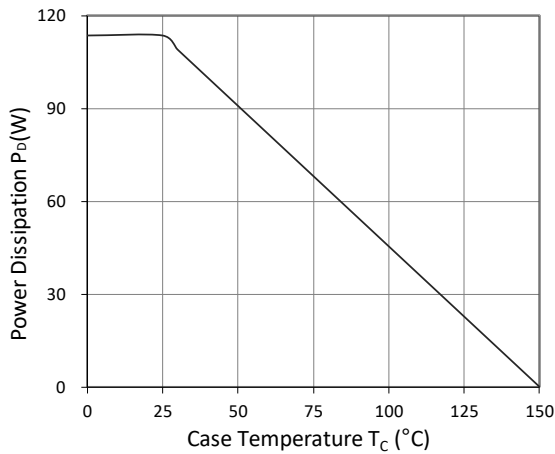


Figure 9. Power Dissipation

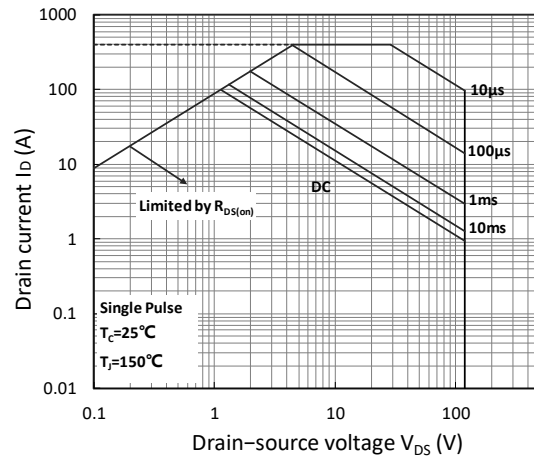


Figure10. Safe Operating Area

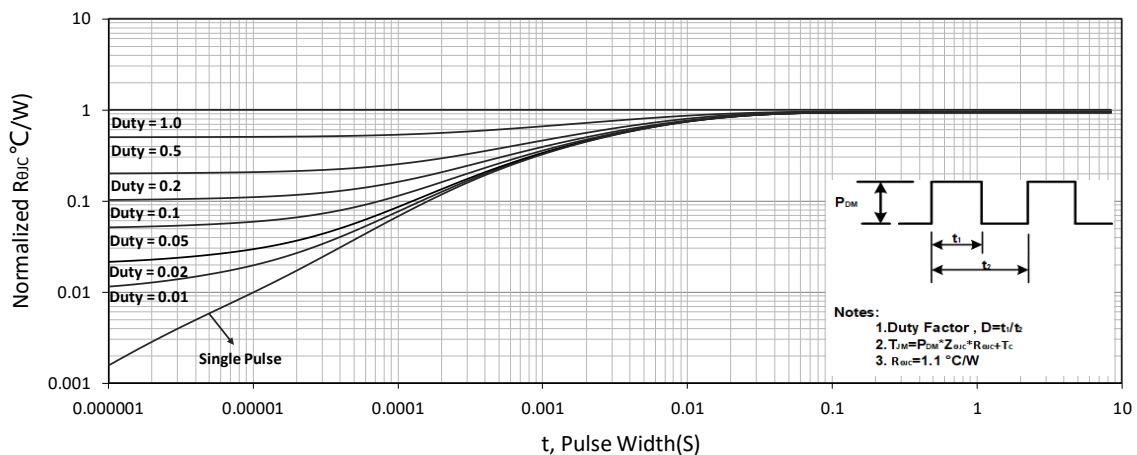
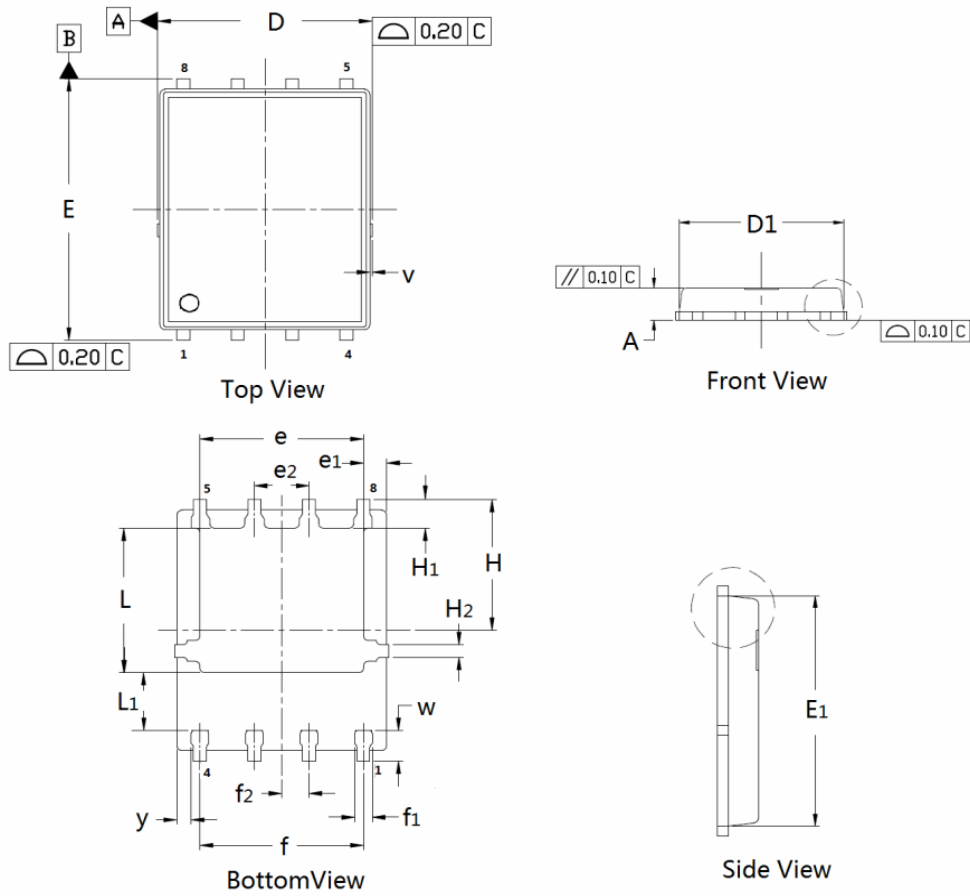


Figure 11. Normalized Maximum Transient Thermal Impedance

N-Channel Enhancement Mode MOSFET
DFN5×6 Package Outline Data

DIMENSIONS (unit : mm)

Symbol	Min	Typ	Max	Symbol	Min	Typ	Max
A	0.90	1.02	1.10	D	4.90	4.98	5.10
D ₁	4.80	4.89	5.10	E	5.90	6.11	6.25
E ₁	5.65	5.74	5.95	e	3.72	3.80	3.92
e ₁	--	0.5	--	e ₂	--	1.	--
f	--	3.8	--	f ₁	0.31	0.37	0.51
f ₂	--	0.6	--	H	--	3.	--
H ₁	0.59	0.63	0.79	H ₂	0.26	0.28	0.32
L	3.35	3.45	3.65	L ₁	--	1.	--
v	--	0.1	--	w	0.64	0.68	0.84
y	--	0.3	--		--		--