

## N-Channel Enhancement Mode MOSFET

### Features

- High Speed Power Switching
- Reliable and Rugged
- ROHS Compliant
- 100% Avalanche Tested

### Applications

- Power Management in Desktop Computer
- DC/DC Converters

### Pin Description

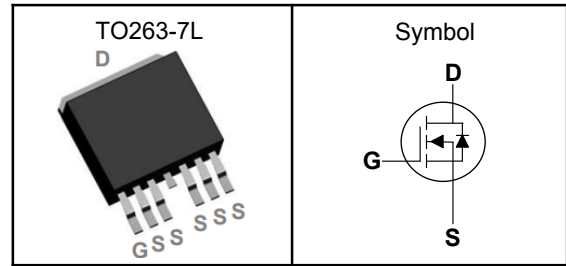

$V_{DSS}$	100	V
$R_{DS(ON)-Typ}$	1.1	m $\Omega$
$I_D$	300	A

### Absolute Maximum Ratings ( $T_C=25^\circ\text{C}$ , Unless Otherwise Noted)

Symbol	Parameter	N-Channel	Unit
$V_{DSS}$	Drain-Source Voltage	100	V
$V_{GSS}$	Gate-Source Voltage	$\pm 20$	V
$T_J$	Maximum Junction Temperature	-55 to 175	$^\circ\text{C}$
$T_{STG}$	Storage Temperature Range	-55 to 175	$^\circ\text{C}$
$I_{DM}^{①}$	Pulse Drain Current Tested	1200	A
$I_D$	Continuous Drain Current	300	A
$P_D$	Maximum Power Dissipation	500	W
$E_{AS}$	Avalanche Energy, Single pulse	2800	mJ

### Thermal Characteristics

Symbol	Parameter	Rating	Unit
$R_{\theta JA}$	Thermal Resistance-Junction to Ambient	40	$^\circ\text{C}/\text{W}$
$R_{\theta JC}$	Thermal Resistance-Junction to Case	0.55	$^\circ\text{C}/\text{W}$

Note ① : Max. current is limited by bonding wire.

Note ② : UIS tested and pulse width are limited by maximum junction temperature 150 $^\circ\text{C}$ .

Note ③ : Surface Mounted on 1in<sup>2</sup> FR-4 board with 1oz.



**N-Channel Enhancement Mode MOSFET**

**Electrical Characteristics** ( $T_J=25^{\circ}\text{C}$ , Unless Otherwise Noted)

Symbol	Parameter	Test Conditions	Min	Typ	Max	Unit
<b>Static Electrical Characteristics</b>						
$BV_{DSS}$	Drain-Source Breakdown Voltage	$V_{GS}=0V, I_D=250\mu A$	100	---	---	V
$I_{DSS}$	Zero Gate Voltage Drain Current	$V_{DS}=80V, V_{GS}=0V$	---	---	1	$\mu A$
$V_{GS(th)}$	Gate Threshold Voltage	$V_{DS}=V_{GS}, I_D=250\mu A$	2	---	4	V
$I_{GSS}$	Gate Leakage Current	$V_{GS}=\pm 20V, V_{DS}=0V$	---	---	$\pm 100$	nA
$R_{DS(on)}$	Drain-Source On-state Resistance	$V_{GS}=10V, I_D=50A$	---	1.1	1.3	$m\Omega$
		$V_{GS}=6V, I_D=25A$	---	1.5	1.9	$m\Omega$
<b>Dynamic Characteristics</b> <sup>⑤</sup>						
$C_{iss}$	Input Capacitance	$V_{DS}=50V, V_{GS}=0V, \text{Freq.}=1\text{MHz}$	---	11876	---	pF
$C_{oss}$	Output Capacitance		---	2041	---	
$C_{riss}$	Reverse Transfer Capacitance		---	106	---	
$T_{d(on)}$	Turn-on Delay Time	$V_{DS}=50V, V_{GS}=10V, I_D=50A, R_G=4.5\Omega$	---	29	---	nS
$T_r$	Turn-on Rise Time		---	121	---	
$T_{d(off)}$	Turn-off Delay Time		---	198	---	
$T_f$	Turn-off Fall Time		---	175	---	
$Q_g$	Total Gate Charge	$V_{DS}=50V, V_{GS}=10V, I_D=50A$	---	168	---	nC
$Q_{gs}$	Gate-Source Charge		---	46	---	
$Q_{gd}$	Gate-Drain Charge		---	67	---	
<b>Source-Drain Characteristics</b>						
$V_{SD}$	Diode Forward Voltage	$I_S=50A, V_{GS}=0V$	---	---	1.3	V
$t_{rr}$	Reverse Recovery Time	$I_F=50A, V_{GS}=0V, di_F/dt=100A/\mu s$	---	137	---	nS
$Q_{rr}$	Reverse Recovery Charge		---	347	---	nC

Note ④: Pulse test (pulse width $\leq 300\mu s$ , duty cycle $\leq 2\%$ ).

Note ⑤: Guaranteed by design, not subject to production testing.



N-Channel Enhancement Mode MOSFET

Typical Characteristics

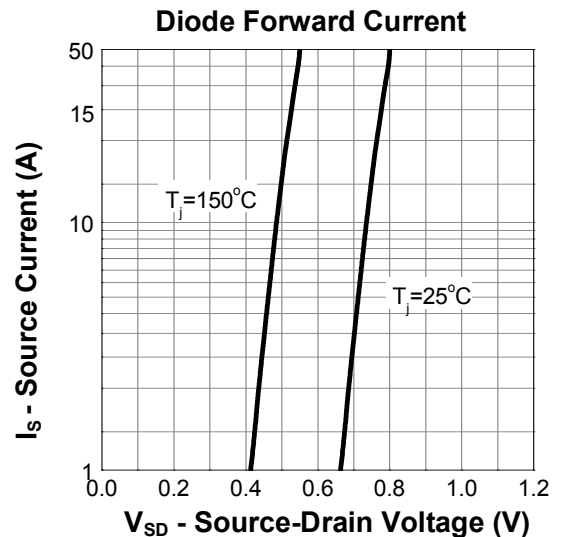
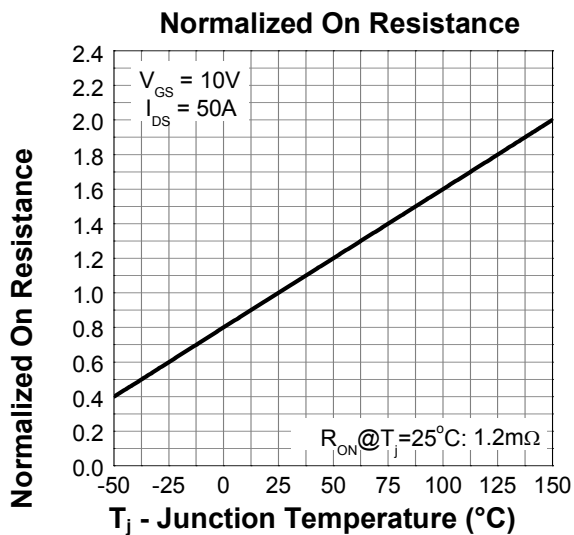
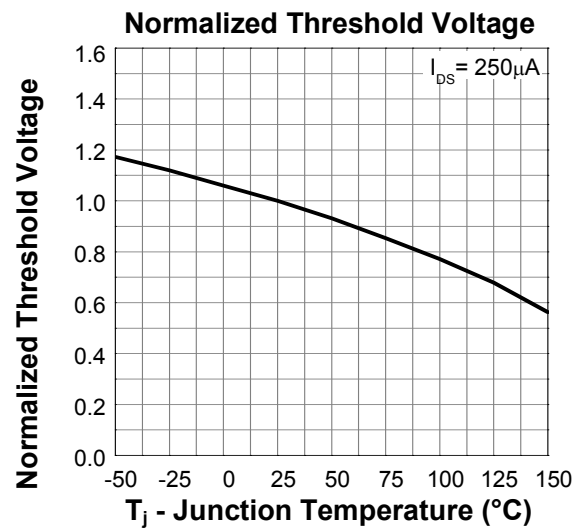
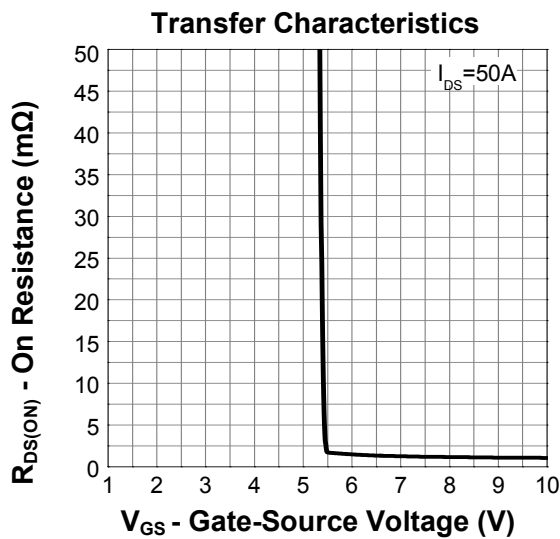
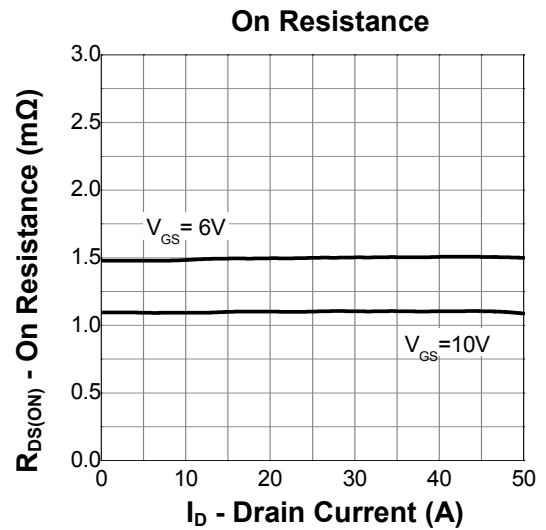
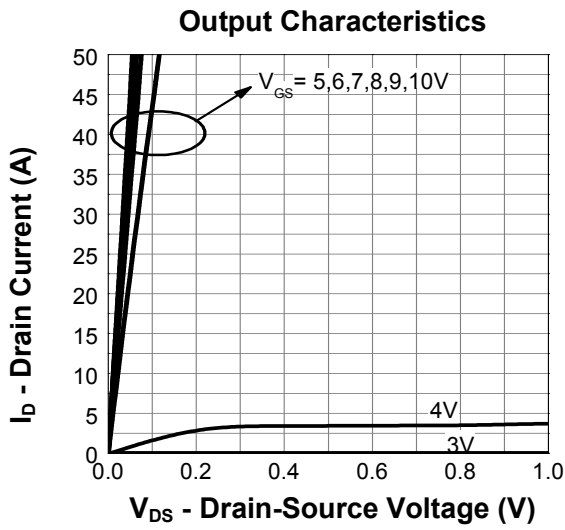



**N-Channel Enhancement Mode MOSFET**

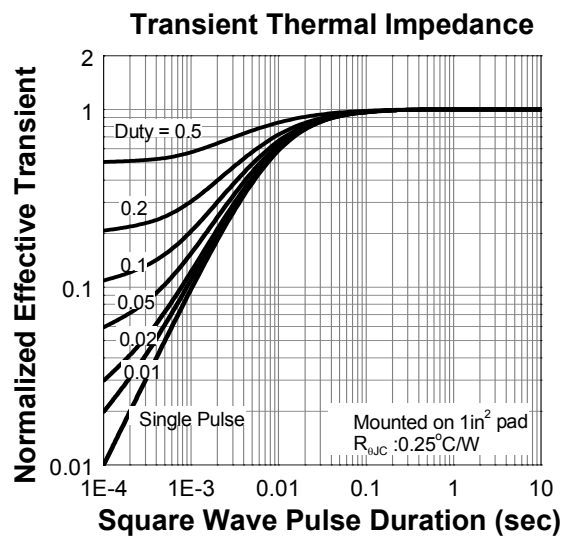
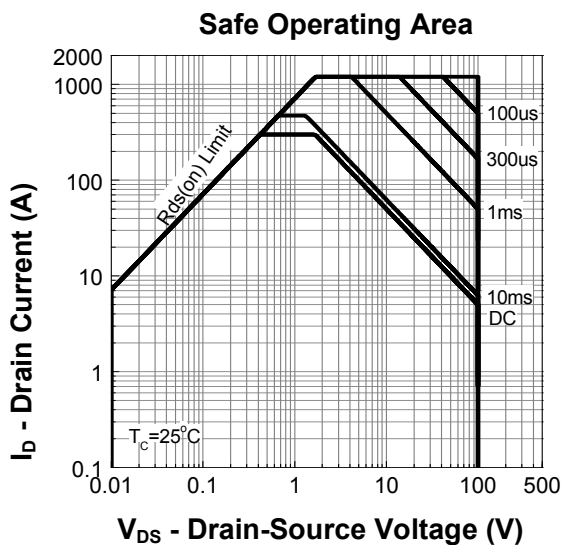
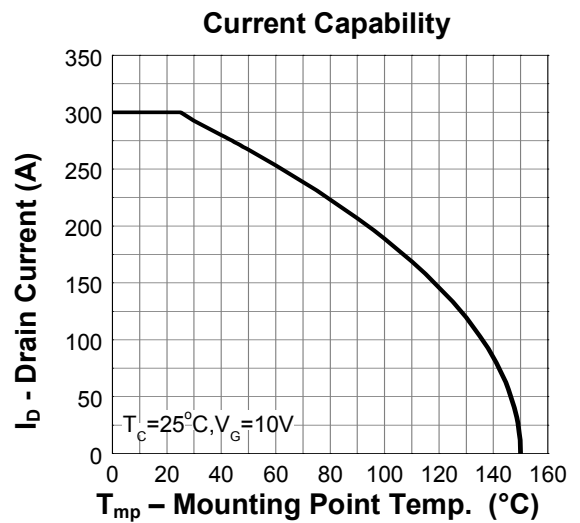
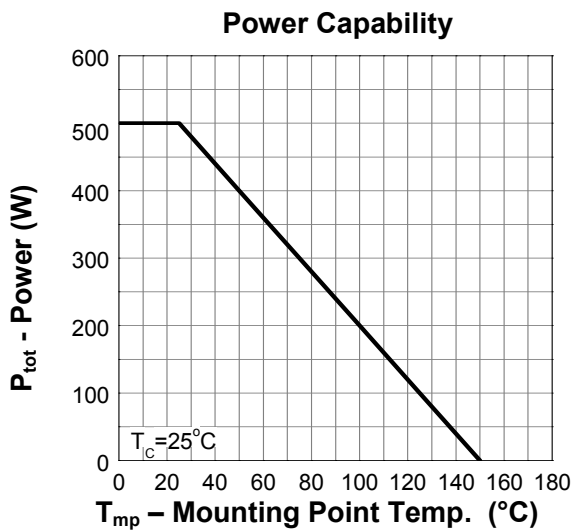
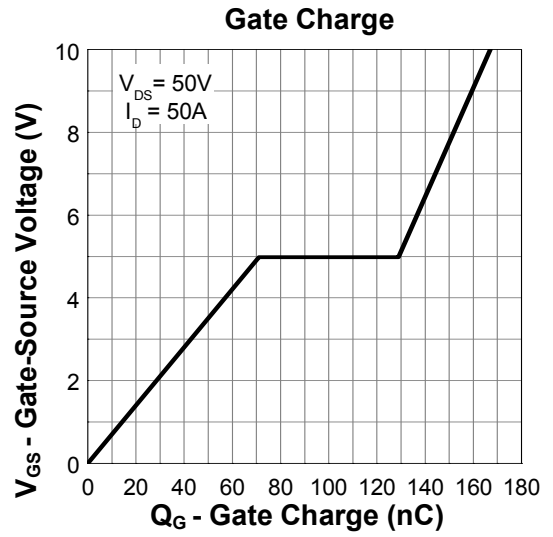
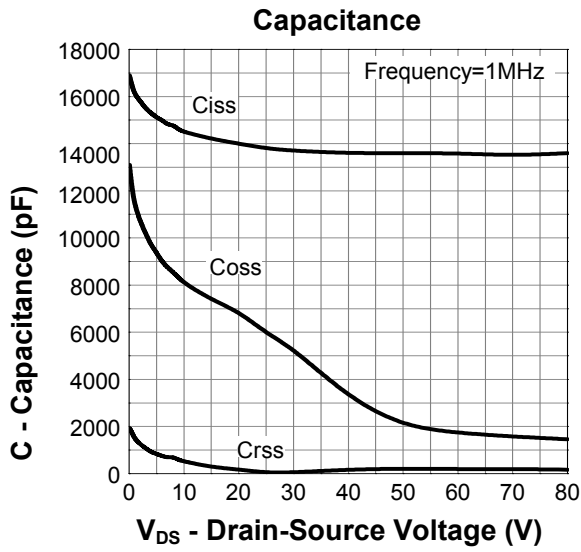

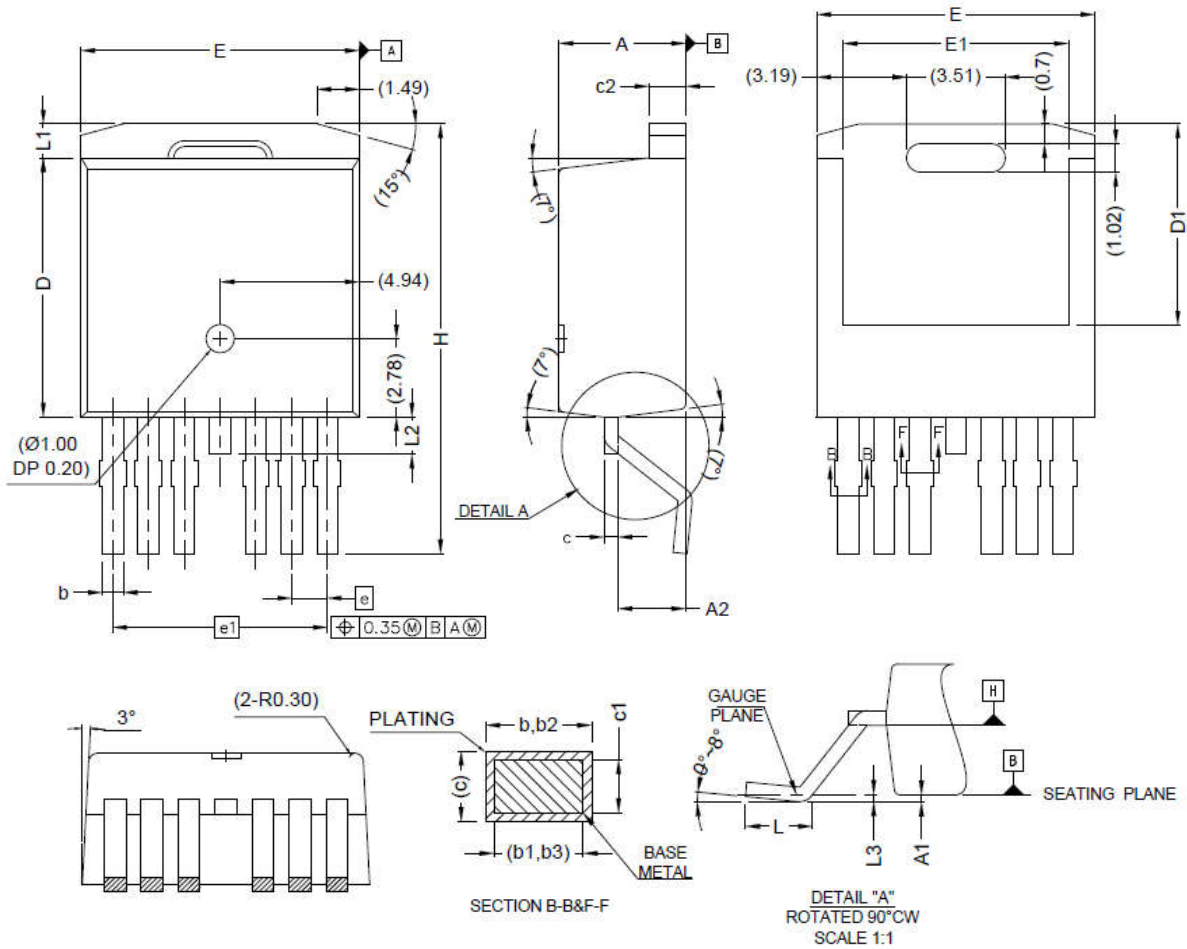
**N-Channel Enhancement Mode MOSFET**
**TO263-7L Package Outline Data**

SYMBOL	MIN	MAX
A	4.30	4.70
A1	-	0.25
A2	2.20	2.60
b	0.65	0.85
b1	0.65	0.80
b2	0.80	1.00
b3	0.80	0.95
c	0.45	0.60
c1	0.45	0.55
c2	1.25	1.40
D	9.00	9.40
D1	6.86	7.42
E	9.68	10.08
E1	7.70	8.30
e	1.27 BSC	
e1	7.62 BSC	
L	1.78	2.79
L1	-	1.60
L2	-	1.78
L3	0.25BSC	
H	14.61	15.88