

N-Channel Enhancement Mode MOSFET

Features

- Low $R_{ds(on)}$ for low conduction loss
- Reliable and Rugged
- ROHS Compliant & Halogen-Free

Pin Description

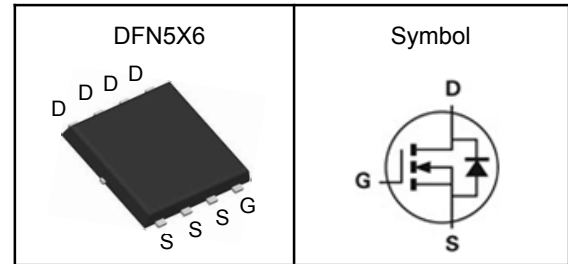

Applications

- Power Management in Desktop Computer
- DC/DC Converters

V_{DSS}	40	V
$R_{DS(ON)-Typ}$	3.2	m Ω
I_D	95	A

Absolute Maximum Ratings ($T_C=25^\circ\text{C}$, Unless Otherwise Noted)

Symbol	Parameter	N-Channel	Unit
V_{DSS}	Drain-Source Voltage	40	V
V_{GSS}	Gate-Source Voltage	± 20	V
T_J	Maximum Junction Temperature	-55 to 150	$^\circ\text{C}$
T_{STG}	Storage Temperature Range	-55 to 150	$^\circ\text{C}$
$I_{DM}^{(1)}$	Pulse Drain Current Tested	141	A
I_D	Continuous Drain Current	$T_C=25^\circ\text{C}$	95
		$T_C=100^\circ\text{C}$	60
P_D	Maximum Power Dissipation	$T_C=25^\circ\text{C}$	50
$E_{AS}^{(2)}$	Avalanche Energy, Single pulse		11.25

Thermal Characteristics

Symbol	Parameter	Rating	Unit
$R_{\theta JA}^{(3)}$	Thermal Resistance-Junction to Ambient	50	$^\circ\text{C}/\text{W}$
$R_{\theta JC}$	Thermal Resistance-Junction to Case	2.5	$^\circ\text{C}/\text{W}$

Note ① : Max. current is limited by bonding wire.

Note ② : UIS tested and pulse width are limited by maximum junction temperature 150°C .

Note ③ : Surface Mounted on 1in^2 FR-4 board with 1oz.



N-Channel Enhancement Mode MOSFET

Electrical Characteristics ($T_J=25^{\circ}\text{C}$, Unless Otherwise Noted)

Symbol	Parameter	Test Conditions	Min	Typ	Max	Unit
Static Electrical Characteristics						
BV_{DSS}	Drain-Source Breakdown Voltage	$V_{GS}=0V, I_D=250\mu A$	40	---	---	V
I_{DSS}	Zero Gate Voltage Drain Current	$V_{DS}=32V, V_{GS}=0V$	---	---	1	μA
$V_{GS(th)}$	Gate Threshold Voltage	$V_{DS}=V_{GS}, I_D=250\mu A$	2.0	---	4.0	V
I_{GSS}	Gate Leakage Current	$V_{GS}=\pm 20V, V_{DS}=0V$	---	---	± 100	nA
$R_{DS(ON)}$	Drain-Source On-state Resistance	$V_{GS}=10V, I_D=20A$	---	3.2	3.8	m Ω
		$V_{DS}=5V, I_D=18A$	---	2.9	---	Ω
Dynamic Characteristics^⑤						
C_{iss}	Input Capacitance	$V_{GS}=0V, V_{DS}=20V, \text{Freq.}=1\text{MHz}$	---	3183	---	pF
C_{oss}	Output Capacitance		---	305	---	
C_{rSS}	Reverse Transfer Capacitance		---	183	---	
$T_{d(on)}$	Turn-on Delay Time	$V_{DD}=15V, V_{GS}=10V, R_G=1\Omega, I_D=1A$	---	28	---	nS
T_r	Turn-on Rise Time		---	21	---	
$T_{d(off)}$	Turn-off Delay Time		---	38	---	
T_f	Turn-off Fall Time		---	19	---	
Q_g	Total Gate Charge	$V_{DS}=25V, V_{GS}=10V, I_D=14A$	---	53.4	---	nC
Q_{gs}	Gate-Source Charge		---	11.8	---	
Q_{gd}	Gate-Drain Charge		---	16.3	---	
Source-Drain Characteristics						
$V_{SD}^{④}$	Diode Forward Voltage	$I_S=15A, V_{GS}=0V$	---	0.8	1.1	V
T_{rr}	Reverse Recovery Time	$I_F=15A, V_{GS}=0V, di/dt=100A/\mu s, T_J=25^{\circ}\text{C}$	---	19.1	---	nS
Q_{rr}	Reverse Recovery Charge		---	10.4	---	nC

Note ④ : Pulse test (pulse width \leq 300us, duty cycle \leq 2%).

Note ⑤ : Guaranteed by design, not subject to production testing.

N-Channel Enhancement Mode MOSFET

Typical Characteristics

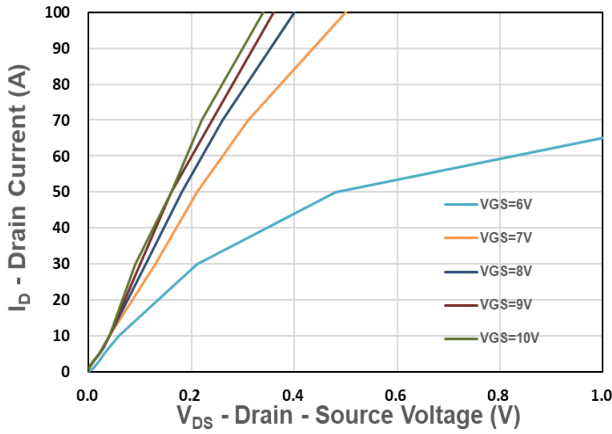
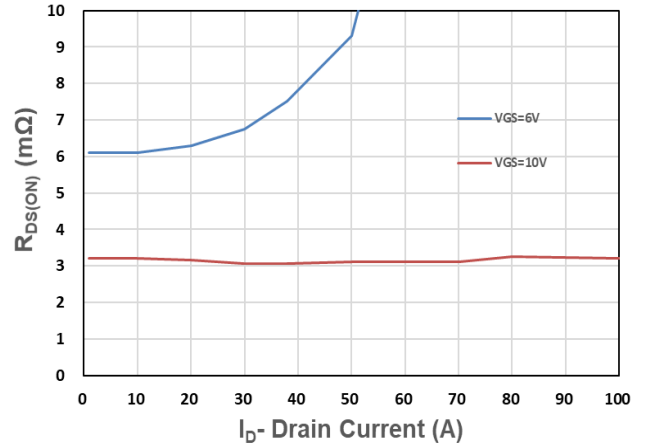
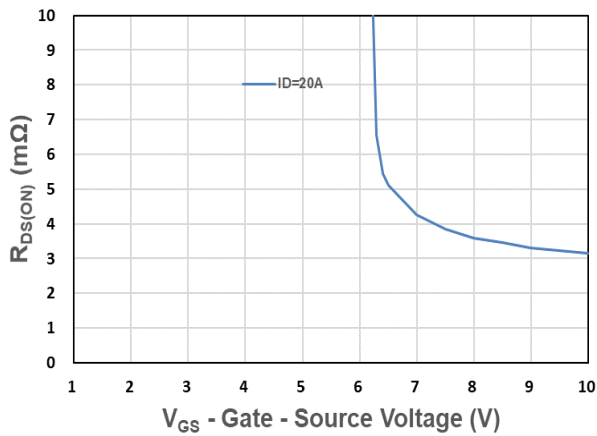
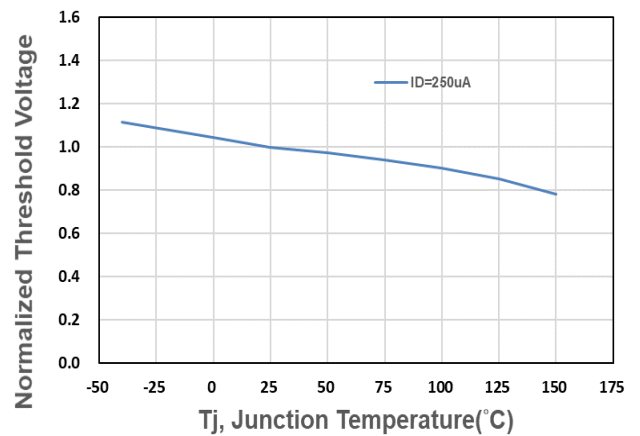
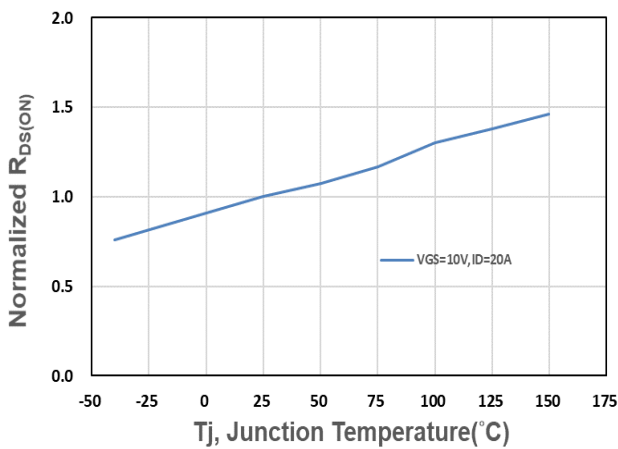
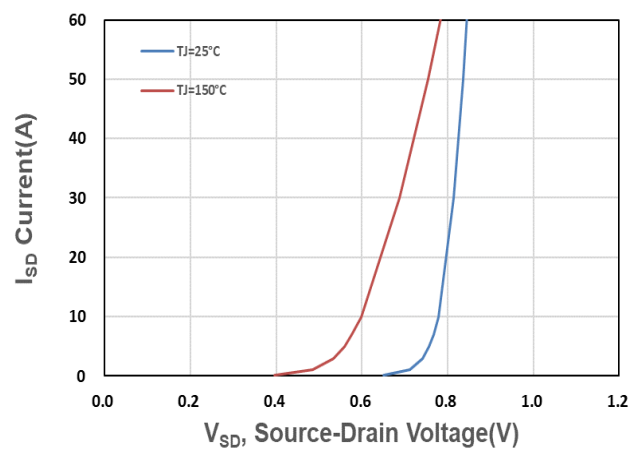
Figure 1. Output Characteristics

Figure 2. On-Resistance vs. I_D

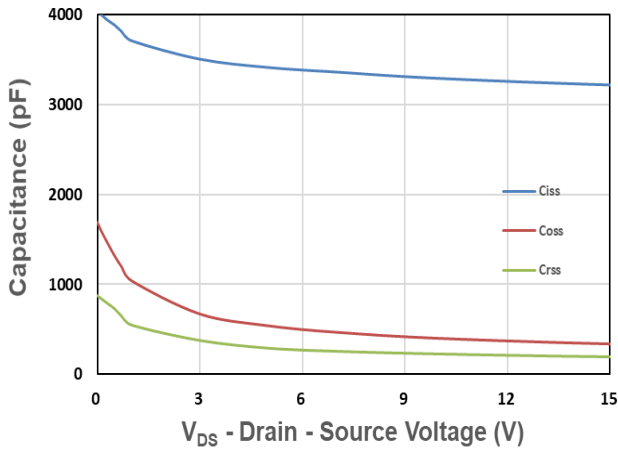
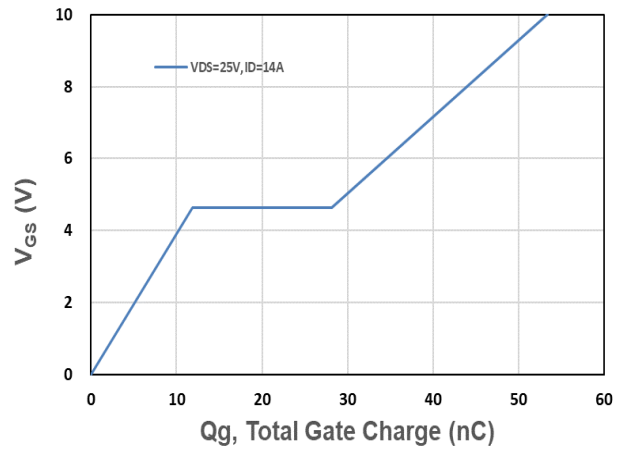
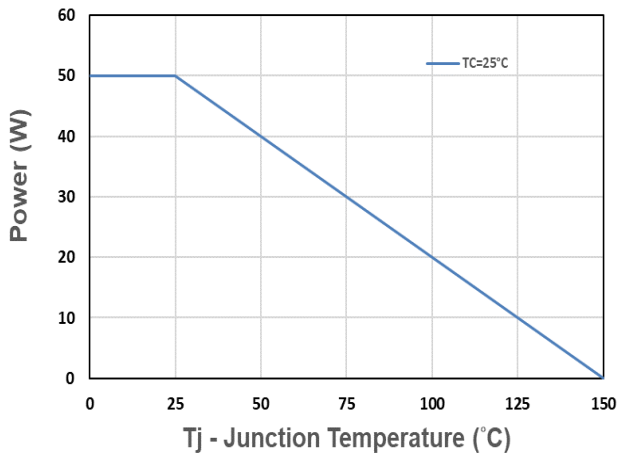
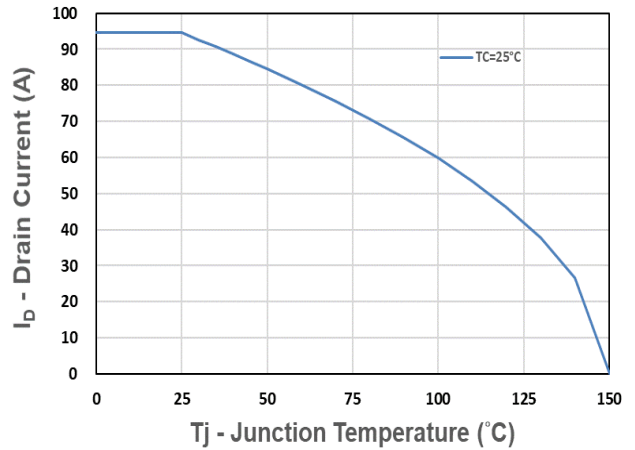
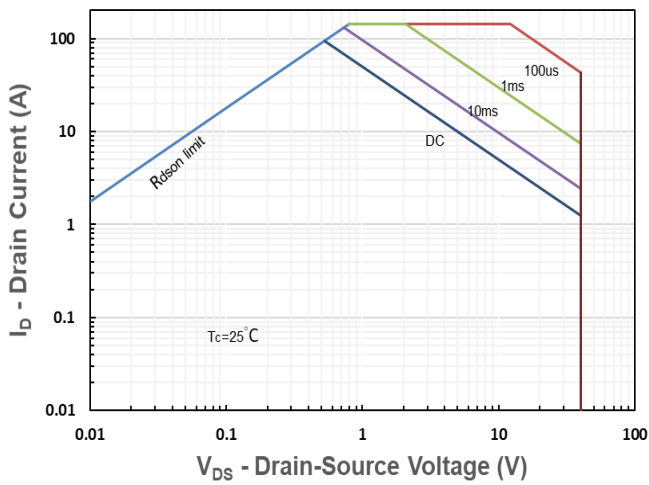
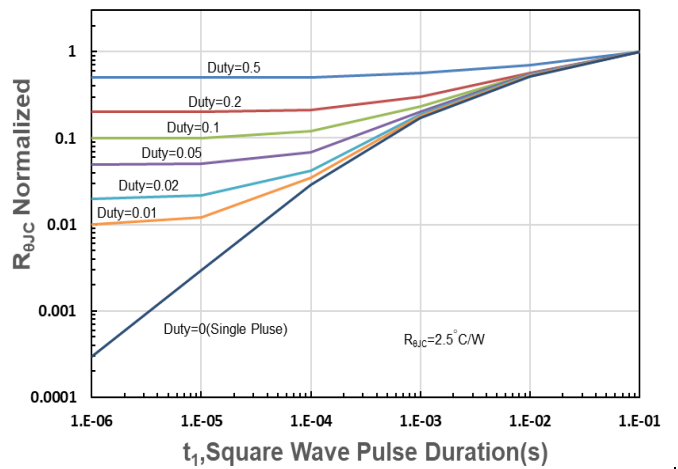
Figure 3. On-Resistance vs. V_{GS}

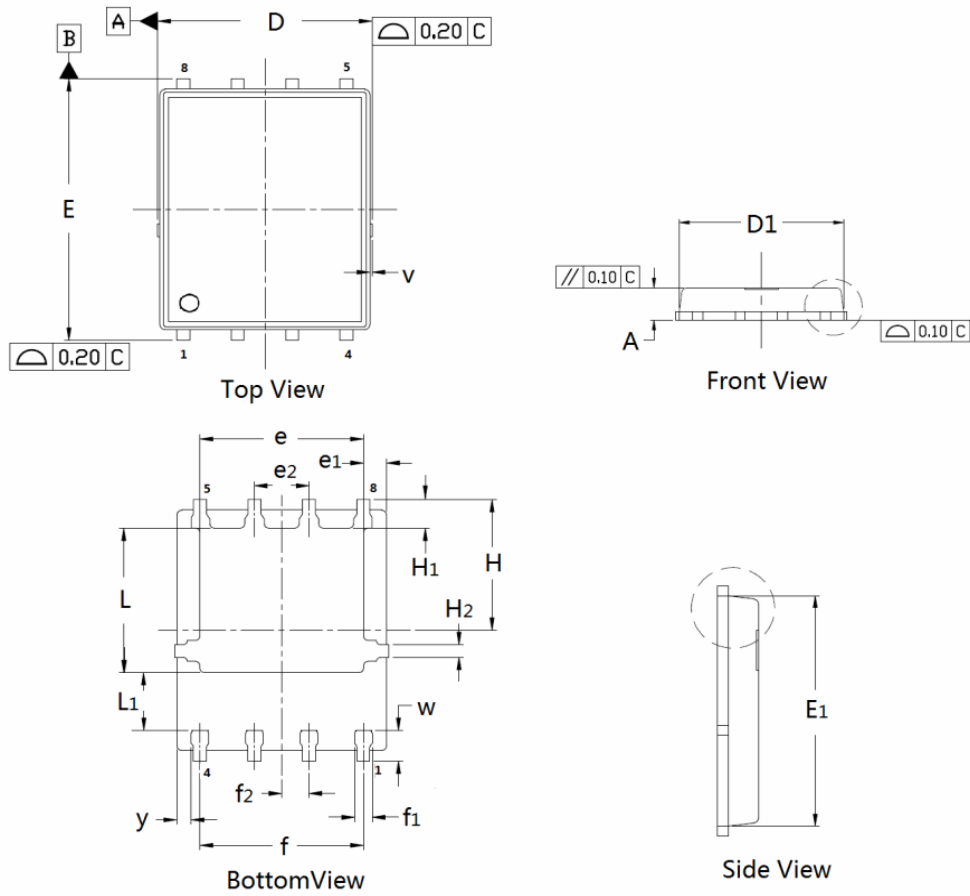
Figure 4. Gate Threshold Voltage

Figure 5. Drain-Source On Resistance

Figure 6. Source-Drain Diode Forward

N-Channel Enhancement Mode MOSFET

Figure 7. Capacitance

Figure 8. Gate Charge Characteristics

Figure 9. Power Dissipation

Figure 10. Drain Current

Figure 11. Safe Operating Area

Figure 12. $R_{\theta JC}$ Transient Thermal Impedance

N-Channel Enhancement Mode MOSFET
DFN5×6 Package Outline Data

DIMENSIONS (unit : mm)

Symbol	Min	Typ	Max	Symbol	Min	Typ	Max
A	0.90	1.02	1.10	D	4.90	4.98	5.10
D ₁	4.80	4.89	5.10	E	5.90	6.11	6.25
E ₁	5.65	5.74	5.95	e	3.72	3.80	3.92
e ₁	--	0.5	--	e ₂	--	1.	--
f	--	3.8	--	f ₁	0.31	0.37	0.51
f ₂	--	0.6	--	H	--	3.	--
H ₁	0.59	0.63	0.79	H ₂	0.26	0.28	0.32
L	3.35	3.45	3.65	L ₁	--	1.	--
v	--	0.1	--	w	0.64	0.68	0.84
y	--	0.3	--				