

## P-Channel Enhancement Mode MOSFET

### Features

- Low  $R_{ds(on)}$  for low conduction loss
- Reliable and Rugged
- ROHS Compliant & Halogen-Free

### Applications

- Power Management in Desktop Computer
- DC/DC Converters

### Pin Description

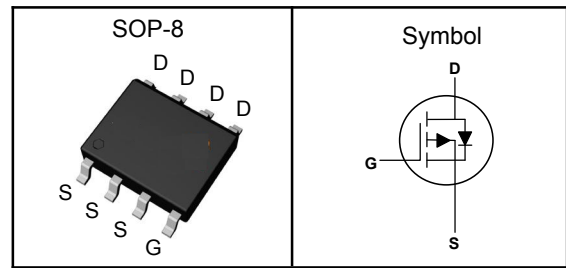

$V_{DSS}$	-30	V
$R_{DS(ON)-Typ}$	16	m $\Omega$
$I_D$	-9.1	A

### Absolute Maximum Ratings ( $T_A=25^\circ\text{C}$ , Unless Otherwise Noted)

Symbol	Parameter	P-Channel	Unit
$V_{DSS}$	Drain-Source Voltage	-30	V
$V_{GSS}$	Gate-Source Voltage	$\pm 20$	V
$T_J$	Maximum Junction Temperature	-55 to 150	$^\circ\text{C}$
$T_{STG}$	Storage Temperature Range	-55 to 150	$^\circ\text{C}$
$I_{DM}^{①}$	Pulse Drain Current Tested	-50	A
$I_D$	Continuous Drain Current	-9.1	A
$P_D$	Maximum Power Dissipation	$T_A=25^\circ\text{C}$ 3.1	W

### Thermal Characteristics

Symbol	Parameter	Rating	Unit
$R_{\theta JA}^{③}$	Thermal Resistance-Junction to Ambient	40	$^\circ\text{C}/\text{W}$

Note ① : Max. current is limited by bonding wire.

Note ② : UIS tested and pulse width are limited by maximum junction temperature  $150^\circ\text{C}$ .

Note ③ : Surface Mounted on  $1\text{in}^2$  FR-4 board with 1oz.

**P-Channel Enhancement Mode MOSFET****Electrical Characteristics** ( $T_J=25^\circ\text{C}$ , Unless Otherwise Noted)

Symbol	Parameter	Test Conditions	Min	Typ	Max	Unit
<b>Static Electrical Characteristics</b>						
$BV_{DSS}$	Drain-Source Breakdown Voltage	$V_{GS}=0V, I_D=-250\mu A$	-30	---	---	V
$I_{DSS}$	Zero Gate Voltage Drain Current	$V_{DS}=-30V, V_{GS}=0V$	---	---	-1	$\mu A$
$V_{GS(th)}$	Gate Threshold Voltage	$V_{DS}=V_{GS}, I_D=-250\mu A$	-1	---	-3	V
$I_{GSS}$	Gate Leakage Current	$V_{GS}=\pm 20V, V_{DS}=0V$	---	---	$\pm 100$	nA
$R_{DS(on)}$	Drain-Source On-state Resistance	$V_{GS}=-10V, I_D=-9.1A$	---	16	20	$m\Omega$
		$V_{GS}=-4.5V, I_D=-6.9A$	---	21	35	$m\Omega$
gfs	Forward Transconductance	$V_{DS}=-15V, I_D=-9.1A$	10	---	---	S
<b>Dynamic Characteristics</b> <sup>⑤</sup>						
$C_{iss}$	Input Capacitance	$V_{GS}=0V,$ $V_{DS}=-15V,$ Freq.=1MHz	---	1600	---	pF
$C_{oss}$	Output Capacitance		---	350	---	
$C_{rss}$	Reverse Transfer Capacitance		---	300	---	
$T_{d(on)}$	Turn-on Delay Time	$V_{DD}=-15V, I_D=-1A,$ $V_{GS}=-10V, R_G=6\Omega$	---	10	---	nS
$T_r$	Turn-on Rise Time		---	15	---	
$T_{d(off)}$	Turn-off Delay Time		---	110	---	
$T_f$	Turn-off Fall Time		---	70	---	
$Q_g$	Total Gate Charge	$V_{DS}=-10V, V_{GS}=-10V,$ $I_D=-9.1A$	---	30	---	nC
$Q_{gs}$	Gate-Source Charge		---	5.5	---	
$Q_{gd}$	Gate-Drain Charge		---	8	---	
<b>Source-Drain Characteristics</b> ( $T_J=25^\circ\text{C}$ )						
$V_{SD}$ <sup>④</sup>	Diode Forward Voltage	$V_{GS}=0V, I_S=-9.1A, T_J=25^\circ\text{C}$	---	---	-1.2	V

Note ④ : Pulse test (pulse width $\leq 300\mu s$ , duty cycle $\leq 2\%$ ).

Note ⑤ : Guaranteed by design, not subject to production testing.

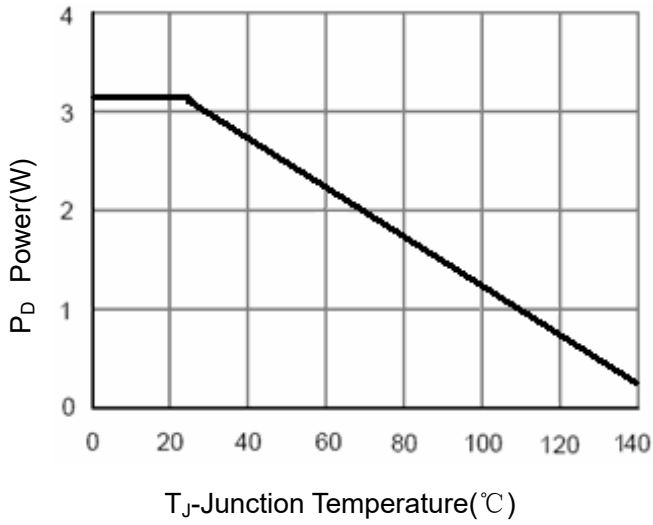
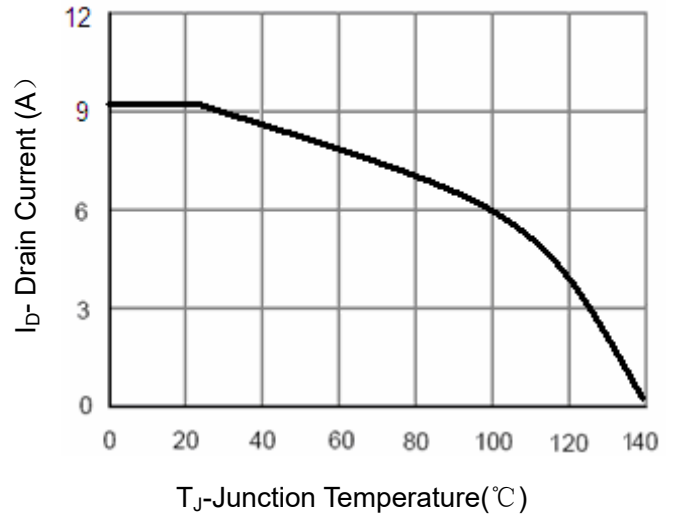
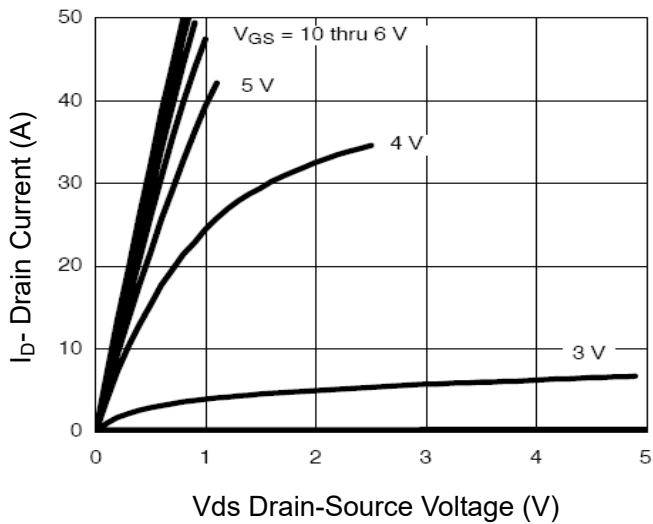
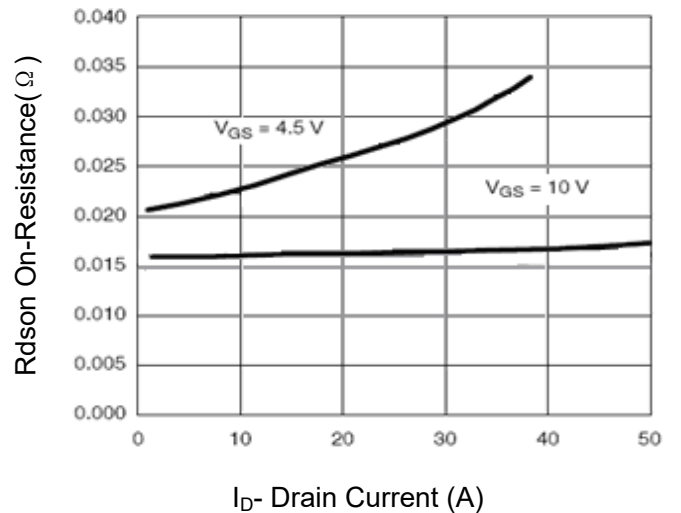
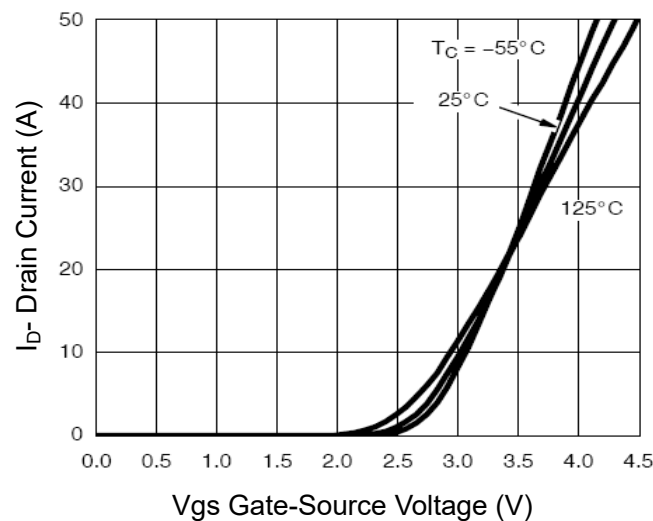
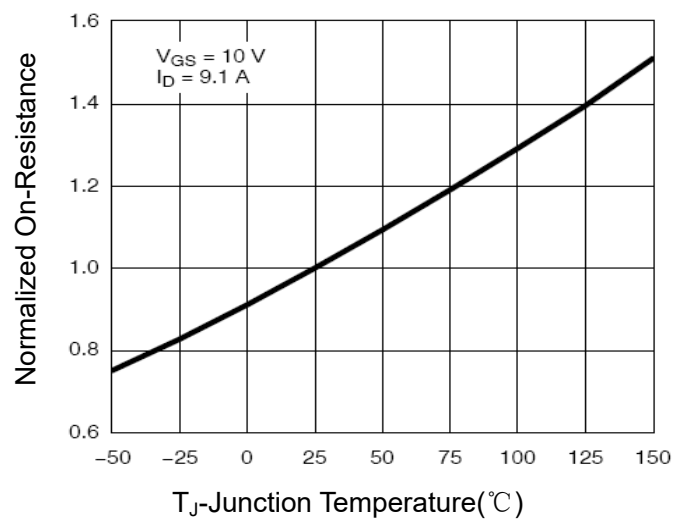
**P-Channel Enhancement Mode MOSFET**
**Typical Characteristics**

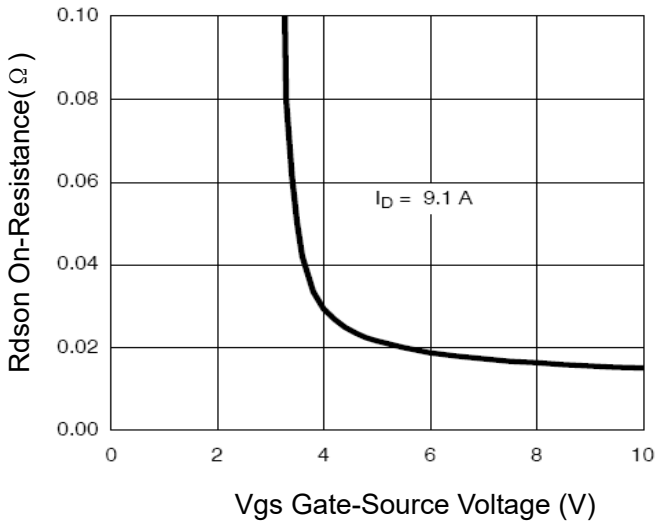
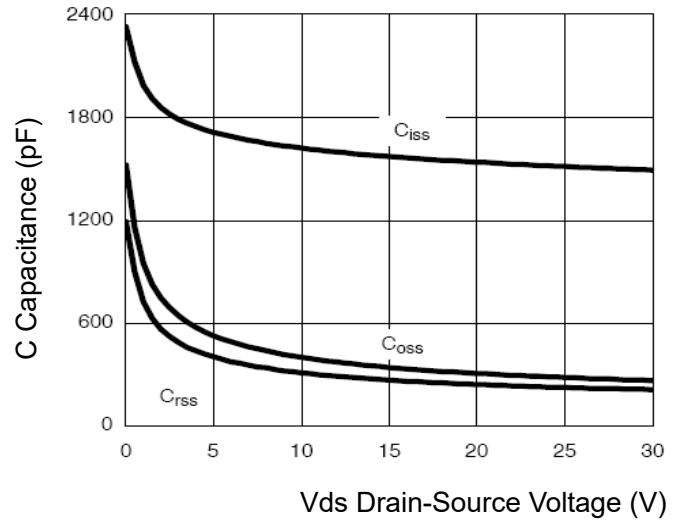
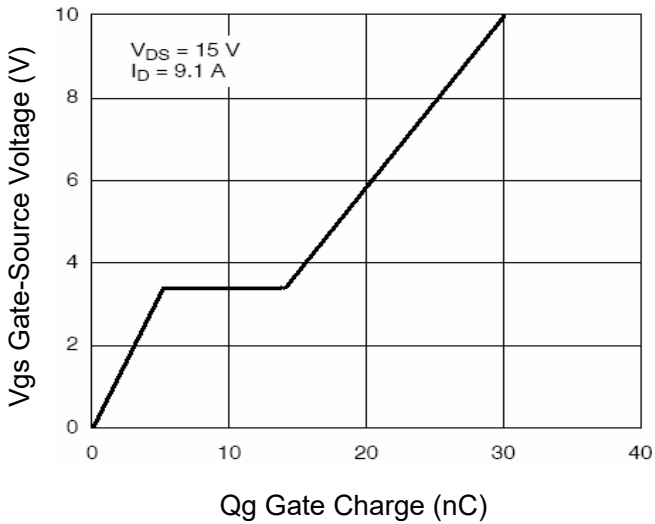
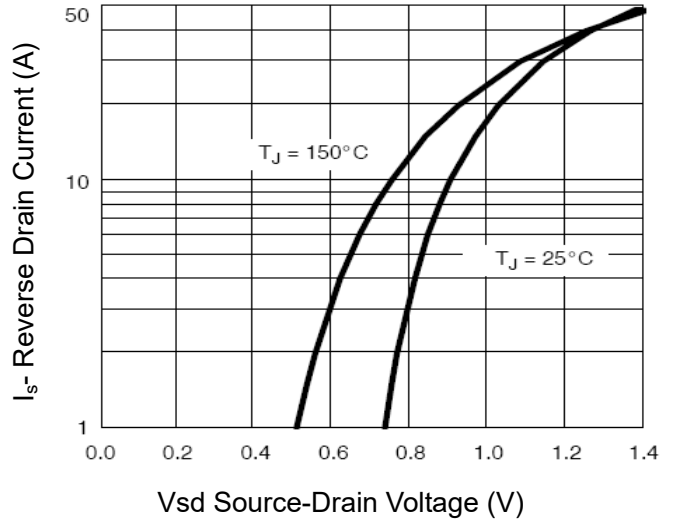
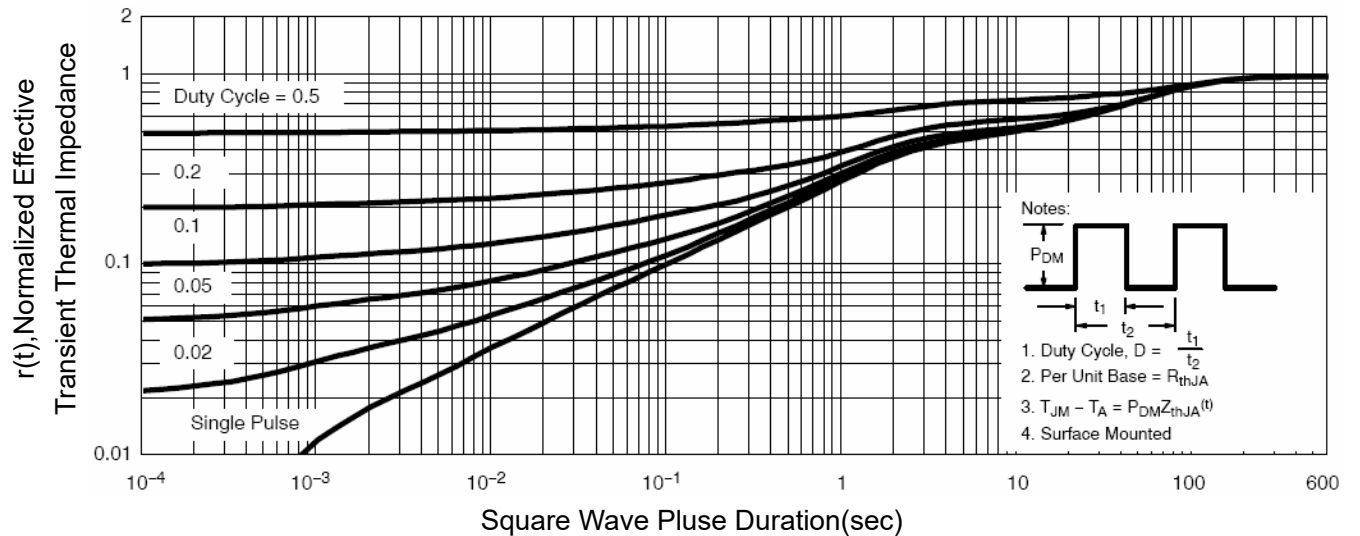
**Figure 1 Power Dissipation**

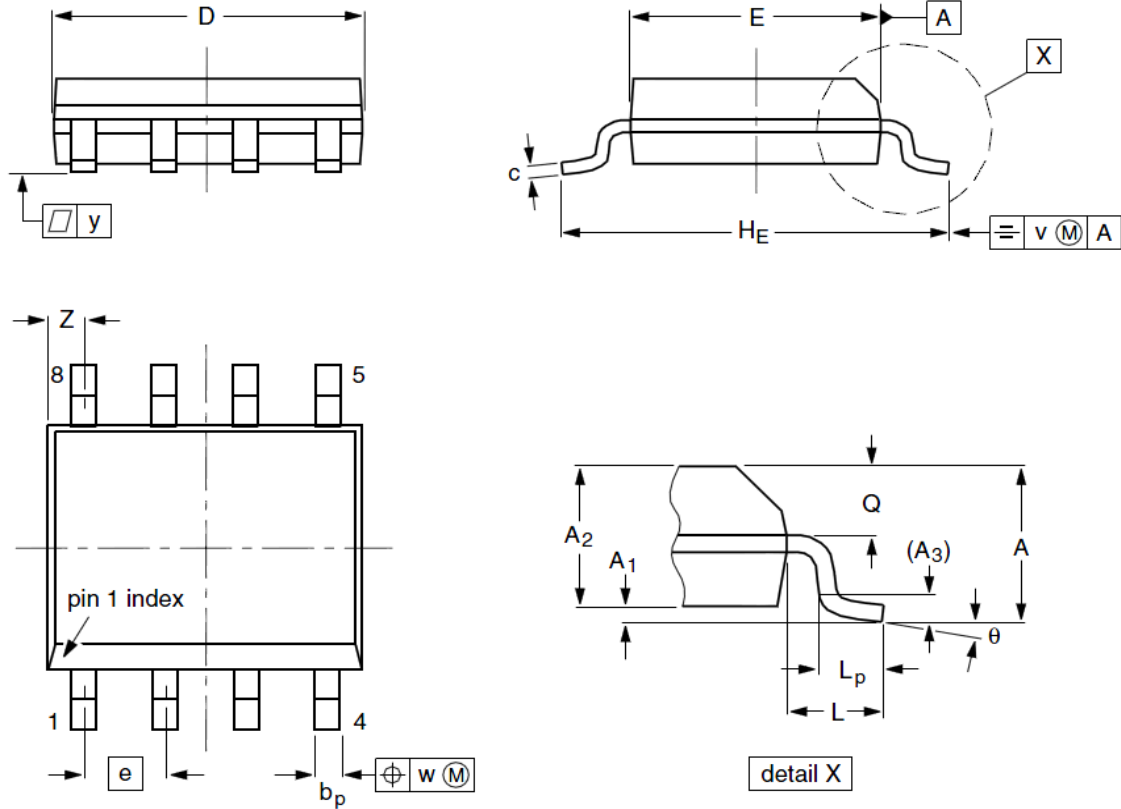
**Figure 2 Drain Current**

**Figure 3 Output Characteristics**

**Figure 4 Drain-Source On-Resistance**

**Figure 5 Transfer Characteristics**

**Figure 6 Drain-Source On-Resistance**

**P-Channel Enhancement Mode MOSFET**

**Figure 7 Rdson vs Vgs**

**Figure 8 Capacitance vs Vds**

**Figure 9 Gate Charge**

**Figure 10 Source- Drain Diode Forward**

**Figure 11 Normalized Maximum Transient Thermal Impedance**

**P-Channel Enhancement Mode MOSFET**
**SOP-8 Package Outline Dimensions**

Symbol	Dimensions (unit:mm)			Symbol	Dimensions (unit:mm)		
	Min	Typ	Max		Min	Typ	Max
<b>A</b>	1.35	1.55	1.75	<b>A<sub>1</sub></b>	0.10	0.18	0.25
<b>A<sub>2</sub></b>	1.25	1.45	1.65	<b>A<sub>3</sub></b>	--	0.25	--
<b>b<sub>p</sub></b>	0.36	0.42	0.51	<b>c</b>	0.19	0.22	0.25
<b>D</b>	4.70	4.92	5.10	<b>E</b>	3.80	3.90	4.00
<b>e</b>	--	1.27	--	<b>H<sub>E</sub></b>	5.80	6.00	6.20
<b>L</b>	--	1.05	--	<b>L<sub>p</sub></b>	0.40	0.68	1.00
<b>Q</b>	0.60	0.65	0.73	<b>v</b>	--	0.25	--
<b>w</b>	--	0.25	--	<b>y</b>	--	0.10	--
<b>Z</b>	0.30	0.50	0.70	<b>θ</b>	0°		8°