

P-Channel Enhancement Mode MOSFET

Features

- Low $R_{ds(on)}$ for low conduction loss
- Reliable and Rugged
- ROHS Compliant & Halogen-Free

Applications

- Power Management in Desktop Computer
- DC/DC Converters

Pin Description

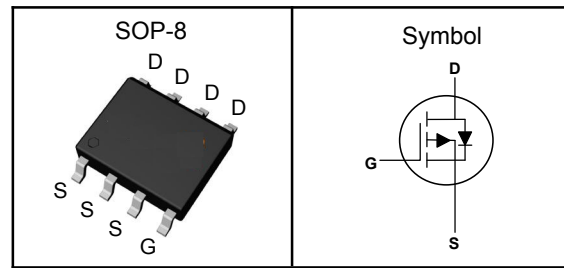

V_{bss}	-30	V
$R_{ds(ON)-Typ}$	20	m Ω
I_D	-9.3	A

Absolute Maximum Ratings ($T_A=25^\circ\text{C}$, Unless Otherwise Noted)

Symbol	Parameter	P-Channel	Unit
V_{bss}	Drain-Source Voltage	-30	V
V_{GSS}	Gate-Source Voltage	± 20	V
T_J	Maximum Junction Temperature	-55 to 150	$^\circ\text{C}$
T_{STG}	Storage Temperature Range	-55 to 150	$^\circ\text{C}$
$I_{DM}^{①}$	Pulse Drain Current Tested	-37	A
I_D	Continuous Drain Current	-9.3	A
P_D	Maximum Power Dissipation	$T_A=25^\circ\text{C}$ 3.1	W
E_{AS}	Single Pulse Avalanche Energy ^③ (L=0.3mH)	38	mJ

Thermal Characteristics

Symbol	Parameter	Rating	Unit
$R_{\theta JA}^{②}$	Thermal Resistance Junction-Ambient ^①	75	$^\circ\text{C}/\text{W}$
$R_{\theta JL}$	Thermal Resistance-Junction to Lead	24	$^\circ\text{C}/\text{W}$

Note ① : Max. current is limited by bonding wire.

Note ② : UIS tested and pulse width are limited by maximum junction temperature 150 $^\circ\text{C}$.

Note ③ : Surface Mounted on 1in² FR-4 board with 1oz.



P-Channel Enhancement Mode MOSFET

Electrical Characteristics ($T_J=25^{\circ}\text{C}$, Unless Otherwise Noted)

Symbol	Parameter	Test Conditions	Min	Typ	Max	Unit
Static Electrical Characteristics						
BV_{DSS}	Drain-Source Breakdown Voltage	$V_{GS}=0V, I_D=-250\mu A$	-30	---	---	V
I_{DSS}	Zero Gate Voltage Drain Current	$V_{DS}=-24V, V_{GS}=0V$	---	---	-1	μA
$V_{GS(th)}$	Gate Threshold Voltage	$V_{DS}=V_{GS}, I_D=-250\mu A$	-1.3	---	-2.3	V
I_{GSS}	Gate Leakage Current	$V_{GS}=\pm 20V, V_{DS}=0V$	---	---	± 100	nA
$R_{DS(on)}$	Drain-Source On-state Resistance	$V_{GS}=-10V, I_D=-9.3A$	---	20	24	$m\Omega$
		$V_{GS}=-4.5V, I_D=-4A$	---	30	38	$m\Omega$
Dynamic Characteristics ^⑤						
C_{iss}	Input Capacitance	$V_{GS}=0V, V_{DS}=-15V, \text{Freq.}=1\text{MHz}$	---	840	---	pF
C_{oss}	Output Capacitance		---	150	---	
C_{rss}	Reverse Transfer Capacitance		---	110	---	
$T_{d(on)}$	Turn-on Delay Time	$V_{DD}=-15V, I_D=-1A, V_{GS}=-10V, R_G=6\Omega, R_L=15\Omega$	---	7.5	---	nS
T_r	Turn-on Rise Time		---	8	---	
$T_{d(off)}$	Turn-off Delay Time		---	37	---	
T_f	Turn-off Fall Time		---	16	---	
Q_g	Total Gate Charge	$V_{DS}=-15V, V_{GS}=-10V, I_D=-9.3A$	---	18	---	nC
Q_{gs}	Gate-Source Charge		---	3	---	
Q_{gd}	Gate-Drain Charge		---	4	---	
Source-Drain Characteristics ($T_J=25^{\circ}\text{C}$)						
V_{SD}	Diode Forward Voltage _z	$V_{GS}=0V, I_S=-2A, T_J=25^{\circ}\text{C}$	---	0.75	1.0	V
t_{rr}	Reverse Recovery Time	$I_F=-9.3A, di/dt=100A/\mu s, T_J=25^{\circ}\text{C}$	---	19	---	nS
Q_{rr}	Reverse Recovery Charge		---	9	---	nC

Note ④ : Pulse test (pulse width $\leq 300\mu s$, duty cycle $\leq 2\%$).

Note ⑤ : Guaranteed by design, not subject to production testing.

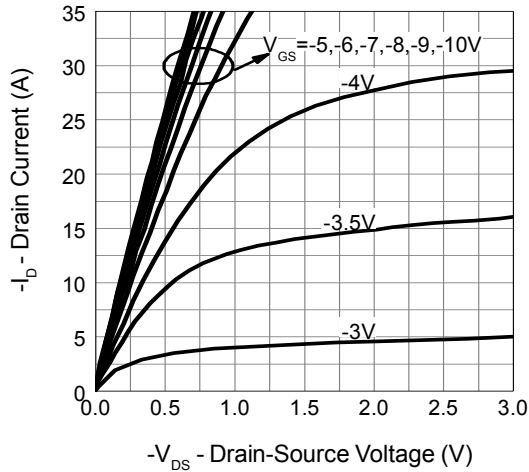
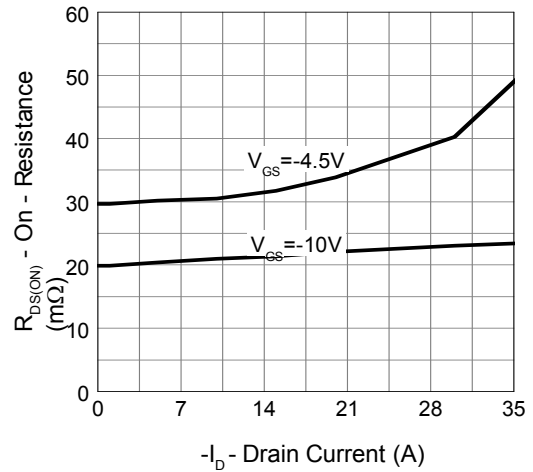
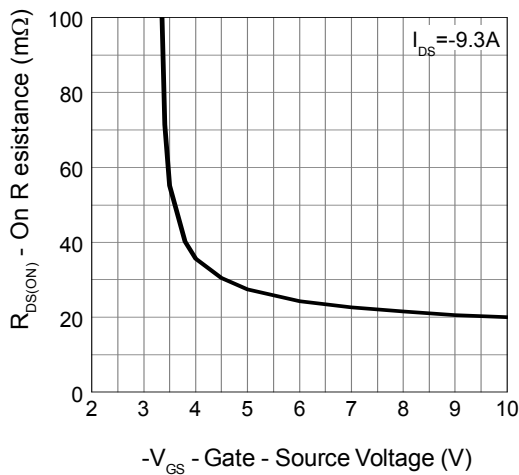
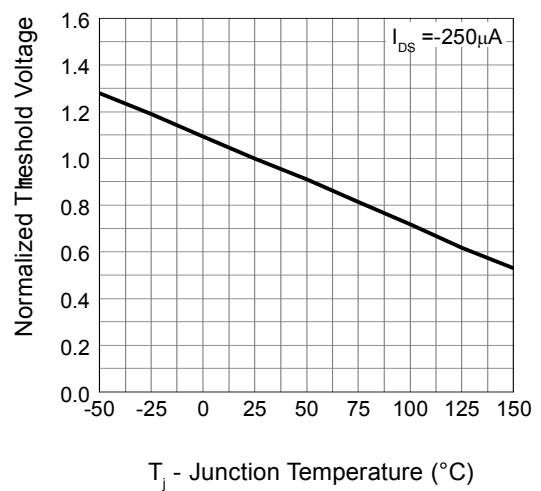
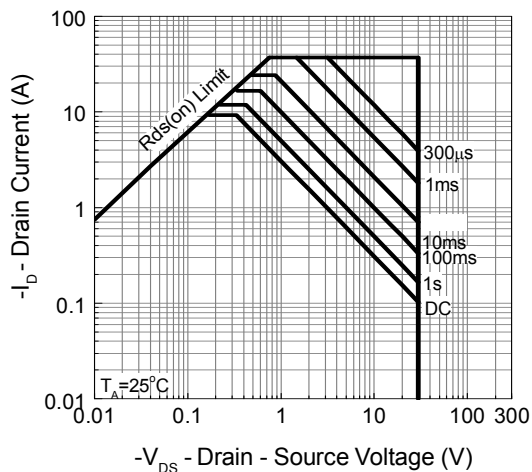
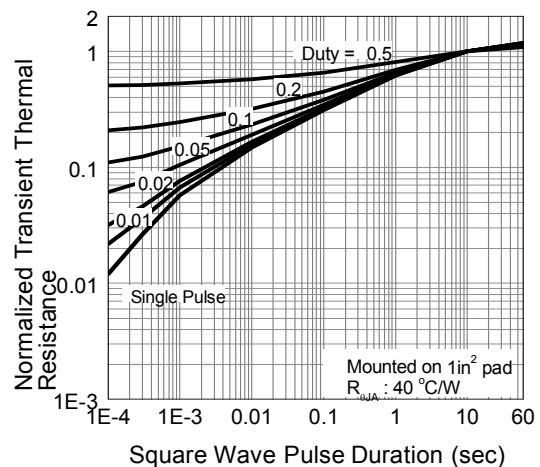
P-Channel Enhancement Mode MOSFET
Typical Characteristics
Output Characteristics

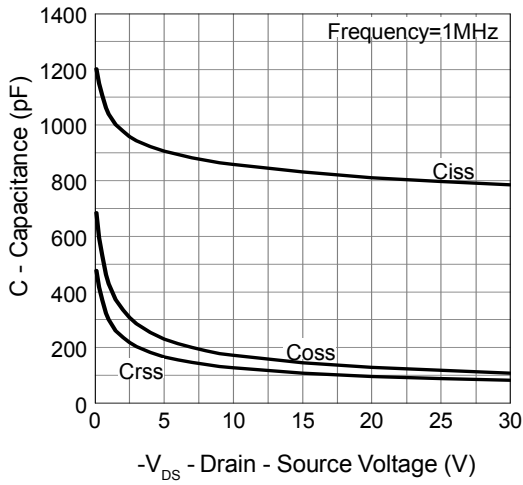
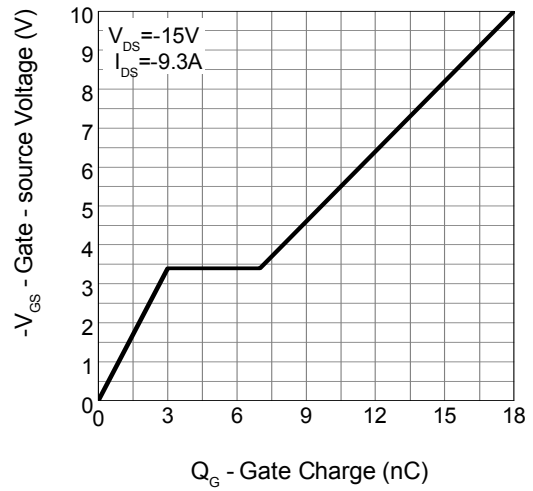
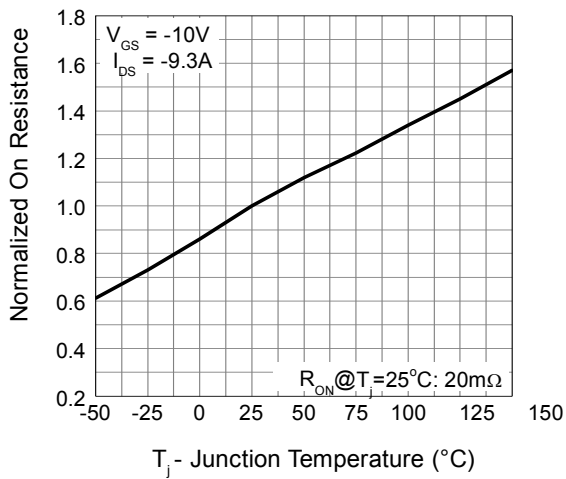
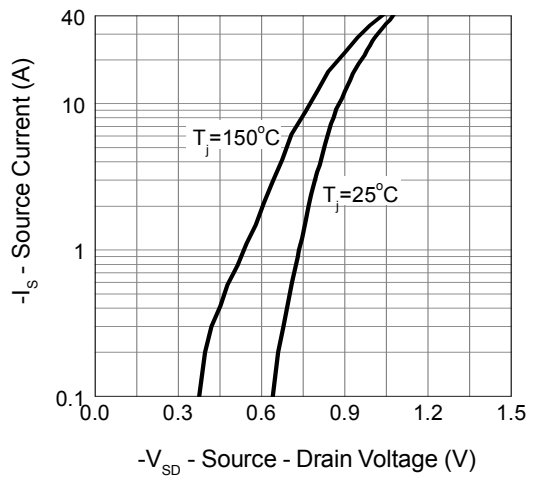
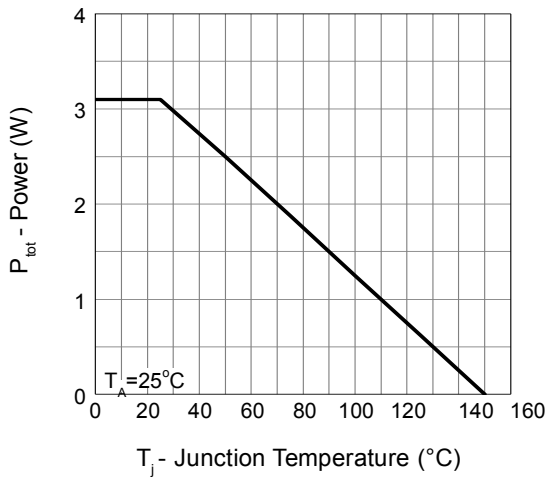
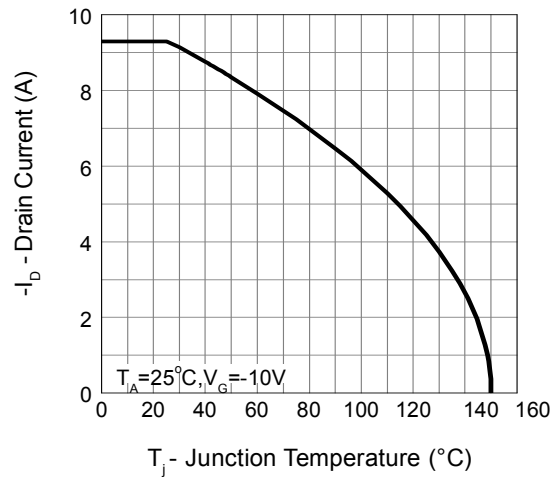
Drain-Source On Resistance

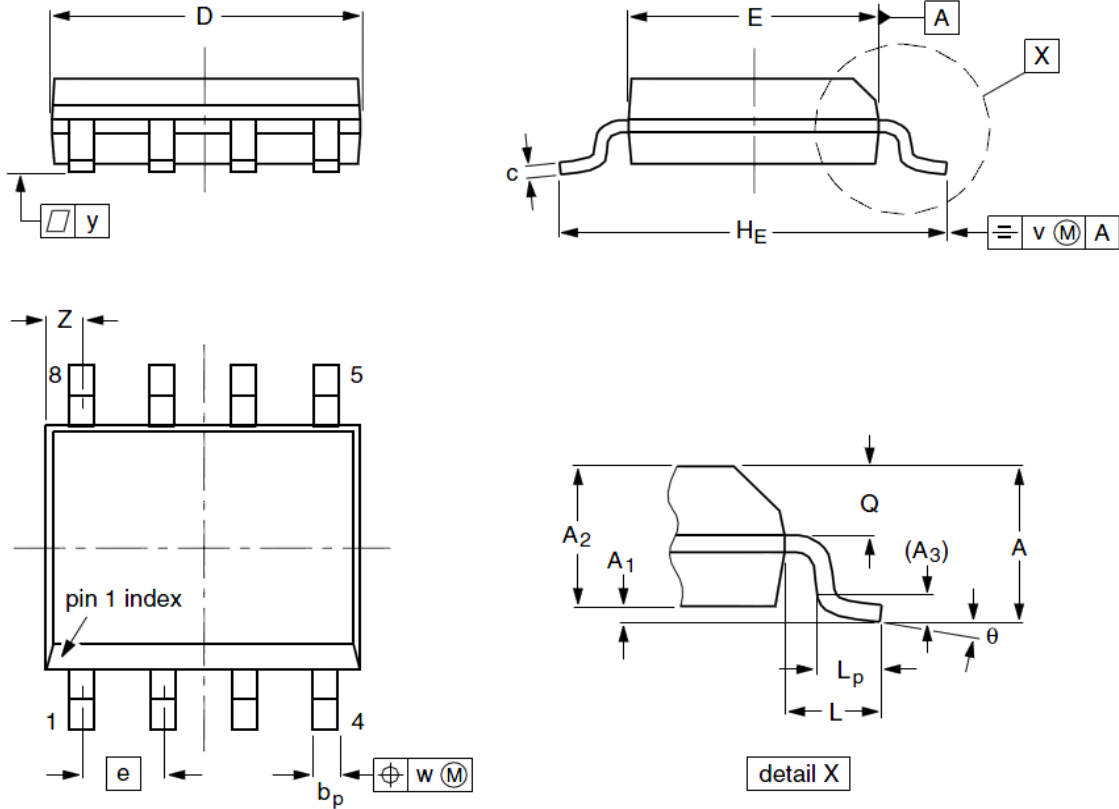
Gate-Source On Resistance

Gate Threshold Voltage

Safe Operation Area

Thermal Transient Impedance

P-Channel Enhancement Mode MOSFET
Capacitance

Gate Charge

Drain-Source On Resistance

Source-Drain Diode Forward

Power Dissipation

Drain Current

P-Channel Enhancement Mode MOSFET
SOP-8 Package Outline Dimensions

Symbol	Dimensions (unit:mm)			Symbol	Dimensions (unit:mm)		
	Min	Typ	Max		Min	Typ	Max
A	1.35	1.55	1.75	A₁	0.10	0.18	0.25
A₂	1.25	1.45	1.65	A₃	--	0.25	--
b_p	0.36	0.42	0.51	c	0.19	0.22	0.25
D	4.70	4.92	5.10	E	3.80	3.90	4.00
e	--	1.27	--	H_E	5.80	6.00	6.20
L	--	1.05	--	L_p	0.40	0.68	1.00
Q	0.60	0.65	0.73	v	--	0.25	--
w	--	0.25	--	y	--	0.10	--
Z	0.30	0.50	0.70	θ	0°		8°