

## N-Channel Enhancement Mode MOSFET

### Features

- Fast switching speed
- Reliable and Rugged
- ROHS Compliant
- 100% UIS and Rg Tested

### Applications

- Power Management in Desktop Computer
- DC/DC Converters

### Pin Description

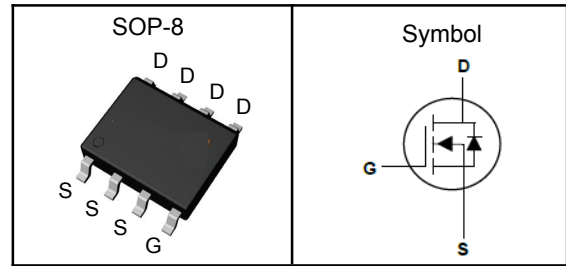

$V_{DSS}$	60	V
$R_{DS(ON)-Typ}$	7.5	m $\Omega$
$I_D$	12	A

### Absolute Maximum Ratings ( $T_A=25^\circ\text{C}$ , Unless Otherwise Noted)

Symbol	Parameter	N-Channel	Unit
$V_{DSS}$	Drain-Source Voltage	60	V
$V_{GSS}$	Gate-Source Voltage	$\pm 20$	V
$T_J$	Maximum Junction Temperature	-55 to 150	$^\circ\text{C}$
$T_{STG}$	Storage Temperature Range	-55 to 150	$^\circ\text{C}$
$E_{AS}$	Single Pulse Avalanche Energy L=0.5mH	64	mJ
$I_{DM}^{①}$	Pulse Drain Current Tested	40	A
$I_D$	Continuous Drain Current	$T_A=25^\circ\text{C}$	A
$P_D$	Maximum Power Dissipation	$T_A=25^\circ\text{C}$	W

### Thermal Characteristics

Symbol	Parameter	Rating	Unit
$R_{\theta JA}$	Thermal Resistance Junction-Ambient <sup>①</sup>	50	$^\circ\text{C}/\text{W}$

Note ① : Max. current is limited by bonding wire.

Note ② : UIS tested and pulse width are limited by maximum junction temperature 150 $^\circ\text{C}$ .

Note ③ : Surface Mounted on 1in<sup>2</sup> FR-4 board with 1oz.



**N-Channel Enhancement Mode MOSFET**

**Electrical Characteristics** ( $T_J=25^{\circ}\text{C}$ , Unless Otherwise Noted)

Symbol	Parameter	Test Conditions	Min	Typ	Max	Unit
<b>Static Electrical Characteristics</b>						
$BV_{DSS}$	Drain-Source Breakdown Voltage	$V_{GS}=0V, I_D=250\mu A$	60	---	---	V
$I_{DSS}$	Zero Gate Voltage Drain Current	$V_{DS}=48V, V_{GS}=0V$	---	---	1	$\mu A$
$V_{GS(th)}$	Gate Threshold Voltage	$V_{DS}=V_{GS}, I_D=250\mu A$	1.0	---	2.5	V
$I_{GSS}$	Gate Leakage Current	$V_{GS}=\pm 20V, V_{DS}=0V$	---	---	$\pm 100$	nA
$R_{DS(on)}$	Drain-Source On-state Resistance	$V_{GS}=10V, I_D=4A$	---	7.5	10	m $\Omega$
		$V_{GS}=4.5V, I_D=3A$	---	11.5	14.7	
<b>Dynamic Characteristics</b> <sup>⑤</sup>						
$C_{iss}$	Input Capacitance	$V_{GS}=0V, V_{DS}=30V, \text{Freq.}=1\text{MHz}$	---	1225	---	pF
$C_{oss}$	Output Capacitance		---	235	---	
$C_{rss}$	Reverse Transfer Capacitance		---	30	---	
$T_{d(on)}$	Turn-on Delay Time	$V_{DD}=30V, V_{GEN}=10V, R_L=30\Omega, R_G=6\Omega, I_D=1A$	---	14	---	nS
$T_r$	Turn-on Rise Time		---	6	---	
$T_{d(off)}$	Turn-off Delay Time		---	29	---	
$T_f$	Turn-off Fall Time		---	26	---	
$Q_g$	Total Gate Charge	$V_{DD}=30V, V_{GS}=10V, I_D=4A$	---	20.3	---	nC
$Q_{gs}$	Gate-Source Charge		---	3.5	---	
$Q_{gd}$	Gate-Drain Charge		---	2.8	---	
<b>Source-Drain Characteristics</b> ( $T_J=25^{\circ}\text{C}$ )						
$V_{SD}$	Diode Forward Voltage <sub>z</sub>	$V_{GS}=0V, I_{SD}=2A, T_J=25^{\circ}\text{C}$	---	0.8	1.3	V
$t_{rr}$	Reverse Recovery Time	$I_{SD}=4A, di/dt=100A/\mu s, T_J=25^{\circ}\text{C}$	---	28	---	nS
$Q_{rr}$	Reverse Recovery Charge		---	23	---	nC

Note ④ : Pulse test (pulse width $\leq$ 300 $\mu$ s, duty cycle $\leq$ 2%).

Note ⑤ : Guaranteed by design, not subject to production testing.

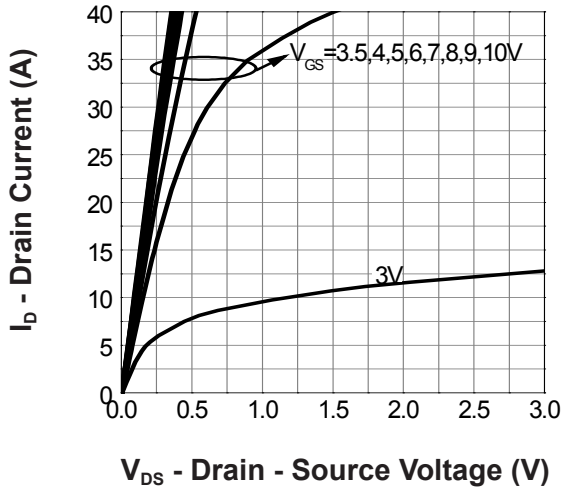
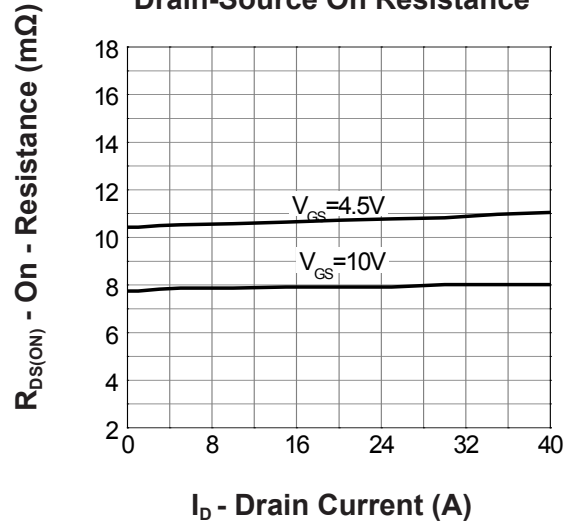
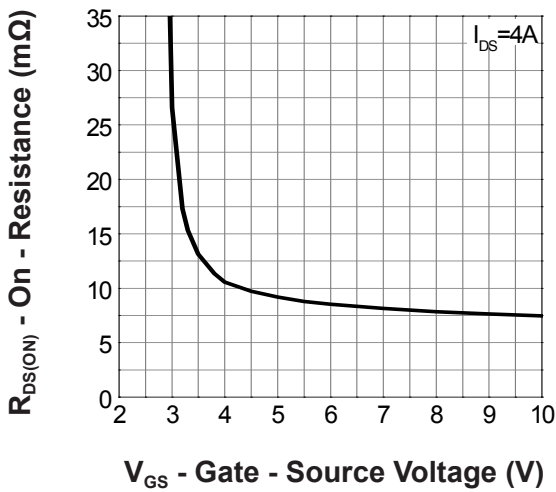
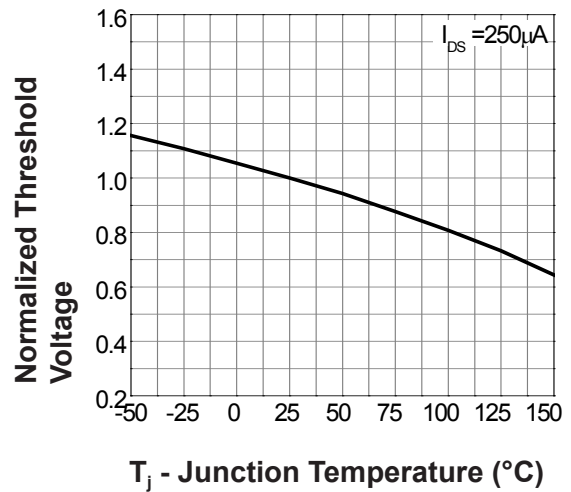
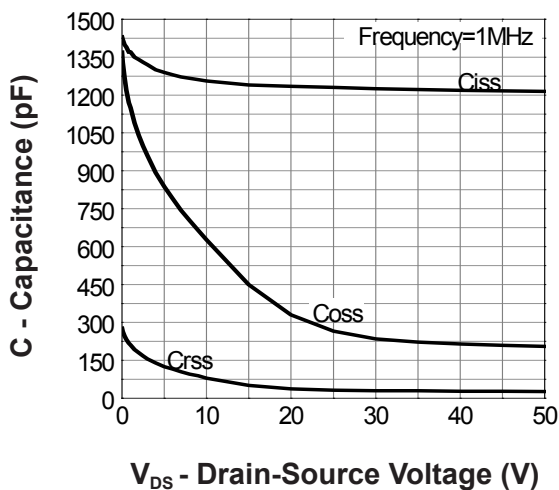
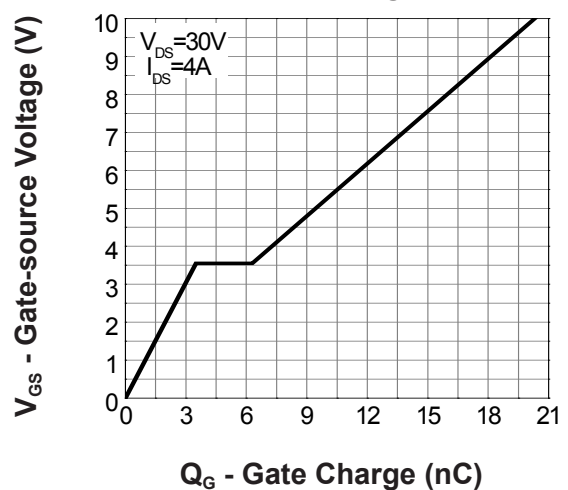
**N-Channel Enhancement Mode MOSFET**
**Typical Characteristics**
**Output Characteristics**

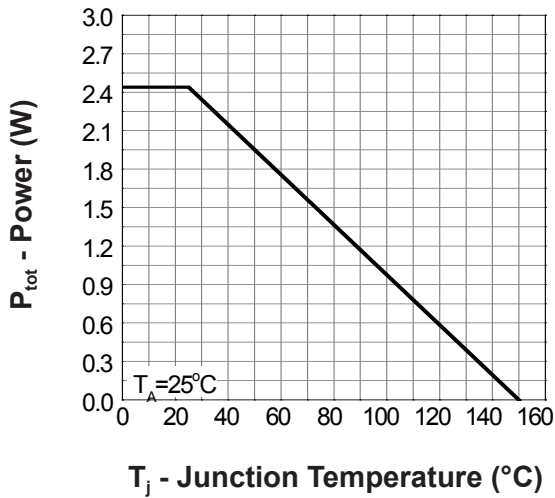
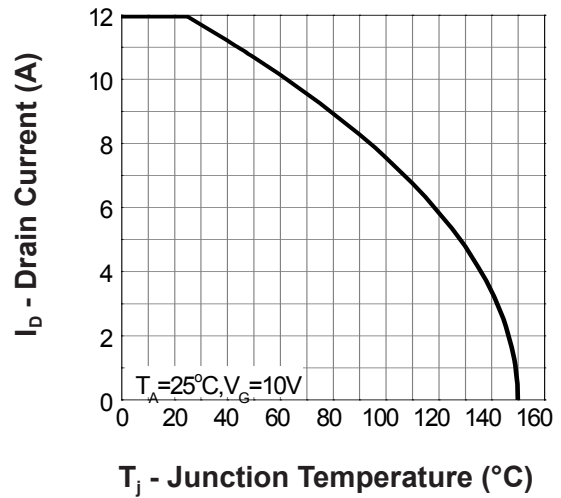
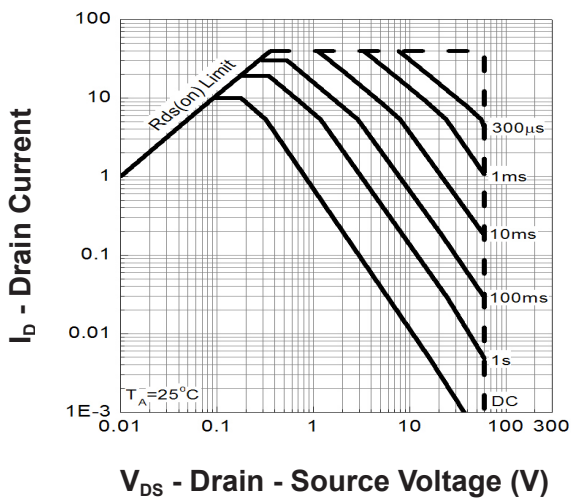
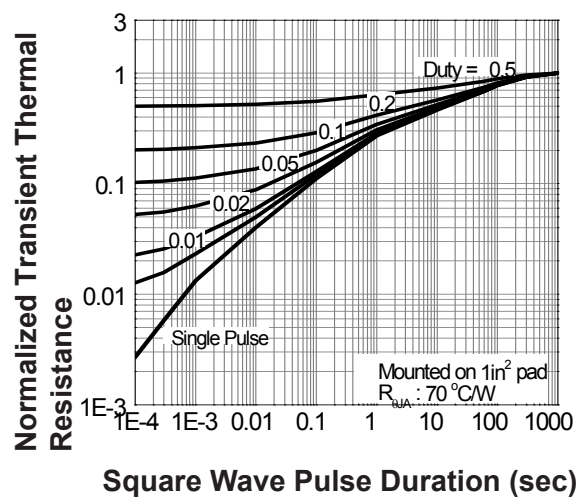
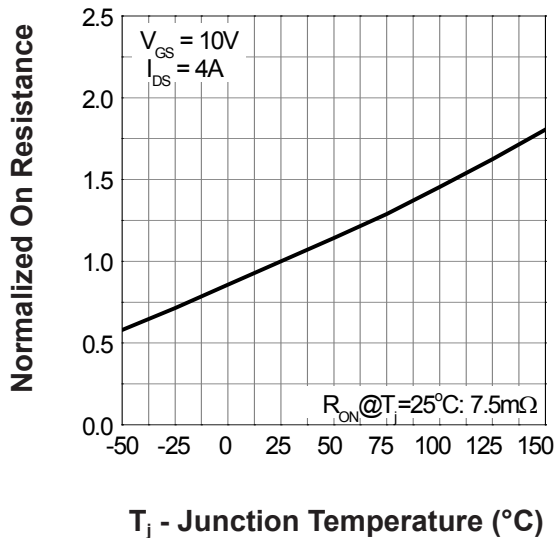
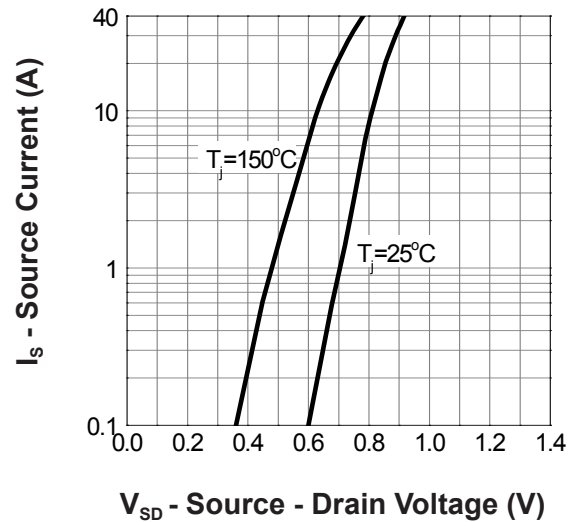
**Drain-Source On Resistance**

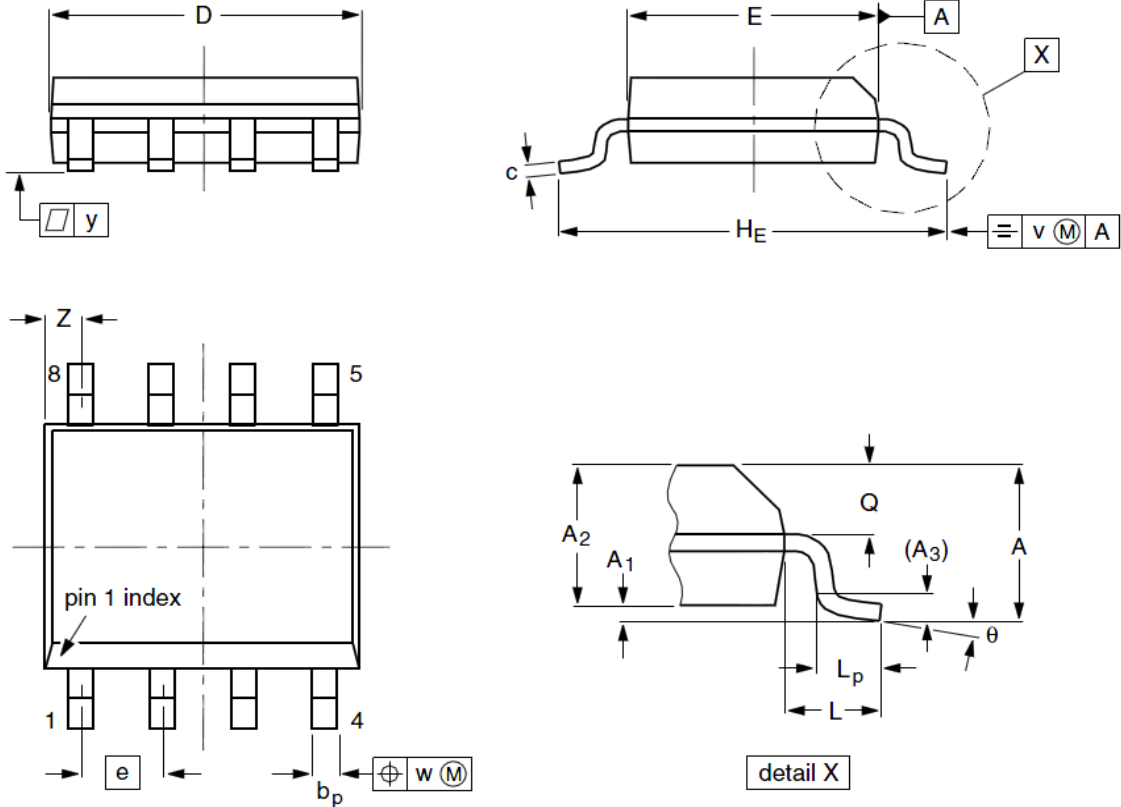
**Gate-Source On Resistance**

**Gate Threshold Voltage**

**Capacitance**

**Gate Charge**

**N-Channel Enhancement Mode MOSFET**
**Power Dissipation**

**Drain Current**

**Safe Operation Area**

**Thermal Transient Impedance**

**Drain-Source On Resistance**

**Source-Drain Diode Forward**

**N-Channel Enhancement Mode MOSFET**
**SOP-8 Package Outline Data**

Symbol	Dimensions (unit:mm)			Symbol	Dimensions (unit:mm)		
	Min	Typ	Max		Min	Typ	Max
<b>A</b>	1.35	1.55	1.75	<b>A<sub>1</sub></b>	0.10	0.18	0.25
<b>A<sub>2</sub></b>	1.25	1.45	1.65	<b>A<sub>3</sub></b>	--	0.25	--
<b>b<sub>p</sub></b>	0.36	0.42	0.51	<b>c</b>	0.19	0.22	0.25
<b>D</b>	4.70	4.92	5.10	<b>E</b>	3.80	3.90	4.00
<b>e</b>	--	1.27	--	<b>H<sub>E</sub></b>	5.80	6.00	6.20
<b>L</b>	--	1.05	--	<b>L<sub>p</sub></b>	0.40	0.68	1.00
<b>Q</b>	0.60	0.65	0.73	<b>v</b>	--	0.25	--
<b>w</b>	--	0.25	--	<b>y</b>	--	0.10	--
<b>Z</b>	0.30	0.50	0.70	<b>θ</b>	0°		8°