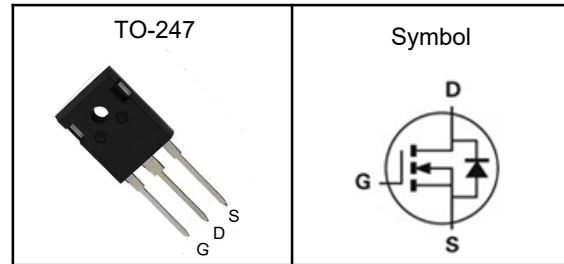

N-Channel Enhancement Mode MOSFET
Features

- Low $R_{ds(on)}$ for low conduction loss
- Reliable and Rugged
- ROHS Compliant & Halogen-Free

Applications

- Power Management in Desktop Computer
- DC/DC Converters

Pin Description

V_{DSS}	100	V
$R_{DS(ON)-Typ}$	1.7	m Ω
I_D	280	A

Absolute Maximum Ratings($T_C=25^\circ\text{C}$, unless otherwise noted)

Parameter	Symbol	Rating	Units
Drain-Source Voltage	V_{DS}	100	V
Gate-Source Voltage	V_{GS}	± 20	V
Continuous Drain Current ¹	I_D	280	A
Continuous Drain Current ¹	I_D	181	A
Pulsed Drain Current ²	I_{DM}	980	A
Single Pulse Avalanche Energy ³	E_{AS}	590	mJ
Total Power Dissipation ⁴	P_D	205	W
Storage Temperature Range	T_{STG}	-55 to 175	$^\circ\text{C}$
Operating Junction Temperature Range	T_J	-55 to 175	$^\circ\text{C}$

Thermal Characteristics

Parameter	Symbol	Typ	Max	Unit
Thermal Resistance Junction-Ambient ¹	$R_{\theta JA}$	---	62.5	$^\circ\text{C}/\text{W}$
Thermal Resistance Junction-Case ¹	$R_{\theta JC}$	---	0.3	$^\circ\text{C}/\text{W}$

**N-Channel Enhancement Mode MOSFET****Electrical Characteristics ($T_J=25^{\circ}\text{C}$, unless otherwise noted)**

Parameter	Symbol	Conditions	Min	Typ	Max	Unit
Drain-Source Breakdown Voltage	BV_{DSS}	$V_{GS}=0V, I_D=250\mu A$	100	---	---	V
Static Drain-Source On-Resistance	$R_{DS(ON)}$	$V_{GS}=10V, I_D=50A$	---	1.7	2.1	$m\Omega$
Gate Threshold Voltage	$V_{GS(th)}$	$V_{GS}=V_{DS}, I_D=250\mu A$	2	---	4	V
Drain-Source Leakage Current	I_{DSS}	$V_{DS}=80V, V_{GS}=0V$	---	---	1	μA
Gate-Source Leakage Current	I_{GSS}	$V_{GS}=\pm 20V, V_{DS}=0V$	---	---	± 100	nA
Total Gate Charge	Q_g	$V_{DS}=50V, V_{GS}=10V, I_D=50A$	---	243	---	nC
Gate-Source Charge	Q_{gs}		---	75	---	
Gate-Drain Charge	Q_{gd}		---	67	---	
Turn-On Delay Time	$T_{d(on)}$	$V_{DS}=50V, V_{GS}=10V, R_G=3.9\Omega, I_D=50A$	---	42	---	ns
Rise Time	T_r		---	155	---	
Turn-Off Delay Time	$T_{d(off)}$		---	150	---	
Fall Time	T_f		---	145	---	
Input Capacitance	C_{iss}	$V_{DS}=50V, V_{GS}=0V, f=1MHz$	---	13400	---	pF
Output Capacitance	C_{oss}		---	2000	---	
Reverse Transfer Capacitance	C_{rss}		---	135	---	

Drain-Source Diode Characteristics

Parameter	Symbol	Conditions	Min	Typ	Max	Unit
Continuous Source Current ¹	I_S		---	---	280	A
Diode Forward Voltage ²	V_{SD}	$V_{GS}=0V, I_S=50A, T_J=25^{\circ}\text{C}$	---	---	1.3	V

Note:

- 1.The data tested by surface mounted on a 1 inch²FR-4 board with 2OZ copper.
- 2.The data tested by pulsed , pulse width $\leq 300\mu s$, duty cycle $\leq 2\%$
- 3.The EAS data shows Max. rating . The test condition is $V_{DD}=100V, R_G=25\Omega, L=0.1mH$

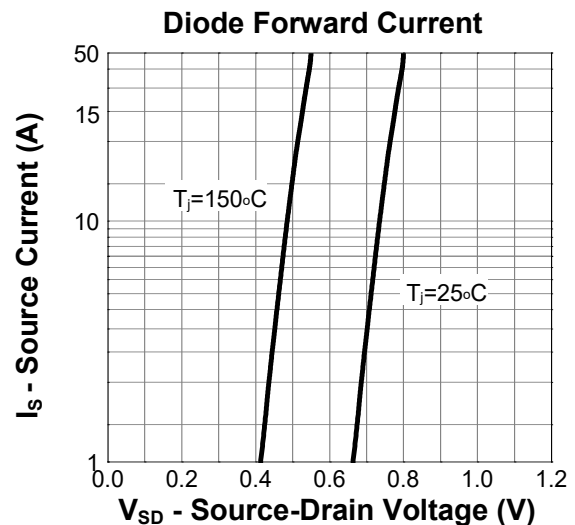
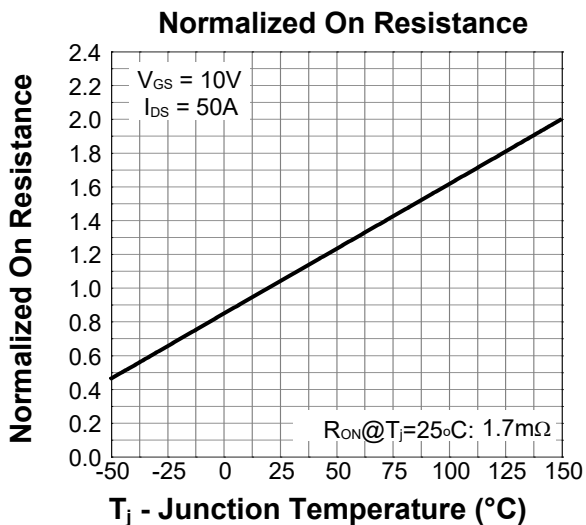
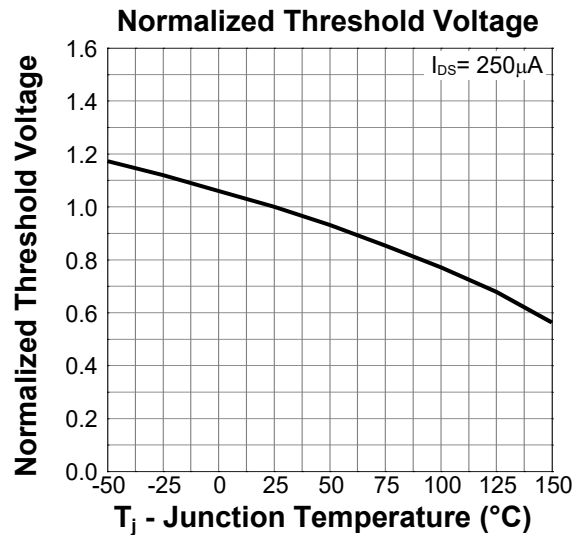
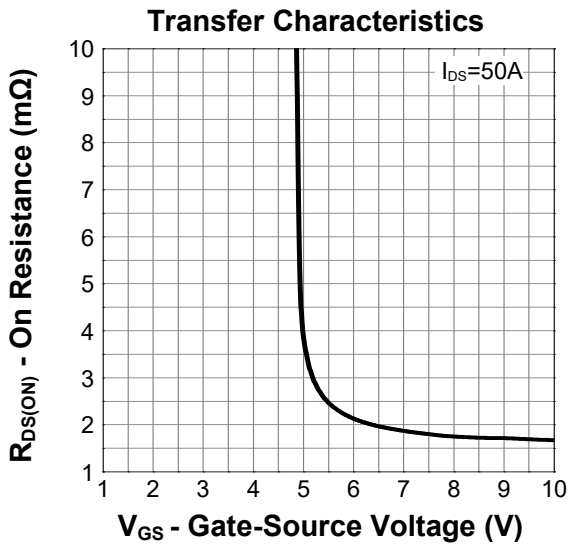
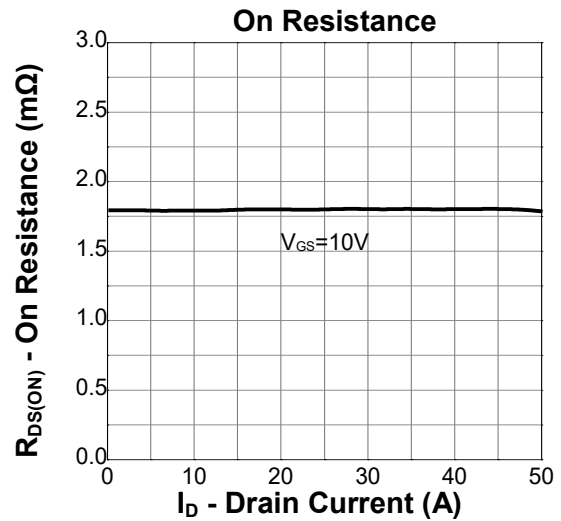
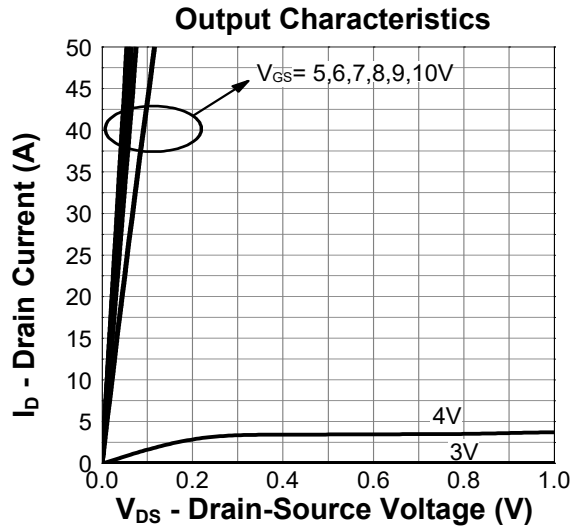
N-Channel Enhancement Mode MOSFET
Typical Characteristics

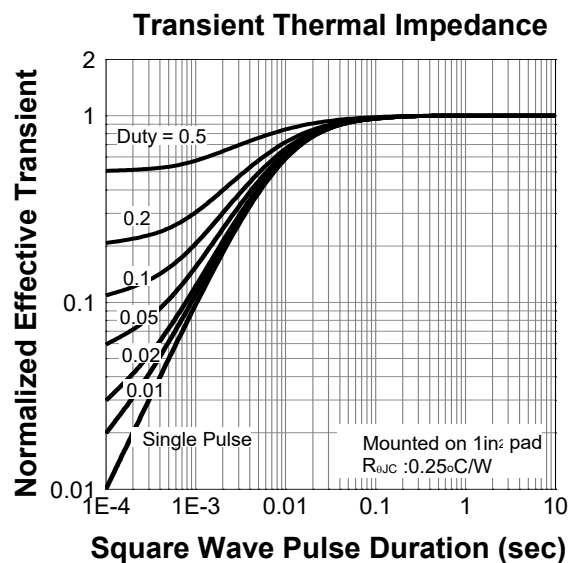
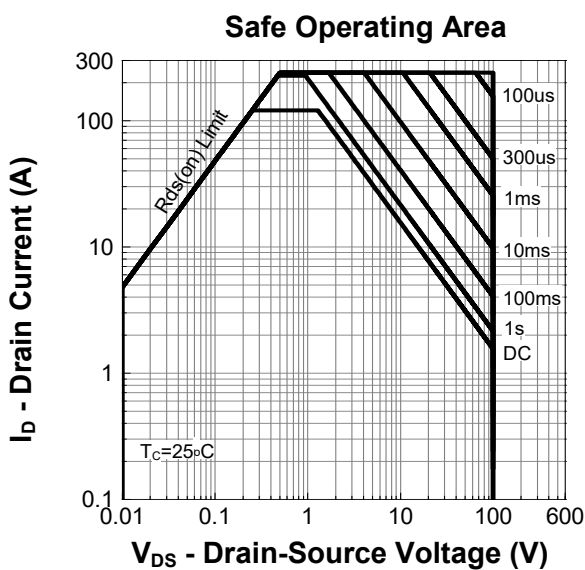
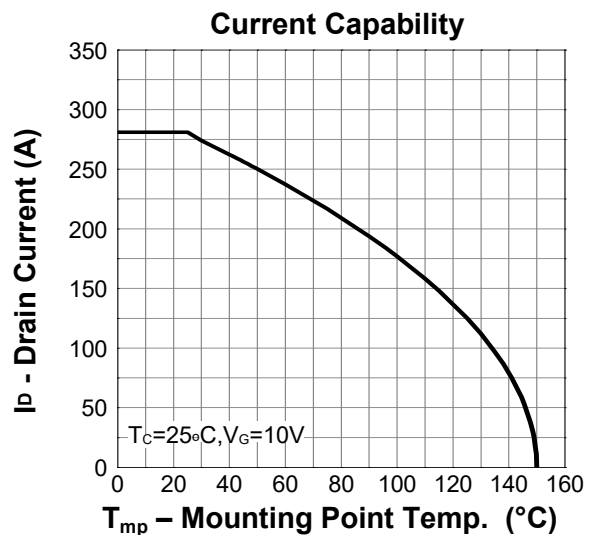
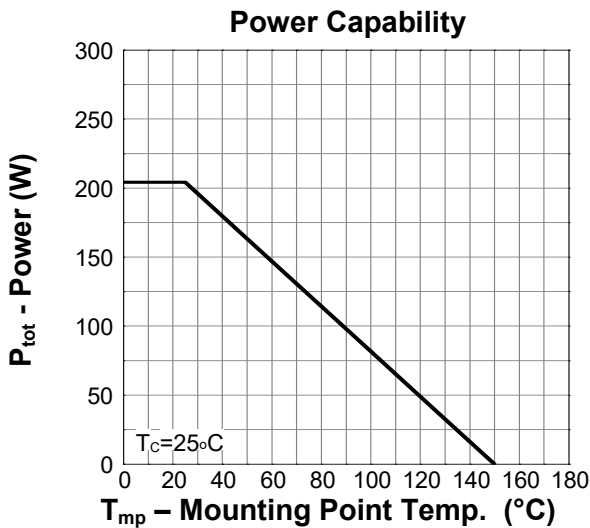
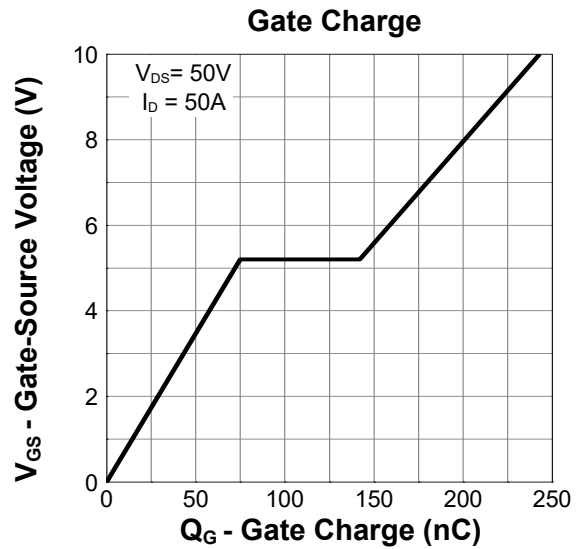
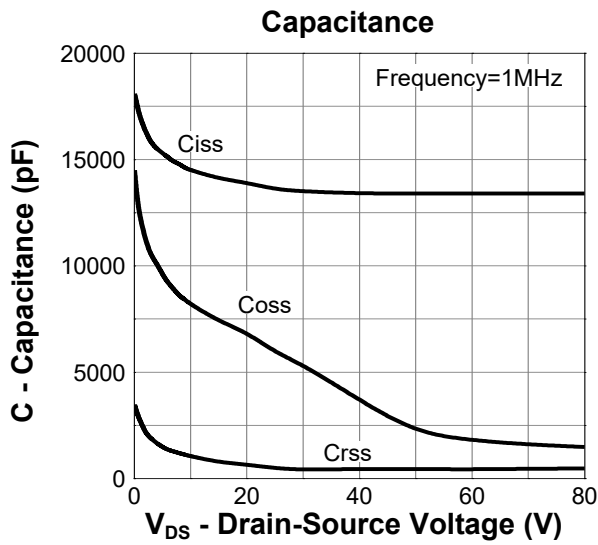
N-Channel Enhancement Mode MOSFET

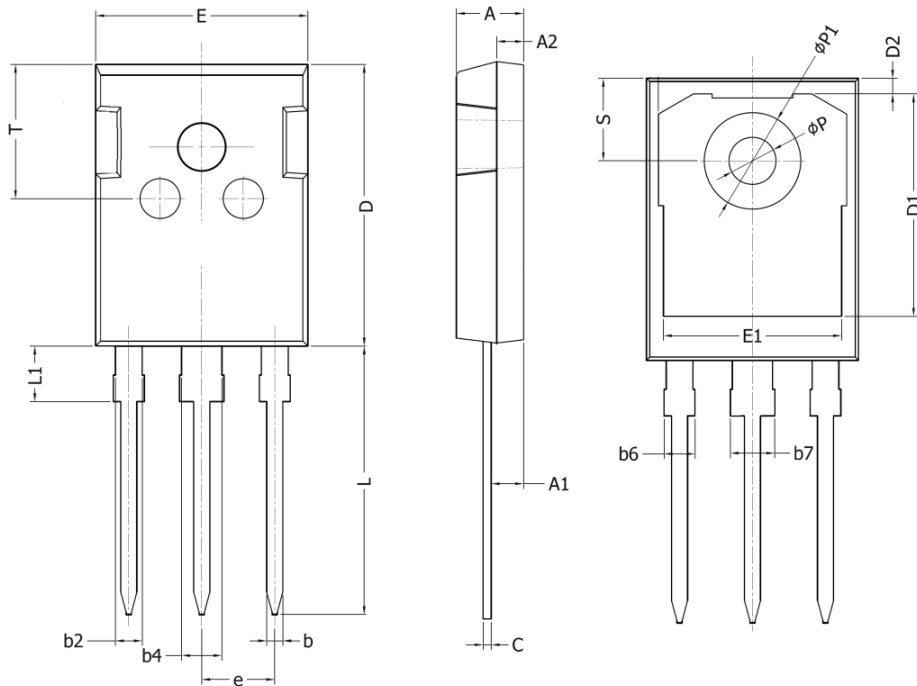
N-Channel Enhancement Mode MOSFET
TO-247 Package Outline Dimensions

Symbol	Dimensions In Millimeters	
	Min.	Max.
A	4.90	5.20
A1	2.31	2.51
A2	1.9	2.1
b	1.16	1.26
b2	1.96	2.06
b4	2.96	3.06
b6	-	2.25
b7	-	3.25
C	0.59	0.66
D	20.90	21.20
D1	16.25	16.85
D2	1.05	1.35
E	15.75	16.10
E1	13.00	13.60
e	5.436 BSC	
L	19.80	20.20
L1	-	4.30
P	3.40	3.60
P1	7.00	7.40
S	6.05	6.25
T	9.80	10.20